

International Council For Scientific Development  
INTERNATIONAL ACADEMY OF SCIENCE  
H&E



# SCIENCE WITHOUT BORDERS

Transactions  
of the International Academy of Science  
H&E

Volume 4  
2017-2019



Innsbruck

International Council For Scientific Development  
INTERNATIONAL ACADEMY OF SCIENCE  
H&E



# SCIENCE WITHOUT BORDERS

**Transactions  
of the International Academy of Science  
H&E**

**Volume 4  
2017/2019**

It is devoted to the 60 anniversary of  
Academician, Professor, Dr.  
Elchin Nusrat Khalilov  
and  
to the 15th anniversary of the Azerbaijan Section of  
ICSD/IAS-AS H&E

**Innsbruck – 2019**

## EDITORIAL BOARD

### Co-chairs

**Academician, Prof. Dr.  
Walter Kofler, President of  
ICSD/IAS H&E  
(Innsbruck, Austria)**

**Academician,  
Prof. Dr. Elchin Khalilov,  
President of ICSD/IAS-AS  
H&E (Baku, Azerbaijan)**

### MEMBERS OF EDITORIAL BOARD:

Akad. Prof. Dr. R. Steinacker (meteorology), Austria; Acad. Prof. Dr. K. Hecht (medicine), Germany; Acad. Prof. Dr. G. Tellnes (medicine), Norway; Acad. Prof. Dr. Z. Samedzade (economy), Azerbaijan; Prof. Dr. Wang Lanmin (seismology), China; Acad. Prof. Dr. V. Starostenko (geophysics), Ukraine; Acad. Prof. Dr. P. Z. Mamedov (geophysics), Azerbaijan; Acad. Prof. Dr. R.Lobato (journalism), Brazil; Acad. Prof. Dr. O.Glazachev (medicine), Russia; Acad. Prof. Dr. G.Fumarola (ecology), Italy; Acad. Prof. Dr. M.Gigolashvili (astrophysics), Georgia; Acad. Prof. Dr. M. N. Veliyeva (pharmaceuticals), Azerbaijan; Acad. Dr. P.Keshavan (biology), India;

### **Science Without Borders. Transactions of the International Academy of Science H&E. Vol. 4, Innsbruck, SWB, 2017/2019, 701 p.**

In the book are published the transactions of full members and corresponding members of the International Council For Scientific Development/International Academy of Science H&E, and the articles, presented by Academicians of ICSD/IAS H&E. The content of the book is multidisciplinary and covers the main spheres of modern natural and humanitarian sciences.

During selecting the articles to the book, the special priority was given to scientific researches, which are at the joint of different sciences.

This book is of interest for wide circles of scientists and students in different spheres of science.

© International Academy of Science H&E

ISSN 2070-0334

ISBN 978-9952-451-04-7

**SWB  
Innsbruck – 2019**

## CONTENTS

### PREFACE

60 ANNIVERSARY OF PROF. DR. ELCHIN KHALILOV .....9

FOREWORD .....15

### MULTIDISCIPLINARY RESEARCHIES

*Kofler W., Khalilov E.*

AN ATTEMPT TO INTEGRATE THE RELATIVITY  
THEORIES INTO A COMPREHENSIVE HEALTH  
ORIENTED MODEL ..... 16

### MEDICINE AND BIOLOGY

*Yoshihiko Watanabe, Kuniaki Otsuka, Germaine Cornelissen,  
Franz Halberg*

PERSONALIZED BLOOD PRESSURE CHRONOTHERAPY .....59

*Novoselova E.G.*

ZEOLITE-CONTAINING PRODUCTS OF “LITOVIIIT”  
SERIES RESEARCH OF SORPTION ACTIVITY ..... 65

*Karl Hecht*

CLINOPTILOLITE-ZEOLITE AND MONTMORILLONITE  
MINERALS RICH IN  $\text{SiO}_2$ : WHAT ARE THEY? WHAT CAN  
THEY ACHIEVE? WHY ARE THEY SO IMPORTANT  
FOR HUMAN HEALTH? .....71

*Alakbarova N.Y.*

CHANGES IN SOME INDICATORS OF IMMUNE  
STATUS AFTER SLIT IN CHILDREN  
WITH RESPIRATORY ALLERGIES ..... 99

*Musayev S.K., Hadyeva Sh.F.*

DEPENDENCE OF MORPHOLOGICAL CHANGES IN THE  
GASTRIC MUCOSA IN PATIENTS WITH RHEUMATOID  
ARTHRITIS ON THE DURATION OF THE PATHOLOGIC  
PROCESS .....108

*Veliyeva M., Veliyev P.*

ELABORATION OF PHARMACEUTICAL MEANS ON THE  
BASIS LICORICE OF THE REPUBLIC OF AZERBAIJAN .....112

*Veliyeva M.*

ABOUT BENEFICIAL FEATURES OF MEDICINAL  
PREPARATIONS OF LICORICE .....117

*Musayev A.F.*

**ASSESSMENT OF THE PERSONAL POTENTIAL'S  
PROFESSIONALISM LEVEL BY MODIFIED WEIGHTED  
SUM MODEL.....127**

*Gurbanova D.F., Ali-zada S.F., Huseynova S.A.*

**BALLON TAMPONADE AS A METHOD OF  
PREVENTION AND TREATMENT OF  
POSTPARTUM HAEMORRHAGE.....135**

*Christian Bartenbach*

**LIGHT AND HEALTH.....147**

*Glazachev O.S., Zapara M.A.*

**EFFECTS OF SYSTEMIC HYPERTHERMIA ON EXERCISE  
PERFORMANCE, ENDOCRINE STATUS AND QUALITY  
OF LIFE IN HEALTHY UNTRAINED VOLUNTEERS.....176**

## **PHYSICAL-MATHEMATICAL SCIENCES**

*Askerov Sh.G. , Khanjiqazov T.*

**ECONOPHYSICAL ANALYSIS OF ECONOMIC  
DEVELOPMENT.....195**

*Mahmudov E.N., Mastaliyeva D.I.*

**OPTIMAL CONTROL OF STURM-LIOUVILLE TYPE  
DIFFERENTIAL INCLUSIONS WITH FUNCTIONAL  
CONSTRAINTS.....203**

*Khalilov E.N.*

**EXPERIMENTAL RESEARCHES OF DYNAMICS  
OF WEIGHT OF TRIAL MASSES AND  
GRAVITATIONAL QUANTUM  
EFFECTS.....219**

*Guliyev R.*

**ON THE ORBITAL EVOLUTION AND ORIGIN OF COMET  
67P/CHURYUMOV–GERASIMENKO.....259**

*Abbasov A., Khalilov E.*

**"SATPAG" SPECIAL SYSTEM OF INFORMATION TRANSFER  
TO SEISMIC DISASTER AREAS.....266**

## EARTH SCIENCE, ECOLOGY

<i>Khalilov E., Wang L., Khalilova L.</i> <b>THE INFLUENCE OF GEODYNAMIC PROCESSES ON THE SAFETY OF INDUSTRIAL AND CIVIL FACILITIES OF AZERBAIJAN</b> .....	275
<i>Khalilov E., Kofler W.</i> <b>EARTHQUAKE AND TSUNAMI - CHALLENGES FOR THE APPLICATION ORIENTED EXTENDED VIEW</b> .....	285
<i>Sinan Melih Nigdeli</i> <b>ACTIVE BRACE CONTROL OF FRAME STRUCTURES UNDER EARTHQUAKE EXCITATION</b> .....	298
<i>Awais M., Shahid Riaz M., Zeeshan Jilani and Qaisar M.</i> <b>PRELIMINARY RESULTS OF ANALYSIS OF THERMAL SATELLITE AND GROUND BASED RADON DATA RECORDED PRIOR TO HARIPUR EARTHQUAKE, PAKISTAN</b> .....	308
<i>Garzon G., Silva B., Narvaez A., Chacon Z., Galle B.</i> <b>ASSESSMENT OF SO<sub>2</sub> EMISSIONS FROM THREE COLOMBIAN ACTIVE VOLCANOES</b> .....	316
<i>Kariche Jugurtha, Boughacha Mohamed Salah</i> <b>DISPLAYING OF THE FIELDS INDUCED BY A FAULT IN AN INTERACTIVE MODE: APPLICATION TO THE EL-ASNAM EARTHQUAKE (ALGERIA, 10/10/1980, M=7.2)</b> .....	326
<i>Starostenko V., Kendzera O., Legostaeva O., Farfuliak L.</i> <b>SEISMICITY AND SEISMIC PROTECTION IN UKRAINE</b> .....	334
<i>Andrei Bala, Alexandru Aldea, Stefan Florin Balan, Cristian Arion</i> <b>ASSESSMENT OF THE SEISMIC SITE EFFECTS BASED ON EARTHQUAKE RECORDINGS AND IN SITU BOREHOLE MEASUREMENTS IN BUCHAREST, ROMANIA</b> .....	343
<i>Goulopoulos Nikolaos</i> <b>RISING EARTHQUAKES: PRECURSOR OF VOLCANIC WINTERS/ICE AGE THAT WE MAY AVERT - OTHER NECESSARY PREPARATIONS</b> .....	354

*Svalova V.*

**MECHANICAL-MATHEMATICAL MODELING  
AND MONITORING FOR LANDSLIDES.....362**

*Batrak G., Semenov S., Seleznev S., Galitskaya I.*

**CONSIDERATION OF EXTREME HYDRO-GEOLOGICAL  
EVENTS IN NUMERICAL FORECASTS OF  
HYDRO-GEOLOGICAL CONDITIONS CHANGE IN  
THE TERRITORY OF IMPORTANT  
INFRASTRUCTURE OBJECTS.....372**

*André Francisco Pilon*

**RETURNING THE EARTH TO MANKIND AND MANKIND  
TO EARTH: AN ECOSYSTEMIC APPROACH  
TO ADVOCACY, PUBLIC POLICIES, RESEARCH  
AND TEACHING PROGRAMMES.....385**

*Smiljkovic Z., Dhawan A.K.*

**BASIC APPROACH FOR ANALYSIS OF EARTHQUAKE  
RESPONSE OF  
DAMS.....412**

*Khalilova L.N.*

**STUDY OF PRODUCTIVE SERIES DEPOSITS OF  
GUNASHLI FIELD IN THE LIGHT OF  
SEQUENCE-STRATIGRAPHY .....428**

*Mahmudov R.N., Aghayev Z.B.*

**REGIONAL CLIMATE CHANGES AND  
HYDROMETEOROLOGICAL  
HAZARDS IN ZERBAIJAN.....435**

*Blasi C.J.*

**FACTS, INVESTIGATION AND CONTROL  
OF WATER QUALITY AND PUBLIC HEALTH.....442**

*Khalilov E., Wang L., Khalilova L.*

**GRAVITATIONAL PRECURSORS BEFORE SOME  
MEGA EARTHQUAKES.....454**

*Wang L., Khalilov E.*

**GLOBAL GRAVITATIONAL EFFECTS BEFORE AND  
AFTER STRONG M 8.0 SICHUAN EARTHQUAKE  
ON MAY 12, 2008.....465**

*Kesvan P.C.*

**RESPONSIBILITY OF SCIENCE AND TECHNOLOGY  
FOR ACHIEVING SUSTAINABLE FOOD AND  
NUTRITION SECURITY.....476**

*Khalilov F.E.*

**EARTHQUAKE FORECAST MANAGEMENT  
SYSTEM (EFMS).....487**

*Smiljkovic Z.*

**HEAT TRANSFER ANALYSIS OF LARGE ARCH DAMS  
RESPECTIVE TO ETTRINGITES AND ALKALI SILICA  
SLOW REACTION.....497**

*Nabeel Ahmad, Awais M., Shahid Riaz M., Irfan M. and Qaisar M.*

**EARTHQUAKE FORECASTING BY GRAVITY  
VARIATIONS PRECURSORS RECORDED  
AT ATROPATENA SYSTEM.....516**

*Mammadov P.*

**THE RAPID PLIOCEN-QUATERNERY  
SUBSIDENCE OF SOUTH CASPIAN BASIN  
CAUSED BY SUBDUCTION OF ITS  
CRYSTALLINE BASEMENT.....523**

*Mammadov P.Z., Ganiyeva R.Y., Mammadova P.*

**LATERALLY DEVELOPED SEDIMENTATION OBJECTS  
IN THE SOUTH AND MIDDLE CASPIAN BASIN.....534**

## **HUMANITARIAN SCIENCES**

*Amiraslanov T.*

**AZERBAIJAN KITCHEN.....546**

*Mammadov A.*

**AZERBAIJAN-TURKEY FRIENDSHIP  
AND BROTHERHOOD IS AN EXAMPLE FOR  
WORLDWIDE.....560**

*Khalilova T.Sh.*

**CASPIAN OYCUMEN IN THE WRITTEN  
AND MYTHOLOGICAL TRADITION OF ANCIENT  
WORLD.....567**



*Seyidov A.*

**HELENENDORF: THE GERMAN IMMIGRANTS OF  
AZERBAIJAN.....588**

*Makili-Aliyev K.*

**CASE OF CATALONIA: A RETURN OF THE ISSUE OF  
SELF-DETERMINATION TO THE  
EUROPEAN CONTEXT?.....601**

*Khalilova T.Sh., Khalilov E.N., Renying Li*

**THE GREAT EURASIAN BRIDGE ACROSS THE  
CASPIAN SEA.....618**

*Renying li*

**CHINA'S ONE BELT AND ONE ROAD INITIATIVE AND  
AZERBAIJAN'S TRANSPORT CORRIDOR STRATEGY.....650**

*Samedzade Z.*

**ABOUT AZERBAIJAN MODEL OF DEVELOPMENT  
AND ITS RESULTS.....665**

## **ARCHITECTURE AND CONSTRUCTION**

*Gabibov F.G., Shokbarov Y.M., Gabibova L.F.*

**USING UTILITED METAL-CORD TIRES IN  
GEOTECHNICS.....671**

*Guvalov A.A.*

**REDUCING SHRINKAGE AUTOGENOUS SELF-COMPACTING  
CONCRETE WITH A ZEOLITE-CONTAINING  
MODIFIER.....683**

## **OIL INDUSTRY AND KHEMICAL**

*Gabibov F.G., Kulchitski L.I., Gabibova L.F.*

**ABOUT FINDING THE EFFECT OF STOPPING  
FILTRATION  
IN MONTMORILLONIT CLAY.....689**

## **PREFACE**

### ***60 anniversary of Prof. Dr. Elchin Khalilov***

Volume 4 of the series „Science without borders“ is dedicated to 60th anniversary of the Prof. Dr. Elchin Khalilov, the present the President and Founder of the Azerbaijan Section of International Academy of Sciences - Health & Ecology. Him scientific outputs is so relevant that we have added the him biography to this congratulations. Elchin Khalilov is the “Spiritus Leader” of the foundation of Azrbaijan Section of IAS HE. So he could contribute to a central goal of President of Azerbaijan Heydar Aliyev: To intensify the interlinkage of the universities of Azerbaijan with partners outside of the former Soviet Union.

President of Republic of Azerbaijan, Nationwide Leader of the Azerbaijani People Heydar Aliyev was honored for his support on this endeavor and awarded with the Pavlov Honor Pin in Gold, the highest award of IAS-HE - as well as his follower president of Azerbaijan Ilham Aliyev. So Khalilov could win the rectors of the leading universities, key politicians and key scientists of Azerbaijan to participate in this NGO and think tank. Just one highlight of his activities should be brought in memory: The - I think - first international conference in Azerbaijan dealing with comprehensive aspects of environmental and natural disasters problems. So participants from all over the world came to Baku this this remarkable event in the year 2007. Many other scientific conferences e.g. in Turkey hosted World Forum - International Congress "Natural Cataclysms and Global Problems of the Modern Civilization" (September 19-21, 2011, Istanbul, Turkey). Khalilov linked his scientific work permanently with the initiatives of Azerbaijan Section of ICSD/IAS HE: So he contributed since decades with high effort to the problem of the prediction of earthquakes. His equipment “ATROPATENA” station for the forecasting of earthquakes is now in successful use in different countries.

His initiative was not only the basis for the implementation of ATROPATENA station in Pakistan, but also to the integration of the Academy of Sciences of Pakistan as representative of IAS-HE in Pakistan. His experimental studies to gravitation are cornerstones in the discussion up to now.

Khalilov focused his interest primarily on the transfer of knowledge to health and live safety relevance application: So he developed in the Scientific and Research Institute for the Forecasting and Studying of Earthquakes of Azerbaijan Section of IAS-HE a technology to build earthquake resistant houses. He could demonstrate on our scientific meetings the efficiency of his “dancing walls” up to burdens equivalent to earthquakes of stage 10 of scale MSC-64.

*Presidium of ICSD/IAS HE and all authors of this Volume 4 of series “Science Without Borders“ express you, dear friend Elchin with their contribution the best wishes for the coming decades.*

**General Secretary of ICSD H&E**  
**Prof. Dr. Oleg Glazachev**

**President of ICSD H&E**  
**Prof. Dr. Walter Kofler**

***Addendum: Biography of President Prof. Dr. Elchin Nusrat Khalilov***

## *60th anniversary*



**Elchin Nusrat Khalilov** was born on April 26, 1959 in s. Baku is in the family of a famous scientist - oil geologist, Professor Dr. Nusrat Khalilov.

### **EDUCATION AND ACADEMIC DEGREE**

- Elchin Khalilov graduated from Azerbaijan Institute of Petroleum and Chemistry named after M.Azizbeyov in 1981 on speciality of geophysicist (the master, the engineer-geophysicist).
- In 1984 E. Khalilov defended PhD in geotectonics at the Institute of Geology of National Academy of Sciences of Azerbaijan.
- In 1990 he defended thesis doctor of geological and mineralogical sciences at the Moscow State University after M. V. Lomonosov (c. Moscow) in the area of research and prediction of earthquakes and volcano eruptions.
- In 2011 Elchin Khalilov was assigned the academic title of Professor in the Speciality of geotectonics and geodynamics.

## **WORK AND RESEARCH ACTIVITIES**

- From 1981 to 1989 he worked in the Southern Branch of All-Union Scientific-Research Institute of Geophysics of Ministry of Geology of USSR in positions of: engineer, junior scientific specialist, senior specialist, chief specialist and chief of laboratory of modern geodynamics "Tethys".
- From 1986 to 1989 Khalilov E.N. was elected as the Deputy Chairman of the Council of Young Scientists and Specialists of Azerbaijan.
- From 1988 to 1999 he was elected as the Deputy Chairman of the Union of Inventors of Azerbaijan.
- From 1989 to present he is President of the International Scientific and Technical Complex "Intergeo-Tethys".
- From 1991 to 1995 he was elected as the deputy of Baku State Council of People's deputies, the chairman of permanent deputy commission on ecology.
- From November 1993 to January 2014 Elchin Khalilov was the head of Scientific-Research Center of the Ministry of Defence and directly subordinated to the Minister of Defence of Azerbaijan.
- From 1997 to January 2014 he got the status of the Head of the Main Department of Science of the Ministry of Defence of Azerbaijan and Chairman of the Scientific Military Council of Ministry of Defence of Azerbaijan.
- In 2000, Khalilov E.N was appointed as Vice-Chairman of Expert Council of Higher Certifying Commission at the President of Azerbaijan.
- From 2002 up to present time E. Khalilov is the director of Scientific-research Institute on forecasting and studying of earthquakes (SRIPSE).
- In 2006-2010, Khalilov E.N was appointed as Chairman of Expert Council of Higher Certifying Commission at the President of Azerbaijan.
- In 2006 Elchin Khalilov was appointed a director of the International NATO Project SfP-982167 on the topic "New Technology of Seismic Stable Construction".
- In 2007 Khalilov E.N. was the Co-Chairman of the International Symposium «Natural cataclysm and global problems of a modern civilization» with participation of scientists from 30 countries of the world (on September, 24-27th 2007 г, Baku).
- From 2008 also is director of the ICEP program - International Cooperation for Earthquake Prediction.
- In 2011 Khalilov E.N. was the Chairman of the International Congress - World Forum «Natural cataclysms and global problems of a modern civilization» with participation of scientists from 40 countries of the world (on September, 21-23th 2011г, Turkey, Istanbul).

- Present time (2019) he works as the Director of Scientific-Research Institute of the Forecasting and Studying of Earthquakes (Baku, Azerbaijan), President of the International Scientific and Technical Complex Intergeo-Tethys and Director General of the Scientific-Industrial Mining corporation "AZERZEOLIT".

### **MEMBERSHIP**

- In 2001, Khalilov E.N. was elected as the full member of International Academy of Science/International Council for Scientific Development H&E (Austria, Innsbruck) and president of Azerbaijan Section of International Academy of Science/ICSD H&E (to present time).
- In 2007 Elchin Khalilov was elected as a Vice-President of the International Academy of Science H&E (Austria, Innsbruck).
- In 2008 was elected as an academician of Russian Academy of Natural Science.
- From 2009 Elchin Khalilov elected of the Chairman of Board of World Organization for Scientific Cooperation (WOSCO).
- From 2009 is President of the Global Network for the Forecasting of Earthquakes (Germany, Munich) - [www.seismonet.com](http://www.seismonet.com)
- From 2009 Elchin Khalilov elected of the *Chairman of the International Committee on Global Geological and Environmental Change -"GEOCHANGE" (IC GGEC GEOCHANGE, Germany, [www.geochange-report.org](http://www.geochange-report.org));*
- From 2017 to present Elchin Khalilov elected of the President of World Organization for Scientific Cooperation (WOSCO, [www.wosco.co](http://www.wosco.co), Munich, Germany).
- Elchin Khalilov was elected an academician of the International Academy of Ecology and Life Safety (jointly with the UN) in 2018.

### **EDITORSHIPS**

- GEOCHANGE: Problems of Global Changes of the Geological Environment. ISSN 978-9952-451-08-5 **Chief Editor.** 2010 – to Present.
- Bulletin of the International Academy of Sciences. Russian Section. ISSN 1819-5773 **Member of the Editorial Board.** 2005 – to Present.
- SCIENCE WITHOUT BORDERS. Transactions of the International Academy of Science. ISSN 2070-0334 **Co-Chairman of the Editorial Board.** 2001 – to Present.

## **GENERAL INFORMATION**

- Khalilov Elchin Nusrat is a famous scientist in the sphere of geodynamics, seismology and tectonics. He took part in many international conferences, held in USA, Russia, China, England, Austria, Azerbaijan, Germany, Brazil, Spain, Belgium, Czechia, Indonesia, Pakistan, Turkey, Bulgaria, Saudi Arabia, the United Arab Emirates, Greece, Iran, Kazakhstan, Ukraine, Slovakia and other countries.
- E.N.Khalilov is a co-author of the sole scientific discovery in Azerbaijan, more than eight-ten patents for invention (PCT, EUROPATENT, Eurasian patents, national patents of different countries).
- E.N.Khalilov is the author of more than 300 published scientific articles, eight monographs, more than 300 popular scientific articles. Three monographies of Prof. Elchin Halilov are also in library of the congress of the USA.

## **AWARDS**

- Gold Medal of Prize for Science and Technics of Lenin Comsomol of Azerbaijan (Azerbaijan, 1984);
- Gold Pin of International Academy of Science H&E (Austria, 2001);
- Silver Medal "Author of Scientific Discovery" of Russian Academy of Natural Science (Russia, Moscow, 2003);
- Medal of International Academy of Ecology and Nature Management named after Academician V.S. Altunin (Russia, Moscow, 2007);
- Honorary Medal of Pakistan Academy of Science (Pakistan, Islamabad, 2009).
- Gold Medal of World Organization for Scientific Cooperation "Science Without Borders" (Germany, 2014).

## **INTERNATIONAL SCIENTIFIC ID**

- **ORCID ID: 0000-0001-7952-2802**
- **Scopus ID: 36089816000; 7005456180**
- **Loop profile: 476052**

## **FOREWORD**

The fourth volume of the multidisciplinary book “Science without borders. Transactions of the International Academy of Science, H&E, 2017/2019”, has 55 scientific articles.

In the book are represented the articles of famous scientists from Austria, Azerbaijan, Japan, USA, Russia, China, Brazil, Kazakhstan, Turkey, Pakistan, Colombia, Sweden, Algeria, Ukraine, Romania, Greece, France, India, Germany, Serbia.

This book solves one of the main problems of ICSD/IAS the exchange of scientific information and uniting of efforts of different scientists of the world for solving of the most actual problems of humanity. The book consists of seven parts: multidisciplinary researches, medicine and biology, physical-mathematical sciences, earth sciences and ecology, humanitarian sciences, architecture and construction, oil industry and chemical sciences.

Full members (Academics) and Corresponding Members of IAS from national sections of different countries have published their scientific articles in this book. Besides, there are the articles of scientists, recommended by Academics of IAS H&E.

### ***Editorial Board***



## **MULTIDISCIPLINARY RESEARCHIES**

### **AN ATTEMPT TO INTEGRATE THE RELATIVITY THEORIES INTO A COMPREHENSIVE HEALTH ORIENTED MODEL**

**<sup>1</sup>Kofler W., <sup>2</sup>Khalilov E.**

*<sup>1</sup>International Academy of Science H&E (Innsbruck, Moscow),*

*<sup>2</sup>International Academy of Science H&E, AS (Baku, Azerbaijan),*

*walter.kofler@ias-he.com*

*prof.khalilov@ias-as.org*

#### **Overview About The Problem And The Proposed Solution**

##### **Abstract**

Given and predicted health problems demonstrate: There is an urgent need to extend the power of the scientifically based medical disciplines notwithstanding that the knowledge in medicine redoubles about all five years. But the surplus is concerned just the power of the sectoral disciplines. It is the consequence of the increasing specialization. Therefore another key aspect of medicine is affected: The needed connection between the different related disciplines on a causal level. There is not only now surplus: The problem increases with the increasing specialization. Therefore there is no scientific reason for a change as long as the methodological technique is not adequately adjusted.

The health related scientific disciplines can be arranged according the first occurrence of the related entities and their processes: From physics up to disciplines oriented on sociocultural topic. They all accept an evolutionary process which covers all entities. This implicates that the evolutionary younger entities and their characteristic processes are the autopoietic results of their ancestors. Now the key problem for the incompatibly is obvious: We have no answer why and thanks to what the more ancient entities could be the precursors for in principle new types of followers under the e.g. environmental conditions of the creation of the emergent and its persistence sufficiently.

But the related scientific community neglects these aspects of the nature of the evolutionary precursors. The actual models present the follow up of the occurrence of different entities from Big Bang via cosmological evolution and the occurrence of different particles to matter and up to life. Then the model of Darwin allows to make plausible the differentiation of species up to primates, but not the step from inanimate to the animate. In addition Darwin focuses our interest on an additional heuristic fact to

understand the progress to human persons as social beings. This offers just limited help to understand the interactions between the intellectual, cognitive, social and cultural evolution up to the man made creation of virtual worlds with their positive and negative health effects. The sectoral disciplines are very powerful “within its evolutionary level”. But the causation of the occurrence of their resource object remains open. We know actually only the timetable of and the surroundings for their occurrence. So the immunologist cannot explain why antigens and antibodies can recognize each other and move actively together and interact e.g. with agglutination: This all without sensory organs, a brain and muscles. The position is: There is no need to know it: The do it -as long times mankind accepted that stars do not fall to earth but apples do. Such fundamental agreements are needed. They are not based on natural science but on worldviews. “Worldviews” and their scientific expressions of “paradigms” are matter of philosophy. Natural scientists hate philosophy. But paradigms are finally the indispensable “scientific” argument to stop further discussions to explain obviously correct scientific questions.

We should expect additional benefits for medicine if we would be able to bridge the gap between the first occurrences of the most ancient health related entities and their health related processes. We should not expect to answer the questions of the future just with the scientific and paradigmatic tolls of the past.

We need a new type of paradigmatic model which allows to answer scientifically to the questions which are actually skipped thanks to the social agreement about the implicit paradigms and their “black box - terms”: Such terms, like “autopoiesis” are temporarily helpful, but not permanently sufficient as long as the content of “its box” is not made plausible. The model should cover all the sectoral (explicit or implicit) used paradigms insofar they are health relevant. Then the new model (of the “Extended View”) would like a ground set all the others as subsets with more or less intersecting sets. Such a ground set would allow to shift from one subset to the ground set and from this to other sub sets. The power of the use of the subsets remains without any loss!

The range of health relevant factors reaches from light - e.g. to, produce Vitamin D - and gravitation - indispensable to explain the broken leg - up to behavior based civilization diseases and the hunger in the world thanks to the increase of food prizes thanks to virtual economy. So the model has to cover from Big Bang to Big Mac” and further on to virtual worlds. This model could be the starting point for additional scientific approaches. Einstein used this type of technique to link electromagnetism and mechanic primarily with a new paradigm and secondary their formulas with Relativity Theory. So the door would be open for fundamental progress for many medical disciplines. But the basic steps has to be done before. Kofler published different papers to the basic problematic and the tools for their application (e.g. recently) /1/.

These contributions deal with the a special aspect: Is it possible to integrate the world views behind the relativity theories in such a way, that as well the health relevant aspects of gravitation can be integrated as the self-organized steps to evolutionary younger processes than gravitational ones. Gravitation is relevant for two standard models. The standard model of particles is based on the presence of gravitation. The standard model of cosmology starts with Big Bang and inflation. It covers Dark Energy which is assumed as not influenced by gravitation. So it makes sense to split the content of the integration of these two standard models and their integration into the evolutionary process up to recent times.

There is a third special paper needed: To deal with the applicability of the proposed “Extended View” in the prerequisites for the health effects which occurred just in the youngest evolutionary period.

These three papers can be understood as the backbone for a comprehensive understanding of the health, illness and recreation of a human person as a social being and his expectations on and interactions with his environments. These parts have been matter of lecture series at the Medical University in Innsbruck with the focus on Social Medicine and Public Health and now in the Sechenov University in Moscow for a comprehensive understanding of Physiology as mother of all theoretical disciplines of medicine.

There are basic positions which are relevant for all the three “back-bone-papers”:

➤ Is it possible and if yes in which way to interpret the related paradigms - in this case of the relativity theories - as special cases of a more general worldview which can be used as starting point for an ”Extended View” as ground set for all other disciplines insofar they are relevant for health.

➤ Is this possible under the premises that the actually given applications of the General Relativity theory are not only respected but also not needed for the approach?

➤ Are health relevant applications or new question with health relevance possible?

Three general considerations are brought into discussion:

Block A: The creation of a model to make plausible how actors can create in principle emergent new entities or processes. This process should explain the occurrence of characteristics which have not been before. Therefore the model should make plausible e.g. why, in which why and thanks to what kinds of characteristics or abilities e.g. live could constitute itself just on the basis of inanimate.

Block B.: A technique to avoid simplification and reductionism without inhibition of further specialization. Oversimplifications are recognized as reasons for the unintended creation of gaps between sciences. Therefore an additional hint is claimed: COMPREHENSIVE SIMPLICITY: “*As simple as possible, but not simpler*” (Einstein):

Therefore all must be communicable distinct, what can be thought or observed as different. An additional term has to be introduced if this is not possible.

As a metaphor we use chess again. Chess is based on agreements about the meaning which is attributed jointly to characteristic structured figures. Therefore the whole WINWIN concept is based on the assumption that the players/actors are able to attribute meaning to (observable) structures, make agreements (e.g.) about their meanings and about the (invisible) rules for the allowed movements. Finally they are able to move the figures. Just the movement can be explained with energy. An additional term had to be introduced, characterized and empirically proved according to Comprehensive Simplicity: Discrimination. Details will be presented including a clarification in relation to the falsified “Vis Vitalis”.

Block C: A technique to link former incompatible theories in such a way that the power of the old theories remains and additional power is won. This technique is based on different proposals of Einstein. He developed an epistemological tool to create the so called ”theories of principles”. He applied these techniques successfully to link the former mathematically and logically incompatible theories of mechanics and electromagnetism within the Special Relativity Theory.

The considerations of Einstein will help us to deal with predictions for further applied options.

Proposals are presented to deal adequately with all three prerequisites.

The fundamentals of the Extended View are presented in the addenda and discussed also in the second paper of the two authors in the same volume /2/. It will be shown, that

- there is no need to adjust the proposed model of the Extended View with respect to the special needs of gravitation,
  - the model is proved for general applications
  - including its application to deal with evolutionary surplus thanks to intellectual efficiencies.
- It imitated the (re-) discovery of an ability “to deal with information” (discrimination)
  - This allowed the detection of new types of negative and positive , causally unspecific health effects thanks the effect of sufficient or not sufficient availability of that ability
  - And therefore a fundamental extension of power for curative preventive and promotive offers of medicine and Public Health
- It demonstrated the power of the use of philosophical-theoretical tools as indispensable prerequisite of concrete science applied

- Even scientific terms, symbol, formulas, natural laws etc. are just free inventions of the human mind justified thanks to the more appropriate answers to (scientific) daily life questions.
- Paradigms are not understood as objective knowledge “*what holds the world together in the innermost*” but just as problem oriented tools to handle as economic as it is possible according to science.
- Therefore paradigms for sectoral disciplines are indispensable but do not justify the claim to be the only allowed.
- Then many paradigms can be understood as sub sets within the ground set of the Extended View.
- The answer on the question of determination, arbitrariness or freedom for decisions within the given frames depends on the accepted paradigm.

## **I. Introduction**

### **Alzheimer demonstrates: indispensable theories cannot be linked sufficiently**

Maybe it is surprisingly: But the final cause for the discussion about this paper is the fact that the available theoretical frames for health and medicine are insufficient. This is known since decades, e.g. thanks the classic paper of Engel in Science 1977 /3/. The last disbeliever should be convinced thanks to the decision of Pfizer to skip its own research to Alzheimer and Parkinson /4/. Pfizer is the world largest pharmaceutical company (business volume 2016 52,8 billion US\$) The decision was conclusive: There is no realistic assumption that the invested money can be recovered: The research director pointed out: “ *This decision was driven by science; not cost*”... The currently used scientific views from our world (paradigms) are not adequate for the needed scientific challenge /5/. It is based on the so called cluster methods. This method has to disclaim on any logic based theory but just on statistically significant linkages. This is similar to the hope to guess right 6 from 45. But it is true: The hope persists that a lucky person will find the solution. But the game must go on up to the point of the lucky punch. Pfizer confirmed to contribute to stimulate the further ongoing of that game of luck: “*We have full faith in the broader scientific community that meaningful therapies can and will be discovered in the long-term. That is why Pfizer plans to create a venture fund, with the specific goal of investing in biotech companies conducting promising neuroscience research, particularly in areas of unmet need.*” The other - more scientific way - would be to develop a model which allows to link scientific disciplines which are based as well on natural sciences and as on not natural sciences on a causal level. Such a COMPREHENSIVE model does not exist for the following reason: The different paradigmatic positions and the related terms and tools are not compatible. This is the

consequence of the technique which was and is responsible for the success of the SPECIFIC APPLICATION of the different health related disciplines: Each discipline enforces its activities on a special segment of entities and their processes and skip out other topics. Therefore we need both: Highly specialist disciplines to improve their specific power against the different specified diseases and an extended view which allows to link all and guide them to a comprehensive understanding of very complex processes, dealing with different evolutionary levels. All health related disciplines accept the evolutionary nature of all what exists. This joint position can be used as a fundament to create a paradigmatic position which enables us to integrate the different specialist paradigmatic positions as subsets within the new basic set. This should offer options to adjust the tools which are used within the different sectoral scientific disciplines of evolutionary oldest processes up to the health relevant consequences of the evolutionary youngest processes of our social and cultural and virtual world /6/.

## **II. The Way - Overview**

Three prerequisites have to be handled for such an ongoing:

Block A: The creation of a model to make plausible how actors can create in principle emergent new entities or processes. This process should explain the occurrence of characteristics which have not been before. Therefore the model should make plausible e.g. why, in which why and thanks to what kinds of characteristics or abilities e.g. live could constitute itself just on the basis of inanimate. This question is seen as independent from other interesting questions, e.g. when and where this process has taken place.

It is shown that this is possible: Prerequisite are the agreements about two types of contents. First to agree about the meaning of (or the information attributed to) well definite structures and second agreements about the restricted use of each type of such structures for movements. The combination of these two agreements therefore allows individual variability in the use but only within the frame of the agreements. We are using the game of chess as a showcase later to demonstrate this in detail. This demonstrates the basic evolutionary principle is WINWIN. Both players must share the rules and will distribute it. This is the best way to maximize the personal win. The common known evolutionary principle of biology (selection, mutation, reproduction) is a special case. This is pointed out later. It causes just modifications of the same but not in principle emergent new.

Block B.: A technique to avoid simplification and reductionism without inhibition of further specialization. Oversimplifications are recognized as reasons for the unintended creation of gaps between sciences. Therefore an additional hint is claimed:

COMPREHENSIVE SIMPLICITY: “*As simple as possible, but not simpler*” (Einstein): Therefore all must be communicable distinct, what can be thought or observed as different. An additional term has to be introduced if this is not possible.

As a metaphor we use chess again. Chess is based on agreements about the meaning which is attributed jointly to characteristic structured figures. Therefore the whole WINWIN concept is based on the assumption that the players/actors are able to attribute meaning to (observable) structures, make agreements (e.g.) about their meanings and about the (invisible) rules for the allowed movements. Finally they are able to move the figures. Just the movement can be explained with energy. An additional term had to be introduced, characterized and empirically proved according to Comprehensive Simplicity: Discrimination. Details will be presented including a clarification in relation to the falsified “*Vis Vitalis*”.

Block C: A technique to link former incompatible theories in such a way that the power of the old theories remains and additional power is won. This technique is based on different proposals of Einstein. He developed an epistemological tool to create the so called “theories of principles”. He applied these techniques successfully to link the former mathematically and logically incompatible theories of mechanics and electromagnetism within the Special Relativity Theory.

These three aspects are not part of the “normal” application of epistemic or ontic tools on physics or any other science (Kuhn Th. /7/ They deal with its philosophical abstract fundamentals: Block A) with the scientific worldview (“paradigm”) and therefore with special ontic, the block B) and block C) with epistemic aspects. Einstein summarized these three aspects with “theory”.

The proposals have to be proven - actually just on its applicability on the evolutionary oldest level - gravitation - and the actual daily life. This proving and - possibly needed- adjustment of the philosophical positions to the empirical data and logical conclusions is the key point for the fundamental scientific step: the interlinkage between the philosophical-abstract part of (any) science and its e.g. physical-practical application. Einstein offers relevant tools even for that.

### **III. To A: The Proposal For A Self-Guided Evolutionary Process**

We need a proposal for the autopoietic process from the very early beginning up to now, not only the description of the follow up from Big Bang to the Big Mac. This model must enable us to make plausible not only the modification of the same, as the origin of the different species as descendants form the most basic living cell. We need a model which makes plausible that in principle new characteristics are created from precursors without these characteristics which are then the starting point for a divergent

evolution, e.g. the divergent evolution of different species of living beings. The example would be the self-creation of life from not living precursors.

**a) The plausibility of the principle - demonstrated on CHESS**

We propose an EXTENDED VIEW ON EVOLUTION. We will make plausible the principles beyond with a metaphor: /8/

Recognize the game chess:

1) The rules to play - consents for the inner-relationship: There are endless options for figures and playing fields which can be made from wood or stone. There is no logic reason to deduce just 8 to 8 fields in black and white or why a “horse” can only move two forward and one to the side or one forward and two to the side. But each person which are part of this subset of persons we name “chess-players” accepts voluntarily these agreements and neglect all other theoretically possible options, creates on one hand the subunit “chess-players” without any pressure thanks to a natural law. Each person is acting so because of self-interest. It makes predictable that any chess-player, who touch a “horse” will move his “horse” exactly according to the subunit constituting consents. But nobody can know which correct option of movement a chess player will use. The expert can make prediction just on the basis of “risk” thanks to observations and experiences. But sometimes the father is using a “stupid” option. Maybe he is too tired. Or the father is willing to let the son win with the - evolutionary higher - intention, to motivate the son to “love” to play chess and win for his life a source for pleasure and creativity. Chess demonstrates: The invention of the game caused an emergent win is from a quality which is **in principle different** from the qualities of wood, ivory or stones. The emergent win cannot be characterized just with matter or energy of the used matter. The prerequisite for the win are agreements to use the material just according to them and not in one of the endless other possibilities. The decisions neither for the form of the figures nor for the agreements about the related processes which are attributed to the figures can be logically conclusive deduced from the nature of wood, ivory or stone. The agreements are “free inventions” and unpredictable from the nature of the used energetical structures. But the energetical structure is an indispensable prerequisite for the emergent win. Crucial is the attribution of meaning to structures and the agreement between others to accept (voluntarily) the attributed characteristics. Such a voluntary self-limitation is only logically to expect if the individual win is balancing the limitation /9/. The evolutionary progress is possible just as a WINWIN constellation: No win without teammate! There are two types of win: The win to play and the option to be the winner. Both surplus are relevant that even today so many persons like to play chess. Chess has outlasted the inventors of the game because of the willingness to share the knowledge with foreign persons. This is a clever



way to have many different partners to play this game. WINWIN is an additional option to the proposals of Darwin and Wallace to explain the autopoiesis of different types of species. And WINWIN allows making also plausible the self-creation of not living entities and their relevance as precursors for living beings. The rules for outside observers accepting the rules of Chess (consents about outside relations):

2.) But there are not only an agreements how to play chess. There are also agreements between all chess -players to respect the prerequisites that others can play Chess undisturbed according to the rules: Outside observers have to be quite, to keep the adequate distance from the players, but influence the game thanks to their presence. Therefore any player is playing according to the rules. Any cheating would be obvious because of all know all the rules. It is possible to act according to the rules. But this would cause the exclusion from the society of Chess-players.

3.) To accept non-ideality - with influence on evolution

We have to expect situation in which players are interested to increase their chances thanks to cheating. This is based on the priority of the individual surplus and the fact that our world is not ideal.

The acceptance of a not ideal world has consequences, e.g. to expect that nothing can be ideal and that small deviations are inevitable. Therefore there is a need to deal appropriate with them. Therefore we have to expect a range in between deviations can be observed but are valuated as correct. The range of acceptance of such deviation within the accepted range of correctness opens a door for modifications. This can cause the creation of emergent new without contradiction with the agreements of the ancestors. (“evolution vs. revolution”)

Such a position must be excluded in a paradigm which is based on divine natural laws or any other deterministic position: As this would result in each process needing to be ideal. But the consequence of a paradigm which is based on a not ideal world - and therefore on “restricted autonomous actors” with freedom within given frames - is not only that inaccuracy has to be expected. The difference should be expressed on processes in the real word if mathematics is applied. Even the determinist Einstein has to respect the lack on ideality. He came to the conclusion: *“As far as the laws of mathematics refer to reality, they are not certain; and as far as they are certain, they do not refer to reality.”*

4) Evolution - an unintended consequence of intended actions and omission.

You play Chess because of you like to play. Therefore you motivate others to play with you. This mindset is the prerequisite that chess is played now worldwide: This is the unintended effect of individual intentions. A game which nobody likes will not be spread out: Because of the unconscious and unintended neglect to take care for its dissemination.

We are the first generation which has recognized that such effects have to take place. Therefore we are responsible to endeavor to influence the process in direction of comprehensive sustainability.

5) What we cannot know, need not know and what the others do not (should not) know.

You can stimulate others to act according to your intention if you know their intentions and the fact that the unintended side effect of the realization of this intention is your intention. Then you can stimulate the others to realize their intentions and automatically they realize your wish: *“They do not know why they are acting now so.”*

There is no need that you know why they are interested in the realization. It is sufficient, that you can predict the side effect.

There is no need that they know why you have stimulated them to act or to stop an action: *“They do not know what they are acting.”* The intended effect will also take place if they are misinformed, e.g. that the action is in their interest. The movie “Matrix” demonstrated impressively the power of such a strategy. But there is another option: Both have the same intention but accept that the intention can only be reached in cooperation. But the question occurs how to distribute the win after the goal is reached. Or maybe you can win at the expense of your partner. This demonstrates the famous prisoner’s dilemma: If both accuse each other both get a hard sentence but not as hard if one stays quiet and the other accuses. The more and more complex evolutionary process from Big Bang up to today can be made plausible thanks to the use of these types of information based processes.

6) Evolution: a special case of and key to daily life processes

Therefore it is obvious: Many aspects have to take place jointly for the emergence and persistence of a modification of the initial situation. These aspects are part of the common processes between the common actors which are possible precursors. *“To see what everybody can see but to recognize what nobody has recognized before”*, can be but need not to be the prerequisite evolutionary progresses. Such modifications can take place also nearly unnoticed. Nevertheless the evolutionary process can be used as special powerful instrument to understand the interactions and principles of daily life processes: Every process must have taken place the first time and under special conditions. Otherwise they would not have the chance to persist.

Evolutionary modifications can take place unnoticed. They can influence our daily life without the occurrence of new species or new solutions. Feedback systems are such progresses to deal more comfortable with repeated demands.

7). The ancient applicabilities and options for other modifications remain

We should not overlook: The use of wood for chess figures does not change the nature of wood, e.g. to be burnable. The form of a figure doesn't dictate its use as it could also be used e.g. as a decoration in or as a logo for a publishing house.

The persistence of the basic nature and of former given alternative option of the evolutionary precursors (and pre-precursors) is typical for the evolutionary based entities. Therefore you will find also ancient characteristics if you analyze the phenomena e.g. of a disease of a human person. Such findings can stimulate the assumption that just this ancient process is the provoking causation of the health effect. But often the observed was only one element within a long cascade of cause-effect-follow ups. The critical cause can be e.g. an inadequate behavior or value system, but the observed effect can be a shortening or extension of the length of the telomere of the chromosomes /10/. Nobel Laureate Blackburn has presented recently relevant publications to this topic. /11/ The example of CHESS made it clear, that the individual win was the reason to accept the restricting generalized consents. These consents are often the prerequisite for the realization e.g. of health relevant processes. The individual win, which is enabled thanks to the joint agreements are often outside of our interests - as the respect to the demands on resources to realize the self-oriented intentions in the more or less ancient prerequisites for the recent activities e.g. of a person.

**b) Generalization, applicability and its restrictions**

**b) Transfer from the metaphor of a toy to the general evolutionary principle of WINWIN Generalization, Applicability and its borders**

CHESS is a toy. But it makes conclusive that those actors can cause fundamentally emergent processes which are able to have the choice between different options and have the ability to anticipate the effects of their action. These efforts are not to explain sufficiently thanks to physical energy. Therefore there is a good reason to distinguish between these different causations. The power of specialized disciplines is based on better distinction of aspects which were handled before undifferentiated. Therefore we would accept a loss of potential additional scientific power for medicine without the adept to distinct in a scientific way between these effects. Block B will point out that the comprehensive simplicity urges us to introduce a term for the related causation. Otherwise we would support the creation of gaps between scientific fields. So these are reasons to make a foreshadow to block B. We avoid the impression also that the proposed example of chess has no power because of the fact that chess is an invention of humans. Some persons could belief that such creative efforts - as the attribution of meaning to structure and of predictable movements to it - would be restricted to very high living beings like mammals. Maybe they attribute only to humans thanks to their cortex the ability to agree about informative aspects of special movement

and to be able to integrate anticipative expected behaviors into a strategic ongoing with others. But this would be wrong.

### **1) Microbes show anticipation**

Actors with these prerequisites e.g. for anticipation are known even from microbiology. Microbiologists publish phenomena which have to be based implicit on a comprehensive potential even for anticipation -but just on a very basic evolutionary level: So the German Research Society pointed out that simple soil microbes of the species *Myxococcus Xanthus* cooperate in hunting other microbes *“like a pride of wolves”* /12/.

### **2) Fulguration**

This type of emergence can takes place within a short time. It is based on the creation of ideas. This process is quite common and part of daily life: e.g. to “catch” a connection between aspects. Such a situation in science would be named “fulguration” according to Nobel Laureate Konrad Lorenz. The term “fulguration” is deviated from the Latin term for flash. It needs just a moment that former distinct assumed aspects are “flowing together” to a connected conclusion. The “Heureka”- situation of Archimedes is a well-known example: He recognized the connection of volume and weight as specific weight thanks to his observation that the water flowed out from the filled bath tube when he went into the tube. He was so happy in this situation and focused on the success that he was running out without any clothes and called all the time: Heureka - I got it”! Therefore evolutionary progresses from the type WINWIN are just special cases. But it is essential also for them that the recognition takes place immediately. Therefore the transfer into a widespread evolutionary progress can occur relatively quickly - especially in comparison to the long term periods which are needed for genetic based modifications. But it is not topic of this paper to point out the easy to explain linkages between the WINWIN concept and its modification in form of genetically based evolution.

But it is relevant to focus on the following: “Anticipation”, “intention”, any attribution of meaning to structure, but also the simple guidance e.g. of movement are from another quality as movement. Therefore it would not be sufficient to deal with them just on the basis of energy - the physical principle for movement. This is discussed later.

### **3. The dominance of the constructed consent over the specific realized structure**

The example “Heureka” point up, that the special material-energetical situation is losing its relevance, if the connection of meaning to structure is constructed. There is no need to recommend students to jump into a well-stocked bath tube to catch the nature of specific weight. A good teacher can explain the connections easily with words. Maybe the first chess figures have been made really from ivory and ebony. But similar sized figures of any wood painted fulfill the same function. But the material structure is irrelevant finally: Some play with identical sized disc with the symbols on it which we know from the newspapers. Crucial is the consent about the information. The material structure is overestimated - maybe even in the understanding of hormones.

#### **4. Predictable - not predictable**

We can generalize the principle of agreements between chess players: There are subset - constituting consents which can be observed (realized material structures) and such ones which can be deduced from the processes (constructions about processes). The applications of these consents can be predicted.

The individual win cannot be predicted. This aspect is the reason to accept the limitations voluntarily. This part of the process can be observed but it is uncertain.

#### **5. Generalization for other processes: The dancing couple.**

##### *The self-creation of more complex entities*

Agreements can be made not only for the use of tools. Persons can agree e.g. about the follow up of steps: Remember dancing! Then the individual person has to respect special agreements to reach the intended surplus. “Dancing” is a helpful metaphor for the jump from the creation of agreements about the use of tools to the consent between entities which are seen from the outside observer as a unit. You can attribute that e.g. one very basic physical entity accepts to play the role of a magnetic field and another to play the role of an electric field. The outside observer will have the impression of one entity with clearly predictable processes and a crossing point we call quantum. The metaphor “dancing couple” teaches us same more:

##### *Again a Linkage to Block B*

We all know the interrelationship between the electric field and the magnetic field from high school. We learned from Newton that any change in the direction of a movement needs the interaction with an additional force. But there are no additional forces which allow to explain the characteristic movements according to the frequency of a special electromagnetic fields. The phenomenon is really similar to a dancing couple. But we know: Each dancer is stimulating himself or herself according to the rules of the type of the dance. We can invent a position and attribute similar to the electric and magnetic fields within the couple of each electromagnetic field. But the

prerequisite for that would be: To go same steps back in the direction to the Big Bang from the evolutionary level of our Myxococcus Xanthus with its ability to cooperate without guidance. A strange idea! But the acceptance even on that level would bring a positive conclusion for the requirement to propose one comprehensive evolutionary process “from Big Bang to Bog Mac”: If electromagnetic fields would be caused on such an ability then there would not be a need to integrate this ability into the model later.

Without the need to answer: from anywhere? thanks to any what? Anyway: Any scientific theory is just a free invention of the human mind - justified thanks to the increasing power for applications in daily (scientific) life. But the inventions have to fit to the reproducible phenomena - as the need to explain the changings of the directions of frequencies. This phenomenon claims also further argumentation in block B.

*Different consents - within and with others outside*

It is relevant to distinct between two consequences:

- Consequences for inside relations - as of the chess-players or two persons dancing actually waltz together
- and the consequences for the outside relations - e.g. the demands which are resulting for all couples dancing at the same time on the same floor waltz.

Than all actors - dancers are in the same situation: a) To respect - the demands of the other couples /actors - with as less self-limitation as possible and b) to fulfill at the same time the more complex rules for the inner-relationship - in the hope to reach the individual goals which are possible thanks to dancing, to play chess or to act according to any other subset constituting consent. The subset constituting outside oriented consent explain that the actors will respect the distance to the other chess-player/other dancers/entities. A transfer of this principle to processes of particles would make plausible that B. Russell deduced from the paradigm of Einstein that “*no two particle will ever contact the other. Both turn out if they come to close to the other*” /13/ Activities of scientist can cause implicit such interactions in basic quantum physical studies thanks to the effect that the tools of the study design are on the same or similar level as the objects of research and interact with them. Medical scientists are not so often in a similar situation: Their analytical tools are usually so far away from the biological interactions of the research objects that they do not influence the results of the biological processes. No empirical experiment which can be made from or with wood, stone and/or ivory - could come to the logic need of the structure or processes of chess figures. But the empirical proving of the emergent new can falsify logically the theory including the paradigmatic positions which are proposed to make the occurrence plausible of the emergent just from

its ancestors. Therefore theoretical physicists have to integrate these two aspects - the invention of principles and the fact that their usefulness can be proved just retrospective. This is of special relevance if they claim to be responsible to create a comprehensive paradigm which should be valid for all natural phenomena. Einstein has expressed this with the sentence: /14/ *The world view of the theoretical physics “ .. claims to be valid for any natural phenomenon whatsoever...including life, by means of pure deduction, if that process of deduction were not far beyond the capacity of the human intellect. The physicist’s renunciation of completeness for his cosmos is therefore not matter of fundamental physics. The supreme task of the physicist is to arrive at those universal elementary laws from which the cosmos can be built up by pure deduction. There is no logical path to these laws; only intuition, resting on sympathetic understanding of experience, can reach them.*

### **c) Possible restrictions**

The applicability of this proposal does not need additional arguments for processes on the evolutionary level of persons and high animals. Physicists and chemists may see this different. Arguments will be presented later in this paper for the helpfulness of the proposed paradigmatic invention. Now only two arguments: Inventions are proposals for a more appropriate dealing with reality. Paradigms cannot claim to explain “*what the world fits together*”.

- Any proposal to attribute any type of ability to entities is not more than an invention with the intention to deal more appropriate with daily life including thanks to science. We propose the invention to be able to make agreements and to act according to them. This invention is on the same type as the invention that entities are able to use energy for movement within the frame of natural laws.

- The possibility and the effectiveness of agreements is part of everyone daily life experiences. Anyone who accepts that there is only one evolutionary process has to accept that also this fact must be the output of this process. The simplest answer is about its first occurrence: The potential for this is given in any entity but just on the expression with respect of the reached evolutionary level. Any other proposal would be incompatible with the postulate that there is just one evolutionary process.

- Maybe these arguments are conclusive and you are willing to rethink the usefulness of such an ability. But goodwill is not sufficient in science. Therefore the next block deals with additional arguments, empirical proving and exclusion of confirmed incompatibilities of positions which were used to deal with similar processes. It is to demonstrate that the introduction is not a new name for the correctly falsified Vis Vitalis.

#### **IV. TO B: Comprehensive Simplicity – Symmetry**

##### **a) The background**

The loss of the link between the different disciplines which are dealing with the different aspects of the same (e.g. within physics) was the unintended effect of the intention to focus on the power of special logic conclusions about the nature of the selected research objects. This negative output is not a surprise if you accept not only the principle of conservation - primarily discovered in physics - , but also the principle of inhibition and enforcement - primarily discovered by Sechenov and Pavlov in physiology.

##### 1. Validity und connection of general principles of conservation and of inhibition/enforcement

Then it is conclusive: Both principles are linked: Any focus on one aspect must have the consequence of the inhibition of other aspects in a not ideal world. Both principles cause different forms of symmetry. The influence of the relationship between them and their relevance is expressed in different scientific terms, e.g. (the generalized use of) complementarity (Bohr), homeostasis (Claud Bernard 1860, Cannon 1929, von Bertalanffy 1932), yin- yang (Chinese philosophy) or the daily life experience of the relevance of balanced situations. Evolutionary progress is often expressed as “break of symmetry“. Therefore it is helpful to think over about a dynamic which allows to shift from one “balanced situation” to another without a loss of stability. Maturana and Varela propose the term “hemodynamics” which is used also e.g. in social systems (e.g. Niklas Luhmann).

Similar principles but without any linkage! We need a tool to minimize the unintended but otherwise to expect negative effects of the overestimation of selected aspects in science. We propose to use the (epistemological) technique of the comprehensive simplicity.

##### 2. Consequences for the communication between scientific disciplines

But the conservation principle and the principle of inhibition/enforcement stay unlinked side by side in science. But they influence each another in any case also in the way of communication between scientists: We have to expect that we have overweight to content of a term in a special case and neglect others at the same time. This is linked with our daily experience that we integrate into our understanding of terms aspects which are not expressed verbally. Take the example that anybody says: “Peter will come today.” Then different persons can carry the same name. But everybody will think on a special peter, which he knows personally. Therefore each person will assume the special aspects which are relevant for “his” Peter but - maybe - not for other “Peters”. This can



cause incompatibilities in the predictions if it is not taken in consideration that the identical term “Peter” can be attributed to different persons. Einstein used this experience that even scientific terms are focused on the special needs e.g. for movement which are relevant for mechanics and can neglect aspects which are not relevant for that processes. But the neglected aspects can be relevant for the understanding of similar processes which are based e.g. for the movement of electromagnetic fields. The consequence is that the term “movement” covers more than that what this term covers as well according to mechanics as according to electromagnetism. Therefore we need a tool inhibit artificial incompatibilities based in the use of ambiguous terms.

It is recommended to use the (epistemological) technic of the Comprehensive Simplicity.

#### **b) The tool: Comprehensive Simplicity**

Einstein recommends: *“Make all so simple as possible but not simpler”*.

**Therefore we urge the scientist to focus on the need to be able to communicate distinct all what can be observed or can be thought as different. If there is not an adequate term available than such a term must be introduced.**

It is senseless to introduce a term to deal better with our world if not a characteristic is postulated which is attributed to that for what the new term should represent in the real world. These characteristics should allow to prove the helpfulness of the introduced term. It is not sufficient to introduce e.g. only the term “ability to see” to explain the fact that we can observe with our eyes. Such a term would be meaningless. It would not allow additional applications.

Therefore we accept only such new terms in natural science which can be enforced with empirical proving.

#### **1) Different risks for inadequate introductions**

Additional terms should be selected with respect to the evolutionary process. Otherwise they can cause incorrect solutions because of simplification: So it would be not adequate to attribute the term “thinking” e.g. to alga or microbes. Their use of discrimination takes place on a much more fundamental level as the intellectual activities of human. Therefore such an attribution would need a differentiation in consequence of the “Comprehensive Simplicity”. We have to avoid also reductionism. We have to accept that evolutionary younger processes are based on evolutionary older processes. So live cannot take place without oxidation. But life cannot be identified with oxidation - as the teacher of Victor Frankel pointed out: Therefore Frankl asked the biology teacher: *“And where is the sense of live coming from?”* Simplification and reductionism cause easily so called “ecological fallacies”.

## 2) Consequences of implicit and explicit used paradigms

The scientific community of each discipline has the right to definite the range of its research are. All modern natural scientific disciplines accept the only one evolutionary process. Therefore they accept that the entities and related processes of their interest are followers of emergent processes of more ancient precursors. These entities are matter of other scientific disciplines. But there seems to be an agreement between the different scientific disciplines not to ask, in which way the precursors have been able to cause their followers on the younger evolutionary level. So the biologist does not ask thanks to what abilities and interactions inanimate precursors could cause basic live. But also the different types of chemists and physicists do not ask this question.

So all accept that in principle all these steps should be to handle with science but the gaps are not bridged. In which way scientists handle the fact to deal just with a segment within specific entities, their observable processes and the agreement that any effect must be based on a cause. The scientific communities bridge the gaps with the help of their implicit or explicit paradigms. These agreements allow to finish further questions about the causation. The interactions between antigens and antibody are used as example. Both types of organic structures are - from the evolutionary point of view - quite young entities. They are the prerequisites that health relevant processes can occur and also disappear. So the allergy against e.g. birch polls can emerge after a period with neutral contact with these chemicals. The symptoms can increase in their relevance over the years. If you are lucky then they disappear spontaneously. But it can shift to a cross-allergy if you are unlucky.

There are different prerequisite for an AG-AB reactions which have to accept implicit in consequence of the phenomena: AG and AB must be able to recognize each another and to distinct them from others. They must be able to move goal oriented and to interact with another e.g. for an agglutination. But there must be a sufficient causation for the possibility to change the meaning of the structure of the antigen. And all this without sense organs, brain and nervous system, but also without any muscle or flagella! Not to ask these questions seems to be an agreement within the scientific community of immunologists. It seems so that “AG and AB” are able to do this. So the implicit model of immunology presumes nearly the same abilities for AG and AB which are to attribute to energetic and electromagnetic fields within the Extended View.

## 3. Unconscious used paradigm could understood as causation of a dominance of philosophy over real science

This is justified thanks to the paradigm of immunology. But this confirms that the strongest and final argument is based on “philosophy” and causes maybe the greatest reductionism which is possible in relation to the evolutionary process.

But we have to accept borders which allow to stop any additional question for further argumentation within a scientific discipline. This is a consequence of principle of inhibition/enforcement. This seems logically conclusive if we modify our understanding of paradigms.

#### 4. Paradigms only problem oriented tools for science?

Thomas Kuhn has changed the understanding of paradigms in principle: He pointed out that paradigms have changed and will change. No paradigm can claim to be final. Paradigms allow to extend they stay of knowledge on the basis of “normal science”. So we all accept: Paradigms are helpful tools to apply science.

It is proposed to use paradigms just as tools for applications. Then it would be allowed to use just this paradigm which allows to hand a given problem sufficiently correct and as economic as possible. Then it would be sufficient to use the paradigm the earth would be a plate - if your problem is to prove the correct construction of a wall. Then you can use a water scale. It based on the assumption of lines parallel to the surface. There are no parallel lines. But there is no need to respect this. Other if you problem would be to find the shortest way from New York to Frankfurt.

Maybe philosophers would not agree with such an ongoing. But for medicine it seems to be adequate. And the incompatibility with the implicit consequences of the paradigm of the immunologists would disappear - from the demand of the immunologists. Then they accept the most basic abilities even for the nature of the molecules of their interest and let open the description of the follow up from the most basic actors up the borderline of “their” research field.

#### 5) The ambivalent use of the term “energy”

There is no scientific term to communicate distinct about effects of the potential of a person which cannot be handled sufficiently with energy - according to the classic physical definition. It is a pity that the term “energy” is often used for processes, without the wish to inform another about the change in the position of a structured entity within the space - e.g. within an Euclid grid. Many persons speak if mental, intellectual, emotional etc. energy. It is obvious: The content of the meaning of these “energies” is different to the meaning of the physical term “energy”. But the correct use of the term “energy” should be restricted on the content which is attributed by physics. The incorrect use of the term “energy” inhibits not only the distinction between physical and outer physical effects. It suppresses the critical discussion about the term, which would be needed in equivalence to the term “energy” for not physical processes.

#### c) **The application: Postulation of Discrimination Ability**

There is no term to express distinct effects which are not caused by energy (in the content of physical characteristics). Quite common is the use of the term “energy”- e.g.

as “mental energy” - in communication without the intention to inform that this process is based on a physical effect, e.g. the change of positions of matter within an e.g. Euclid analogue grid.

Therefore we have to introduce a term which allows to communicate distinctly with in principle different effect according to the Comprehensive Simplicity. Then we had to propose characteristics and to prove them empirically. All this was done sufficiently. The argumentation was controlled by Nobel Laureate Y. Tse Lee and awarded with the Th. Kuhn Award Hope for the future for a Sustainable World /15/.

1) A short demonstration of the usefulness of the postulation:

Recognize a person which is moving a picture from one side to the opposite one in a room /15/. The related shift in the position within an Euclid grid can be sufficiently explained with the use of energy and the special quality of the structures of muscles. Then look on the picture: The identical matter can be interpreted as well as the face of an old lady, the face of a young girl and of the old father. Usually all young men see the young girl but only few the old lady. Not a surprise: You prefer to see what you like. I can teach them with explanations to recognize also the old lady. I can add colors temporarily to the picture to help them to recognize also the old man. So I can teach the audience and the persons are able to learn. Neither these processes nor the affected surplus can be explained with physical energy.

Therefore we have to introduce a new term - if we accept the principle of the Comprehensive Simplicity. Let us name the term “discrimination”.

The usefulness must be empirically proved. We need adequate characteristics for that what should be represented with this term in reality. I have demonstrated such criteria:

- The available capacity of this ability is restricted: Therefore you can recognize just one face at the same time.
- Personal experiences and wishes influence this process;
- Persons can be motivated to change the actual view and not to persist in the actually given situation
- persons are intending to be in consent;
- environmental aspects can influence the attribution and the available ability to attribute meaning to matter is restricted.

2) Empirical proving

All aspects are relevant but I used just one for empirical proving: The restricted available capacity to attribute meaning to matter. The prediction was: If the introduced term is helpful, then health effects have to be caused in a situation when a high additional demand on the ability is needed. Such a situation was caused after the atom bombs on

Hiroshima and Nagasaki. I used the mortality rate of types of survivors of Hiroshima and Nagasaki. Survivors are persons which survive five years. The stay of knowledge is that survivors are part of the normal population - without the unchangeable effects of the basic incident: A person who lost a leg is after five years in all aspects part of the normal population without his losing leg. The survivors of Hiroshima and Nagasaki are relevant to test the time period between the occurrences of the different types of cancer thanks to radiation.

One group covered only persons without any bodily injury in consequence of the disaster, the other group only persons with two or more bodily injuries. The causation of bodily injuries thanks to radioactivity was standardized thanks to calculation on the basis of identical load in radioactivity (Gray) of the groups. The mortality risk of survivors should be higher in the case of victims with more than two bodily injuries than in victims without bodily injuries: The survivor with bodily injuries had an additional demand on discrimination ability to adjust the bodily deficits and not only the consequences of radiation. This difference should be to observe even after standardization to the same load of radioactivity (standardized to Gray). The prediction could be confirmed.

Other authors explained the differences in the mortality distribution with the assumption that the survivor would be special resistant against radioactivity. This would be in contradiction with the stay of knowledge of the latency period for the different cancers. But they are confirmed in many other studies. Further on the differences in the mortality risk of the survivors correlated also to the predictions about the influence of other aspects which cause e.g. age specific additional demand on discrimination ability.

The most relevant argument was the predictability of similar phenomena in many different environmental and manmade disasters, e.g. in Chernobyl, Bhopal, London smog etc. /16/

The consequences of a restricted availability of resources are well-known reasons for negative health effects since ancient times. But just energetical deficits were taken in consideration up to now, e.g. consequences of hunger, thirst, trace elements etc. up to now. But the research is uncommon for the reasons for a lack on additivity despite of sufficient available energetical resources. Now this gap could be closed with these “causally unspecific health effects”.

But we have to expect also wished health effects thanks to “causally unspecific health effects”. A common know example it the positive effect of a more effective use of this ability e.g. thanks to the use of feedback mechanism /17/. Another example would be the consequence of more available oxygen thanks to training with exposure to higher and lower oxygen load. This principle allowed the prognosis that not only bodily

efficiency can be increased thanks to such training. Also the efficiency to remember could be increased in Alzheimer patients - as predicted /18/.

So the introduction of discrimination opens a wide up to new nearly unused area for a better understanding of curative, preventive and promotive approaches.

3) General consequences

*i. The evolutionary nature of discrimination*

It is helpful to introduce such a term to deal more appropriate with daily life. This ability must be modified within the evolutionary process. I called the most basic one “discrimination” (in equivalence to “energy”). The level of physical and chemical processes can be handled sufficiently with this “discrimination ability”. The processes in living entities needs also the modification to “ability to organize”, for sense oriented entities “ability for emotions” and for intellectual and cognitive processes “ability for critics” (with respect to I. Kant). (e.g. Kofler 2005 /19/

*ii. The abilities for discrimination and to use energy: Expressions of just ONE potential*

The example of the young man moving the picture demonstrates the linkage between the ability to modify the position of matter as well within space as within a grid of meaning: The application of energy cannot explain the direction and the speed of physical movement just the change in the distance: The same amount of energy could be used for the transport of the matter to any new position with the same distance. Therefore it makes sense to attribute the newly introduced ability to any type of guided movement: Therefore no guided movement without direction. But also no change of information without the related matter!

Therefore we propose that both abilities are just two different versions to use the same potential. This term is loaned from the Aristotelian term “potentia”. We repeat now that what Heisenberg has done consciously. He expressed this position clearly /20/. He used his position in the Copenhagen Convention in a formulation which covered as well his position as the position of N. Bohr. - But his position had only few followers.

*iii. Evolutionary substance dualism*

The “carrier” of potentia is just ONE substance - a common term in philosophy and different to the content of the term “substance” in daily life. Therefore there is no need for a Cartesian position with two different substances as “carrier” of the different types of effects. Therefore there is no need for the - falsified - Vis Vitalis or similar substance dualistic or substance pluralistic positions.

A substance monistic evolution based position seems to be sufficient.

*iv. Two interlinked grids: one for space - the other for meaning, interlinked with “time”*

The two different effects cause two types of grids to deal with possible effects of modifications: A grid for the position of entities and a grid of meaning. This opens interesting aspects for our understanding of time. It does not make any sense to attribute to meaning or information geometrical coordinates like height, length or broadness. But “time” is relevant for both grids. Time is needed as well to express changing in the position of matter as to meaning which is attributed to matter or to construct-constructions /21/ like ideas. Therefore the integration of time links consciously or unconsciously both types of grids - and their interlinkage.

There is a need to distinct between the individual and generalized position in space and the (individual) meaning and the (generalized) informative relationship.

The distinction between the individual special situation and the generalized geometrical position is needed to be able to communicate distinct on the individual level and generalized. The individual relation to another object can be described as follows: The cup is before, behind, on the side etc. of the apple. There is a need for an agreement about the characteristics of an abstract grid to characterize a position in geometrical relationship. (Again consent!): A typical case is the geometry of Euclid. If you use this than you can characterize the position of an object in centimeter - or in inches etc. The Euclid geometry is an invention of the mankind. You can assume that ancient entities created their own agreements about relativity: Then you can understand the formulas of transformation as our hints to deal with them as adequate as possible.

Similar is the relation between meaning and information and the need for an abstract structure to deal with their relationality. “Meaning” is needed to express the individual attribution to a structure or a construction (like an idea, a word etc.). There is a need for a consent of the individual meanings to the same structure or construction for communication. Every sign can have your individual meaning. You can create your personal secret alphabet. But you must skip the liberty to attribute your personal meaning and accept in agreement the information which is linked with the letters. The diversity of letters demonstrates the arbitrariness. Therefore the hieroglyphs have been interpreted as paintings before the stone of rosette was found with the same text of three languages.

So the terms movement and information correspond to each other: Movement as the process with the effect of a modification of an entity in e geometrical grid, information as the result of the modification / attributing of meaning to a structure within a grid of meaning.

*v. Two relations: relativity and relationality*

It makes sense to distinct with two terms for the relations and their modifications. Einstein introduced the term “relativity” to express the relations within geometrical grids

including their transformations within different systems which can be characterized with physical terms.

But it would be in contradiction to the comprehensive simplicity to use the same term for relations within systems which cannot be handled sufficiently just with physical terms. Therefore the term “relationality” is proposed. Einstein presented an impressive example for that: *“I am called a German man of science today in Germany, and in England I am represented as a Swiss Jew. If I come to be represented as a bête noire, the descriptions will be reversed, and I shall become a Swiss Jew for the Germans and a German man of science for the English!”*

4) Possible incompatibilities e.g. with Einstein’s ontologic positions

Einstein is using a position in the GRT which can be understood as a Cartesian dualistic position from the philosophical point of view: He illustrated the - accepted beyond any dispute - powerful formulas of the General Relativity Theory with the proposal, we should assume an universe in which the geometrical formulas structure the innermost of the universe in such a way that this new type of ether interacts with physical existing entities. Abstract geometrical formulas and physically existing entities are obviously from different types of nature. The interaction between the geometrical - mathematical nature of the “space-timed” universe and the energetical characterized physical entities is an interaction between two in principle different causations. Philosophers agree usually that in principle different natures cannot interact. The linkage would demonstrate the similarity of them. Descartes handled this problem with the omnipotence of God: God is linking the two incompatibilities substances of *res extensa* and *res cogitans* in the pineal gland of humans only. But some philosophers e.g. Popper accepted a substance dualistic position.

But every term and with them formulated theory is just a free invention of the human brain - as Einstein has pointed out. He has proposed this position years before this position was introduced as basis for linguistic by Ferdinand de Saussure /23/. Therefore the position that terms are free inventions is generally accepted: Theories are only helpful within the power of the used terms to deal with reality, *Wirklichkeit* and virtuality. The consequences of this position need to be discussed in the next chapter.

**V Albert Einstein - Philosopher – Scientist /24/**

This is the title of Volume VII of the Library of Living Philosophers, edited by P.A. Schilpp. The invitation to present the ideas within this serious was accepted as the highest reputation within the community of philosopher - as the Nobel Prize in science. Einstein is the only (natural) scientist who is awarded in such way. His unique position is seen e.g. in his contribution to link the philosophical abstract aspects - which are the basic for any science consciously or unconsciously - with the natural scientific/ e.g. physical practical aspects. Einstein could link heuristic aspects, e.g. the paradigmatic



principles of equivalence and simplicity with the creation of epistemological tools. This allowed him to transfer them for application /25/.

**a) Terms, symbols, formulas, natural laws: Free inventions of the human mind**

He deduced conclusively that any word including any scientific term is a free invention of the human mind. It stays for anything, which s from another nature than the nature of terms. Any term deals just with selected aspects of that for what it is staying. Therefore a term “makes a long story short”. Therefore e.g. the natural laws - which are formulated with words and mathematical symbols / numbers - are also “*free inventions of the human mind*” /26/. The justification of such inventions is based on the additional power to deal more appropriate with daily life including the scientific work. No theory can reclaim to express the reality “beyond” it. Therefore “*any (physical) theory has to respect the difference between the objective reality and the (physical) terms, which are used in the theory*” which helps us to “*an imagination of the reality*” /27/.

**1) The theory defines what can be observed, what not and in which way we have to interpret the phenomena**

Einstein deduced from the invented and therefore restricted theories that “*the theory defines what can be observed*” /28/. Heisenberg extended this position: “... *and that what cannot be observed*”. We can extend this again: “... and in what way we have to interpret the phenomena.”

This should be explained with a thought experiment. It is modified to the example which Russell presented to explain the paradigmatic position of Einstein in opposite to the position of Newton /30/.

*The tiger in the park /31/*

Assume daemons which are only able to observe such aspects of the reality which are based on the scientific tools of his scientific field and the related education. Then a physicist would only be able to observe physical aspects, a biologist also biological aspects, a psychologist also psychological aspects and e.g. a psychiatrist also mental disorders. All observe the same process: In the center a big mass T and around smaller masses  $m_1$  to  $m_6$ . Then a sound occurred. Then the six masses move away from mass T: The physicist has to explain this with a repulsing power from mass T. Masses  $m_1$  -  $m_6$  are moved passively.

The behavior science based biologist can distinct also living entities. Therefore he recognizes that the mass T is a tiger in a cage and the masse  $m_1$  to  $m_6$  are human persons. The sound is caused by the movement of the gate of the cage thanks to the wind. The humans are looking to the sound and see: The tiger is free. Therefore all persons are running actively away from the tiger - without any power of the tiger. A behaviorist

would explain this with stimulus - response. Then Russell proposed a study design which allows causing just the information of the presence of the tiger but without its presence. This can be done e.g. with a loudspeaker behind a bush in a public garden where the persons are waking. We linked this situation with the information e.g. of mass media, that a tiger is escaped from a circus. We assumed a student how makes jokes with the persons: He caused the sound of the roaring of a tiger with his tape recorder. All persons will run away - just in consequence of the intellectual anticipating conclusion: This will be the escaped tiger. He can feed me! Now we change the sound to the trout quintet. Nobody will run away without one. The psychiatrist asks the person: Why you are running away: The psychiatrist would come to the conclusion: A normal reaction, if the person would answer: Oh, trout quintet - water - I have forgotten to close the water pipe in my bathroom. But he would assume the person would suffer on paranoia, if he would answer him: Doctor, run away, the tiger, the tiger. This demonstrates: The available theory about the given situation explains, what we can observe, what we cannot observe and in which way we have to interpret the phenomena. The difference can be fundamental: Active or passive movement, with and without anticipative attribution of meaning to observables. Normal or ill.

## 2) Common worldviews - paradigms - classic ontic positions

A medical doctor has to take in consideration that his patient can be a scientist: Then he can expect that his patient has - consciously or unconsciously - a paradigm for his special scientific field and its integration within a - usually unconscious - comprehensive paradigm, e.g. of the evolutionary nature of all what exists. But at the same time everybody has a lot of views of his daily life. All of them are integrated more or less within the actual valuations. This causes conflicts. Social scientist deal with them and speak then e.g. of inter- and intra-role conflicts, if e.g. the father is teacher of the son and had to evaluate him negatively. Maybe all persons have an ontic position about the fundamental of the world in the whole. So religious persons will accept e.g. the creation by God, atheists will avoid such a position. This ontic position can cover all other more or less selected world views including the integration of the scientific worldviews (they are called according to Th. Kuhn "paradigms"). The different views can be understood as subsets in the (ontic) basis set. We can expect that all these positions are balanced thanks to the individual personality of a person. The assumption of the set theory would have the consequence that all subsets are compatible with the universal set. We will use this position to make plausible the different paradigmatic positions of Einstein in SRT and GRT.

## **b. The background**

### 1) The stay of knowledge used by Einstein for SRT, GRT and cosmology

The stay of knowledge in physics - with focus on aspects for Relativity Theories - was restricted when Einstein developed the Relativity Theories (1905 and 1915) e.g. in relation to 1935 or today. Two classic theories ("Newton" and "Maxwell") with gravitation and electric and magnetic forces, different radiations including light and just one particle (electron) were known. Relevant mathematical tools were developed to deal more appropriate with transformations (e.g. Galilei, Lorentz, Riemann). Planck started a revolution with the discovery of the quantum. One of its expressions was the discussion about the nature of light: continuum or discontinuum. Einstein extended this position especially with the Relativity Theories.

His situation can be simplified according to the demands of a medical doctor: Einstein integrated that what is covered today with "light matter" and radiation into his position. He applied this for the first model of cosmology which was based on natural sciences: His static model. He had to integrate the cosmological constant  $\Lambda$  to stabilize it. Einstein had to skip out  $\Lambda$  later in consequence of the application of his formulas for others than the most simple one which was used by Einstein: Friedman and Lemaitre could demonstrate the correctness of the possibility of different types of dynamic universes. This was integrated only into Einstein's understanding of the cosmos but not into RT. The position of the expanding universe was later confirmed by Hubble empirically. The actual standard model of cosmology integrates the "Big Bang" and inflation with dark energy, dark matter, light matter and radiation. The actual discussion needs again the introduction of the identical constant  $\Lambda$  to explain the stability of our universe thanks to the integration of dark energy. We have to integrate a standard model of particles. The famous discussion between Einstein and e.g. N. Bohr about RT and Quantum-Theories was focused on the question how to deal with uncertainty and predictability of quantum processes. You can simplify this discussion on a discussion about the paradigm: Have we to accept a pre-determined universe (Einstein) or can we leave open this question (e.g. Nils Bohr). Heisenberg stands for a dissenting opinion: The uncertainty can be explained as expression of an Aristotelian *potentia*.

### 2) The paradigm of Einstein - based on the ontology of Baruch Spinoza

Einstein has understood himself, any person and all entities as finally determined. *"I am a determinist. As such, I do not believe in free will"*. /32/ But he assumed that it is not easy for us to recognize this. This is plausible if we integrate aspects of the religious philosophy of Baruch Spinoza into Einstein's universal set and its subsets of "world views". /33/ This lets explain also that the paradigmatic position for the SRT is

just a subset within this universal set and the paradigm for the GRT is more fundamental as the subset for SRT and very close to the universal set /34/ Therefore he could accept that any physical particle is able to recognize the position of other particles and avoid collision thanks to active and guided movement, but had to exclude emotionally the logical possibility that particles could have a freedom for a decision within a frame of restrictions - as Heisenberg proposed with respect to the Aristotelian potentia. Therefore he used his authority to stop such a discussion emotionally: *"I find the idea quite intolerable that an electron exposed to radiation should choose of its own free will, not only the moment to jump off, but also its direction. In that case, I would rather be a cobbler, or even an employer in a gaming-house, than a physicist."*

Nils Bor was one of the co-authors of the paper which caused this emotional argumentation. But Bor intended to remain neutral also to religious arguments because of humans would not be able to rule in which way god has to act. But he was also neutral to the position of Heisenberg. Bor did not introduce potentia but accepted a position in which this option was not excluded. So the Copenhagen convention is not a clear paradigm. More a handout which let open different paradigm, e.g. the paradigm of Heisenberg. So quantum theories have no paradigm in philosophical sense.

### 3) Basics of the religious philosophy of Baruch Spinoza

Spinoza (1632 - 1677) was a Jewish philosopher of religion. He deduced a pantheistic view from the fact that God would be ideal. Therefore, "nature" would be just another name for God. But even God is not free. He is determined thanks to his ideality. Therefore he is restricted to create the best possible and therefore ideal universe. The determining criteria for God are his divine natural physical and psychic laws, the logic and mathematics, especially the divine geometry. Therefore all what exists and acts has taking place ideal. God would consist of a single substance only but with infinite attributes. Humans - and possibly any entities - are restricted to deal just with the two attributes: with "meaningfulness" and "potential to deal with space" (close to the sense of Cartesian *res extensa* and *res cogitans*). But the actions of humans are determined by the effects of all the infinite attributes and their guidance to ideality. The difference in the diversity and complexity of very basic entities up to the very complex human persons is the result of the interactions and modifications which are conclusive thanks to the use of the two aspects. This does not influence the final determination to ideality even of a person but is the cause to believe in a free will and in negative and not ideal situations. Einstein has understood solid bodies and electromagnetic fields as very ancient but not fundamental. Therefore it made sense for him to attribute "beyond" of them a most fundamental physical entity: The energetic field. And it made also sense for Einstein to

attribute to them formulas which are inventions of the human mind to deal more appropriate with them.

No more fundamental physical entity can “beyond” the “energetical field” if we accept this philosophy. The only situation “beyond” that was the act of the creation of the universe. Then the restrictions of God would be directly in power: The restriction of God to act are based according to the power of geometrical mathematics. This chain of argumentation makes it conclusive why Einstein accepted mathematical formulas in SRT as free inventions of the human mind but explained the effects of general relativity theory with the omnipotence of God within his restrictions.

#### 4) To the area of conflict between science and religion

Spinoza created a deterministic relationship between religion and natural science. Einstein has taken over it. This interrelationship is not negligible from the medical point of view. This view excludes the traditional religiosity according to the world religions. Therefore the mosaic community has banished Spinoza. The health relevance of the active integration into a religious community is confirmed e.g. with classic studies. (e.g. Alameda County Study, started 1965) /35/. Such papers present a significant lower risk for leading mortalities and an increasing risk for wellbeing. This is seen to be associated with the effects of special attributions of meanings. Risk is not causality. A medical service which would be based on the exclusion of a causal connection of religion would accept negative health effects for the patient. This would be incompatible with the highest principle in Medicine: Not to cause harm (*Primum non nocere*). The position of a medical doctor should be independent from its personal religiosity open for the individual position of the patient. The position of Spinoza and Einstein explodes this position as not scientific. But the medical doctor is also responsible to offer his service on the basis of science. “Nature” is just another term for “God” for the pantheist Spinoza. Therefore science about nature is science about God. The determined-processes of Nature/God are liable to logic. The position is logically stringent that descendants must have characteristics of the progenies. Therefore the question would be a scientific one if you use the position of Spinoza or Einstein: What are the possible consequences of the limitedness of the ideal God on the nature of the universe? This question is the center of the interest of Einstein: *“What I am really interested in is knowing whether God could have created the world in a different way; in other words, whether the requirement of logical simplicity admits a margin of freedom.”* /36/ It is possible to formulate the question about ideality and determinateness in a scientific way, e.g.: *Is it possible to assume a not ideal world, which allows logical argumentations and is open for ideality?* This seems to be possible, if the starting point is the existence of not ideal and therefore restricted actors with the option to select intentions which are

intended to be ideal but cannot be realized ideal because of the fact that the actors are not ideal. The model of the Extended View is based on such a position.

This proposal has two consequences: One is dealing with science one with religion:

- The position let's open the origin of the natural laws and therefore the possibility that they can be understood as the expressions of subunit constituting consents and the option of their time-dependent occurrences (e.g. 2<sup>nd</sup> sentence of thermodynamics after the occurrence of atoms and their option to interact.)

- The proposal excludes the question about the nature of God from the field of science and attributes the question to the area of belief: This allows to believe as well in a God who takes care on individual persons e.g. thanks to grace as to a God without this attribute. Commonly it is accepted in religions that their basic is to believe and not the logic stringent scientific conclusion.

### **c) To C: Theory of principles**

Einstein presented first time his position to extend the stay of knowledge in his inauguration speech to the Prussian Academy of Sciences. /37/

He pointed out: *The theorist's ... work falls into two parts. He must first discover his principles and then draw the conclusions which follow them. For the second of these tasks he receives admirable equipment at school. ... The first of these tasks .... is of an entirely different nature. Here there is no method capable of being learned and systematically applied so that it leads to the goals. The scientist has to worm these general principles out of nature by perceiving in comprehensive complexes of empirical facts certain general features which permit of precise formulation. Once this formulation is successfully accomplished, inference follows on inference, often revealing unforeseen relations which extend far beyond the province of the reality from which the principles were drawn.*

#### 1) The application of a theory of principles to link former incompatible theories

He applied this technique to link indispensable theories which could not be linked before: There must be a joint position "beyond" such "incompatible" theories if they deal with in principle interrelated processes, as physical movement in mechanics or in electromagnetism. The incompatibility can be caused in consequence of the restricting paradigms and related used principles. But paradigms and the related terms, laws etc. are just inventions of the human mind to deal better with selected "real phenomena".

Therefore a more general invention of a joint principle "beyond" the incompatible principles should be possible. The invention is just one step "beyond" the give stay of knowledge: This step should allow an alternative way to predict the phenomena which can be predicted thanks to the each of the former incompatible theories but just with the

same principles. Therefore the “old” theories are not falsified. Their applicability remains as before on their classic problems. But additional power can be expected “*in provinces from which the principles were drawn and far beyond of them*”.

The technique starts with the question: *Is it possible to create a situation without the entities, which are matter of the special theories which should be linked, and to explain all the former explainable phenomena just with the newly invented characteristics?* In the special case of SRT: To invent an universe without electromagnetic fields and solid bodies and explain the phenomena which can be explained thanks to “Newton” and thanks to Maxwell/Lorentz with the invention of the SRT.

Now we have to distinct three steps: /38/

- Step 1 as Part one above: To invent a paradigmatic position with new principles which seems to be helpful to link the former incompatible principles. This is the philosophical-abstract part:

- Step 2 is related to the scientific fields which should be linked: The new principles have to be made compatible - in physics thanks to formulas - with the - in physics based on formulas - deductions on the basis of the old principles. This laborious process causes so long adjustments of the “new” formulas up to the point that all the phenomena which can be explained with the “old” formulas or such phenomena which should be explainable by them (e.g. the perihel of mercury) can be handled successfully with the new formula.

- Step three is identical with the second part of above: To apply the new principles on daily life problems including scientific ones.

Step 2 and especially step 3 are restricted to the experts of the related scientific disciplines. They are the “real winners” of the new principles: They can extend their field of application tremendously - as we have seen in physics in consequence of the SRT and GRT - without losing the power of the classic theories for classic problems.

## 2) The application on the Special Relativity Theory

To step 1:

Einstein modified the paradigm of Newton and Maxwell: Newton’s position was: Eternal divine Natural laws cause passive movement of any physical entity thanks to forces. Maxwell shared the same paradigm but substituted different forces with fields.

- Einstein modified their paradigms and created a world view in which all physical entities are moving actively with respect to the energetical relations between physical entities. His physical entities are able to deal with relationships.

- He postulated the energetical field “beyond” electromagnetic fields and solid bodies. Therefore the physical characteristics can be expressed just with the characteristics of this more fundamental entity.

- The joint aspect of energetic field, electromagnetic fields and solid bodies is their nature as carrier of energy.

Step 1 is the invention of a new world view/ paradigm. This is not physics but philosophy oriented on physical tasks.

To step 2:

The physical part was to adjust the characteristics of “energetical fields” in such a way, that all phenomena could be predicted with the identical results as thanks to the formulas of Newton and of Maxwell. This is possible with the formulas of SRT.

Therefore Einstein was able to characterize a situation of the universe without solid bodies and without electromagnetic fields thanks to his “invention” of energetical fields, but based on energetic fields as assumed physically existing carriers of energy.

To step 3:

This deals with the transfer of the paradigmatic positions into the physical formulas. This is not matter of this paper but of the experts in physics, cosmology and geophysics. The medical scientist can only draw on their help.

### 3) The application on the General Relativity Theory

Einstein started with the assumption of a physical situation without the energetical fields, and therefore without electromagnetic fields (and all types of radiation) and also without solid bodies. This can be seen - with respect to the world view of Einstein - as a situation of the universe before the creation of the world.

To step 1:

He postulated the principle of equivalence and the principle that in the ideal divine nature the ideal and therefore simplest option will be realized. He introduced - as he pointed out later - a new type of ether: / 39/ The time-space determined and physically powerful geometric basis of the universe. Physical entities and the novel ether are able to interact according to geometric-timespace potential of the novel ether and according to the relationships between the really existing energies of the entities in a mathematically predictable way - if such entities are present. Maybe such an argumentation sounds for many persons not very understandable and therefore “typical for theoretical physics”: But this type of argumentation is not a natural science argumentation. It is a proposal for an imagination of the universe. This is a proposal for a world view and is therefore close to philosophy.

To step 2:

He used the available empirical data - maybe with a special focus on the data of the unexplained movement of the perihelion of mercury /40/ - and the fact of the speed of the light as the highest possible speed for carrier of energy and information within time and space according to the SRT. To handle was the interaction of existing physical



entities with a theoretically effective structure with a more fundamental background in which time and space were not distinct

To step 3:

Einstein and Hilber used complex mathematical tools to integrate these phenomena generally within a time- focused time-space geometrical grid and for each single carrier of energy within the SRT. The result was the General Relativity Theory. This is not matter of this paper but of the experts in physics, cosmology and geophysics. This paper focuses on the compatibility with health aspects. Therefore there is no discussion about the power of the physical formulas created by Einstein and Hilber on the invented postulates of Einstein. It is brought in memory: This contribution is oriented on the health relevant aspects. Therefore it is only relevant if the used conclusions from the applied paradigms are compatible with the health effects. Every proposal for a world view would be acceptable, which would be plausible that the undisputed formulas of the General Relativity theory and SRT can be deduced from them. The assumption seems to be not more strange that Most Basic Entities made agreements which cause the same effects which can be handled thanks to the formulas of the General relativity Theory as the assumption of an idealistic ether which is filling the whole universe with just one effect: To guide the most fundamental physically existing entities according to formulas which are not two hundred years old. Up to now no contradiction could be observed between the proposed paradigm as ground set for the different health related paradigms as subsets.

#### 4. To the differences between the two paradigmatic positions of SRT and GRT

The SRT is based on the assumption that theories are free inventions of the human mind (of Einstein) to deal better with the finally not known reality. Mathematic is a tool without any influence on reality. The relevance of mathematics is fundamentally different in the GRT: The GRT would not allow any prediction without the physical power of the time-space determined mathematical geometry. Both positions seem to be excluding each other. But it fits if we attribute to Einstein a set theoretically based structure of his world views with his religious position as universal set and scientific paradigms as subset. The GRT is based on the ability of mathematical formulas of geometry to interact with physical entities and the ability of physical entities to interact not only with other physical entities but also with the postulated physical power of geometry. This brings the same problems as the substance dualistic model of Descartes. These were one of the reasons to understand Vis Vitalis and similar position as falsified.

## 5. Discussion about the perception of the GRT

The power of the GRT for relevant predictions with influence even for the daily life is generally accepted. Not so its background. We focus on the analyses which were made on occasion of the 100<sup>th</sup> birthday in the publication of Aichelburg and Sexl, which was published under the patronal of the International Society on General Relativity and Gravitation. /41/

Carl Friedrich von Weizsäcker honored the creation of the GRT as the only relevant physical theory which would not be available if its creator - Einstein - would not have existed". *But ...the relationship of this theory to the rest of physics is up to now not really clear. The theory is to compare with an unredeemed partial payment for anything up to now unknown; Einstein himself has seen this similar"* /42, 43/.

Einstein confirmed this position in his last lecture (Princeton, April 1954) /44/: *"The description of matter in the GRT thanks to a tensor is a makeshift, anything transient; similar a "wooden nose on a snowman". The GRT was not complete, because we now, that there are not only gravitational fields" ...This cause the impression that the GRT is not more truthful as any other classic theory."* Therefore he worked decades on a General Field Theory. But we know: He was not. Even Einstein did not claim that the General Relativity Theory is complete.

## 6. "Outside" of the power of the GRT

Einstein's classification of the GRT as "one of the classic theories" advises to apply the positions on the GRT which Einstein has used generally.

This position includes: The GRT is a free invention of the (Einstein's) human mind. It is based on an invention about a new paradigm. This paradigm empowered us to the transfer of the paradigmatic inventions to formulas which predict phenomena which could not be predicted before. This is in principle the same situation as it was after the inventions of Newton and Maxwell/Lorentz. There is no scientific argument that the paradigmatic position of Einstein cannot be modified as long as the formulas persist for the applied aspects which could be predicted with the GRT.

We have to expect topics which are "outside" of the power of any "classic theory", therefore also outside of the power of GRT: e.g.

- The unbridged gap between the powerful quantum theories,
- The empirically confirmed fact of non-locality, that information of processes with special photons of laser can have effects which are transmitted with a higher speed as the speed of the light (e.g. teams of Zeilinger, Aspect and others) /46/
- Einstein could not explain the nature of mass but offered just a formula how to deal with.

- The use for the cosmological models had to be modified two times: Einstein had to skip Lambda out because of the fact that the postulate of the simplest realization was falsified. Now Lambda had to be integrated again. This was needed to make conclusive a much more complex standard model of cosmology.

- Unexplainable but reproducible phenomena in connection with gravitational waves were measured with antennas of gravitational-radiation detectors (Weber J) /47/.

- The GRT is very often not in use in geophysics or would cause predictions which are incompatible with the phenomena. The restriction of the applicability of the General Relativity Theory for geophysical tasks of earthquakes and tsunami is a relevant challenge for science but also for healthcare: Earthquakes and tsunami cause very relevant health effects. The traditional offers for their predictions are not sufficient. Khalilov has developed for both new methods and techniques. They are based on principles to deal with the gravitational field and its modification as prerequisites for predictions and technical approaches to prevent the consequences e.g. on houses. This is topic of the next contribution in this book /48/.

## **VI Compatibility With The Extended View**

### **a. The integration of an evolution based understanding**

Einstein claimed the integration of all aspects of our universe including e.g. life for complete theories of physics. A basic theory for life is the acceptance of the evolutionary process. Einstein did not integrate this idea into his models. This is done within the Extended View. But there are not real difficulties in the applicability of the technique for theories of principles. Einstein started his argumentation with the proposal to invent a physical position of the universe without the existence of electromagnetic fields and without any solid body but with energetic fields “beyond” them. This corresponds to the actual model of cosmology: Electromagnetic fields have a history. The electromagnetic fields can be understood as precursors of the radiation and particles of dark and light matter. So the electromagnetic field can be understood as “grandparents” of solid bodies (=light matter). The formula of SRT can be understood as the express of the processes which could be realized thanks to the potential of the really existing physical entities. Gravitation interact just with electromagnetic fields and dark and light matter, but not with dark energy. This is a challenge which will be discussed in the next publication. But this fact let expect that electromagnetic fields are not the most ancient entities in the universe within a model which covers also the standard model of cosmology. “Beyond” the period with Einstein described with the SRT an ancient situation of our universe without electromagnetic fields and solid bodies but energetical fields. The implicit postulation of a situation without electromagnetic

field and any matter as precursor for the situation with electromagnetic fields and (later) of solid bodies fits to the actual state of knowledge for the cosmic evolution. He postulated that electromagnetic fields and solid bodies could create themselves on the basis of energetic fields.

### **b. The integration of principles of the extended view**

The proposal of the Extended View is based on the paradigmatic position that predictable phenomena can be explained with subset constituting agreements thanks to additional WIN. The agreements are not exactly predictable from the characteristics of the precursors. The agreements are matter of voluntariness but have to be made within the frames set in consequence of the consents of the precursors. Therefore there is no logic way from the phenomena caused by the precursors to the used application as subset constituting consents. The consents can only be detected thanks to empirical testing.

We have attributed two types of consents to each individual actor:

- The more simplified consents for the outside relations to others which sharing the same subset-constituting consents. Their motivation is to give respect to the demands of “others” to realize the possible options for wins. (“observers of chess-players”)

- The more differentiated inside oriented consents between the actors to use the options which are offered thanks to the subset constituting consents. Their justification is to improve the surplus e.g. to win. (e.g. The rules of chess or the follow up of steps for waltz)

- But the indispensable prerequisite to accept the consents is seen in the individual win of each single actor: The consents open new types of options for individually free decisions within the frames of the agreements. The individual application cannot be known or predicted by an outside observer e.g. a scientist. The correct application of the consents can be predicted.

The problem of uncertainty of the single case but of predictability in large numbers can be seen as solved, if you accept the model of consents and freedom within them. This would be in agreement with the position of Heisenberg in his understanding of Copenhagen convention. The related positions of two types of consents can maybe used for a special interpretation of aspects of the formulas of Einstein for the GRT: It is remarkable that the GRT covers processes not only processes depending on space-time but also - even with the speed of the light - depending on the SRT. The SRT is based on effects depending on time and space. The SRT has to be applied for each individual actor on its individual position (“world point”), the GRT for the processes in relation to all entities within the universe. This fits to the two types of consents described above: A more distinct approach can be helpful to deal with the inner view of the single actor. Therefore a distinct integration of time and space is maybe adequate. Generalized effects

can be handled with a more simplified approach. Space-time can be understood as the consequence.

Paradigms should make plausible the effects which can be handled with the related formulas in physics. The paradigm of the newly created ether as basic geometrical determinant of the universe is maybe conclusive for the better imagination and therefore for the easier acceptance why formulas are able to produce reproducible physical phenomena. But this proposal is not helpful if you are interested to integrate processes of life, of emotional, intellectual and cognitive in reality. But even these processes should be made reasonable as easy as possible. This justified the attempt to create another paradigm which is in agreement with the same formulas.

## **VII Conclusions**

### **a. No need for a modification of the Extended View to be compatible with the power of GRT**

Einstein accepted the active guidance for individual movement of particles to avoid crashes. So he was not far away from the attribution of a not physical ability. But the model of Spinoza did not allow this. What would have been if Einstein would have been a tradition religious Jewish person and would have accepted free decisions within the frame of subunits constituting consents and not within the borders of the determining divine laws? There would not be any reason that the formulas of SRT and GRT would be different! Neither the paradigm of Einstein with in principle powerful space time determined geometry nor the paradigm of the Extended View express directly the formulas to deal with the processes. In both cases the formulas have to be "*wormed by perceiving in comprehensive complexes of empirical facts.*" But the paradigm of Einstein does not allow to deduce why this is so but the paradigm of the Extended View: This paradigm attribute to the actors the freedom to select between different option. The scientist has not only to invent in the area of conflict of the reproducible phenomena the simplest compatible formula. The natural scientist struggles to "re-invent" as close as possible the decisions of the ancient inventors on the basis of the related phenomena. It is not possible to deduce from Einstein's paradigm why the processes of each single physical actor has to integrate time and space (according to SRT) but space-time in the general. The Extended View can give an offer for that. The used paradigm does not influence the selection of the empirical facts which are used to develop the formulas. Therefore it is to expect that Einstein (and Hilber) would have developed the identical formulas if they would have used the paradigm of the Extended View. Therefore the health relevance of the GRT does not depend on the used paradigm. As a result there cannot be a physical scientific method which could falsify the usefulness of the Extended View.

**b. General applicability of the paradigm and the epistemology of the Extended View**

The application of this chain of argumentation on all natural laws and natural constants results in the conclusion that natural laws and natural constants are the result of logically not predictable decisions. Their exact formulas and characteristics can be discovered/reinvented just on the basis of empirical studies. The freedom for their invention has been restricted thanks to the need on compatibility with the given consents. Therefore it is not an unbelievable coincidence that e.g. the masses etc. of the particles of the standard model fits together if you accept the model of the Extended View. Therefore the model of the Extended View excludes the option, that all natural laws and natural constants are present since the starting point of our universe. They have a history. This makes plausible that the consent for the second sentence of thermodynamics was agreed when interactions between atoms could take place. We could not find evidence that the model of a space-time based ether (Einstein 1920) is helpful for the understanding of just one process on a younger level than of gravitation.

**c) The power to link with the surplus thanks to emotional, intellectual and cognitive efficiency**

The compatibility of the basis paradigm is crucial for medicine not only between the sectoral paradigms of natural scientific disciplines but with health relevant disciplines which are based on aspects which cannot be handled sufficiently just with energy-matter based processes. The example of chess confirms the needed power: The figures are from matter but not their relevance for the game: Their characteristics are based on the agreements about the attributed meaning. The attribution of meaning is not a physical-energetical effect. The attribution of meaning to a constellation during the game is the reason for a special move. The prerequisite to move a figure is the available energy of the mover. The guidance to a special field is not to explain sufficiently with energy alone: There is a need also for discrimination ability.

**d) The discovery of discrimination (ability)**

The acceptance of the discovery of discrimination (ability) is indispensable for the extended understanding of reality, Wirklichkeit and virtuality - as it is common in daily life but not in science. This step allows to deal with the guidance of and the attribution to meaning to efficiencies. (The ability thanks to Energy can be expressed with the metaphor of the fuel and discrimination (ability) of the facility to guide e.g. thanks to steering wheel. Maybe there is no process without both of them.

**e. The inalienability of philosophical abstract fundament of concrete-scientific research**

The metaphor of the tiger in the park makes obvious the position of Einstein, that the philosophical abstract “theory” defines what can be observed. The metaphor support the statement of Heisenberg that the theory restricted what cannot be observed. But also in which way the phenomena have to be explained. The same Process has to be explained as passive movement, as active movement with and without anticipation, as mentally normal or paranoid - just depending on the used “theory”. Such differences are of fundamental relevance - especially for medical doctors.

**f. Paradigms are simplified inventions about the nature of objects and their interactions**

This confirms the fundamental relevance of paradigms and their adequate use. The acceptance of just one evolutionary process has the consequence that there should be one paradigm which should cover all aspects of the different theories. But the evolutionary process is linked with a relevant shift of that what is relevant and wot is never relevant. Therefore the comprehensive paradigm will be form the position of plausibility impressive: as he statement “any natural law can be understood as created jointly with the universe “ or “All natural laws are the attempt of scientists to re-invent that what the ancient actors have agreed to incise its individuals win thanks to WINWIN”. So the paradigmatic part is relatively easy and powerful over many sectoral disciplines. But the transfer of the paradigmatic position is the real difficult work and depending on the special aspects of the disciplines. Therefor it is clever to develop paradigms just as tool which are adjusted to the demands of the sectoral disciplines. So you can use the economic way according to the given. The interpretation of then formulation decides: Is it just a tool an can substituted by another paradigm if the problem is different? Let the formulation to option open that the paradigm can be a subset within a ground set which covers the whole evolutionary process of e.g. health? As long as these two questions can be answered with “yes” then to door remains open for the holistic medicine. This let expect additional scientific power of medicine for patient and clients. Once the epistemological and ontic formulation for a sectoral discipline within the frame of the unique evolutionary process is successfully accomplished, *then* - as Einstein prognoses - *“inference follows on inference, often revealing unforeseen relations which extend far beyond the province of the reality from which the principles were drawn”*.

Nevertheless we have to expect the real win for the experts of the sectoral disciplines. They are able to use their specialist knowledge, skills and attributed to

integrate the principles of the “province of reality” and combine them with their traditional scientific tools.

**g. Determinism versus free will**

The (free) decision for the paradigm definite the type of worldview: determinism or indeterminism. The challenge for the determinist (e.g. Einstein) is the uncertainty of the single case. The followers of indeterminism have their problems to explain the nature of the restrictions of the free will and of the undisputable predictability of many processes. The proposed principle of WINWIN makes plausible as well the individual arbitrariness and therefore the uncertainty for the observer as the nature of the frames for freedom and the nature of the predictable.

**h. Paradigms and Principles: simplifying inventions about the nature of objects and options for interactions.**

Nevertheless we should have all the time to recognize: Paradigms and principles are simplifying inventions and therefore from another nature than that for what they should stay. No paradigm can claim the assumption that we would now know “*what holds the world together in its innermost*” /49/. Therefore any “theory” must have frames of its power. Therefore it makes sense to select paradigms problem oriented and “temporarily” but all the time open for linkages to the neighboring sectoral disciplines and topics.

**References**

1. Kofler W: Epistemological and ontological tools for an Extended view of a human person as a social being and its environment, part 2: The increasing inhomogeneity of the power of science and an “Aristotelian“ proposal to cope with. *Biocosmology - Neo-Aristotelism*, 8, 3&4, 2018 430 – 446.
2. Khalilov E., W. Kofler: Earthquakes and Tsunamis - A challenge for the Extended View, *Science without Borders*, Vol, 4, ISBN..... 2018/2019 p.
3. Engel GL: The need for a New Medical Model: A Challenge for Biomedicine, *Science*, 196, 4286, 129 – 196, 1977
4. Kofler W.: Pfizer ends Alzheimer-Research-An Emergency Signal for Medicine and Politics, *Herald of the International Academy of Sciences. Russian Section*, 2018, 1, 56 – 62
5. [https://www.pfizer.com/news/featured\\_stories/featured\\_stories\\_detail/learn\\_more\\_about\\_our\\_neuroscience\\_r\\_d\\_decision](https://www.pfizer.com/news/featured_stories/featured_stories_detail/learn_more_about_our_neuroscience_r_d_decision)
6. Kofler W: Think global - act problem oriented and local: can an extended view increase the power for interdisciplinarity, *Herald of the International Academy of Sciences. Russian Section*, 2017, 1, 6 – 10
7. Kuhn Th.: *The structure of scientific revolution*, Univ. Chicago Press, 1962



8. Kofler W. Philosophy for fundamental science and applied medicine, Herald of the University St. Petersburg, Medicine, 109 -124, 2015
9. Therefore first the resistance has to be overcome against the expected loss. The prerequisite for the transfer to the new situation should be the equivalence between the wins which are resulting from the newly accepted situation and the related loss. Maybe this is a door to a general understanding of the equivalence-principle!
10. Brody et al.: Prevention Effects Ameliorate the Prospective Association Between Nun-supportive and Diminished Telomere Length, *Prevention Science: The official Journal of the Society for Preventive Research*, 16, 2 (February 2015) 5944-5949, doi:10.1073/pnas.1404293111
11. Blackburn E., Epel: The telomere effect, Grand Central Publisher, NY, 2107
12. Velizer GJ, Yuen-Tsu: Evolution of novel cooperative swarming in the bacterium *Myxococcus Xanthus*, *Nature*, 425, 4.9.2003 M. Planck Gesellschaft, Inst. f. Entwicklungsbiologie, Aussendung 4.9.2003
13. Russel Bertrand: *Das ABC der Relativitätstheorie*, Fischer, Frankfurt a M, 1989, p 150 (in German)
14. Original in German: *Das Weltbild der theoretischen Physik.. erhebt den Anspruch. für jeden Naturprozess gültig zu sein... einschließlich der Lebensvorgänge, wenn jener Prozess der Deduktion nicht weit über die Leistungsfähigkeit menschlichen Denkens hinausgeht. Der Verzicht des physikalischen Weltbilds auf Vollständigkeit ist also kein prinzipieller. Höchste Aufgabe der Physiker ist also das Aufsuchen jener allgemeinsten elementarsten Gesetze, aus denen durch reine Deduktion das Weltbild zu gewinnen ist. Zu diesen elementaren Gesetzen führt kein logischer Weg, sondern nur die auf Einfühlung in die Erfahrung sich stützende Intuition.“* (Prinzipien der Forschung, 60. Geburtstag von Max Plank 1918
15. Kofler W., P. Lercher, M. Puritscher: The need for sufficiently taking into account unspecific effects in the understanding of health risk: Part 1: Unexplained phenomena, Part 2: Epistemological limitations and offers for solution, Part 3: Prove of the proposed solution by an experimentum crucis, IUAPPA and Korean Society for Atmospheric Environment, Seoul, (on CD-ROM), F 0245a,b, c, 2001
16. Kofler W. Information” from an Evolutionary Point of View, *Information*, 2014, 272-284; doi: 10.3390/info5020272
17. Bayer U., OS Glazachev, R. Likar, M. Burtscher, W. Kofler, G. Pinter, H Stettner, S. Demtschar, B Trummer S Neuwersch: Adaptation to Intermittent Hypoxia-Hyperoxia Improves Cognitive Performance and Exercise Tolerance in the Elderly, *Advances in Gerontology*, 7,3,214 -220, 2017
18. Kofler W.: The relevance of Sechenov for the development of the theory of an “Extended view” of a human person as a social being, *Russian Academy of Science & Russian Academy of Medical Science, Series: Sechenov Honor Lectures 2004, Moscow*, 3 – 68, 2005

19. Heisenberg: Physics and philosophy - The revolution in modern Science, Greater Minds Series, Prometheus Books, NY, 1999, orig. Harper & Ro2, NY 1958
20. Kofler W., Puritscher M. Alienation as an instrument for a constructivistic interpretation of evolution and of Heisenberg's uncertainty relationship. In: van Dijkum C, de Zeeuw G, Eds. Methodological explorations in constructive realism, Amsterdam: Socrates Science Publisher, 1993
21. Kofler W: Konstruktiver Realismus und ein anwendungsorientierter Zugang zu Gesundheit und Umwelt, in: Holzenthal N.(ed.) Constructing Reality/ Realität konstruierend, Edition Peter Lang,(in German) Frankfurt, 79-97, 2016
22. Einstein A: Äther und Relativitätstheorie, J. Springer, Berlin 1920
23. Saussure F.D. Cours de linguistique générale, (Bally Ch. A Sechehaye eds.), orig. 1916, De Gruyter 1967
24. Schilpp P.A. Albert Einstein – philosopher – scientist. The library of living philosophers, VII, La Solla, 1949
25. Weizsäcker Carl Friedrich v: Einsteins Bedeutung in Physik, Philosophie und Politik, in Aichelburg PV RU Sexl (eds.) Albert Einstein: Sein Einfluss auf Physik, Philosophie, und Politik, Vieweg, 1979, 165 - 176
26. Einstein A., L. Infeld, The Evolution of Physics, Cambridge University Press, (1938)
27. E.g. Einstein A, B Podolski, N. Rosen: Can Quantum-Mechanical Description of Physical Reality be considered Complete? Physical Review, 47, May 15, 1935, 777-780
28. Heisenberg W. Der Teil und das Ganze (Piper, München, 1971), S. 92:
29. Heisenberg W., cited by Holton G., Themata Vieweg, Braunschweig, Wiesbaden, 1984 S. 169n
30. Russell B: The ABC of relativity theory, Routledge, London, NY, edition 1997
31. Kofler W. Philosophy for fundamental science and applied medicine, Herald of the University St. Petersburg, Medicine, 109 -124, 2015
32. “ I am a determinist. As such, I do not believe in free will. The Jews believe in free will. They believe that man shapes his own life. I reject that doctrine philosophically” Einstein: His Life and Universe by Walter Isaacson, p. 387
33. “I believe in Spinoza's God, who reveals himself in the lawful harmony of the world, not in a God who concerns himself with the fate and the doings of mankind, 24 April 1929 in response to the telegraphed question of New York's Rabbi 34. Herbert S. Goldstein: "Do you believe in God? Stop. Answer paid 50 words." The New York Times 25 April 1929 We followers of Spinoza see our God in the wonderful order and lawfulness of all that exists and in its soul as it reveals itself in man and animal. letter to Eduard Büsching (25 October 1929 “The God Spinoza revered is my God, too: I meet him every day in the harmonious laws which govern the universe..... My God speaks to me through laws. William Hermanns, Einstein and the Poet: 1983, p 89

34. "What I am really interested in is knowing whether God could have created the world in a different way; in other words, whether the requirement of logical simplicity admits a margin of freedom."
35. Belloc B, Breslow L.: Relationship of physical health status and health practices, *Prev. Med.*, 1972; 1:409-421; Housman J, St. Dorman: Th Alameda County Study: A Systematic, Chronological Review, *Am J Health Education*, 36,5, 302-308, 2005
36. Einstein and Religion, in Carl Seelig, (ed.), Princeton University Press, 1999, p. 124
37. Einstein A: Prinzipien der Theoretischen Physik, Inaugurationsvortrag Preußische Akademie der Wissenschaften, Proceedings, II, 739-744, 1914, English in: Ideas and Opinions, Three Rivers edition, 220-223!
38. Einstein has summarized these steps in a stringent text and an obvious sketch in his letter to his friend Maurice Solovine 1952
39. Einstein A: Äther und Relativitätstheorie, J. Springer, Berlin 1920 in German
40. Einstein A: Erklärung der Perihelbewegung des Merkurs aus der allgemeinen Relativitätstheorie. in: Sitzungsberichte der Königlich Preußischen Akademie der Wissenschaften. 1915,II. S.831-839 in German
41. Aichelburg PC & RU Sexl (eds.) Albert Einstein: Sein Einfluss auf Physik, Philosophie und Politik, Vieweg Braunschweig/Wiesbaden, 1979 in German
42. German: „The allgemeine Relativitätstheorie ist Einsteins ureigenste Leistung. Unter allen bekannten großen Theorien der Physik ist sie die einzige, bei der man zweifeln kann, ob sie bis heute überhaupt gefunden worden wäre, wenn derjenige nicht gelebt hätte, der sie gefunden hat.....Freilich ist.. die wahre Beziehung dieser Theorie zum Rest der Physik bis heute nicht wirklich klar. Die Theorie ist wie eine uneingelöste Anzahlung auf etwas noch Unbekanntes; so hat Einstein sie selbst empfunden.
43. Weizsäcker CF von: Einsteins Bedeutung für Physik, Philosophie und Politik, in Aichelburg PC & RU Sexl (eds.) (rest see above) 1979 165 -175 in German
44. Einstein A: The last lecture, presented 14 4 1954 in Princeton University, noted by JA Wheeler, published by JA Wheeler in: Mercer Street und andere Erinnerungen, in Aichelburg PC & RU Sexl (rest see above), 1979, 211-221 in German
45. in German: „Die Beschreibung der Materie in der ART durch einen Tensor ist ein Lückenbüßer, etwas Vorübergehendes, wie eine „Holznase an einem Schneemann“. Die ART war nicht vollständig, da wir wissen, dass es nicht nur Gravitationsfelder gibt. .... Dies gibt einem das Gefühl, dass die ART nicht wahrer ist als irgend eine andere klassische Theorie.“
46. E.g. Gröblacher S et al, A Zeilinger: An experimental test of non-local realism. *Nature* 446, 871-875, 2007
47. Weber J.: Gravitationsstrahlung, in: Aichelburg &Sexl, oao., 27 - 34 in German
48. Khalilov E., W Kofler: Earth quakes and Tsunami: a challenge for the Extended View, *Science without Borders*, Vol IV
49. Goethe W. : Faust I, 1808

## **MEDICINE AND BIOLOGY**

### **PERSONALIZED BLOOD PRESSURE CHRONOTHERAPY**

**Yoshihiko Watanabe<sup>1</sup>, Kuniaki Otsuka<sup>1</sup>, Germaine Cornelissen<sup>2</sup>**

***Franz Halberg<sup>2</sup>***

<sup>1</sup> *Tokyo Women's Medical University, Tokyo, Japan;*

<sup>2</sup> *University of Minnesota, Minneapolis, MN, USA*

#### **Aims**

To determine whether the timing of administration of Losartan potassium/Hydrochlorothiazide (L/H) can be optimized along the circadian scale and to assess the extent to the optimal circadian stage differs from one patient to another.

#### **Background.**

Large studies on rodents amply documented that treatment timing can make a great difference in outcomes, sometimes between life and death (1). Small pilot studies in humans have also demonstrated the gain that can be obtained from optimizing the circadian stage of treatment administration (2, 3). In the case of low-dose aspirin, we also learned that the best treatment time to reduce toxicity differs from that to lower blood pressure (BP) or to prevent blood coagulation (4).

#### **Subjects and methods.**

Fifteen patients automatically measured their systolic (S) and diastolic (D) blood pressure (BP) and heart rate (HR) around-the-clock at 30-minute intervals for 7 days first without L/H and thereafter after at least one month on L/H administered at a given circadian stage, at awakening and 3, 6, 9, 12 and 15 hours after awakening, with monitoring during the last week on a given timed treatment.

Each record was analyzed by sphygmochron overall and separately for each day of the 7-day profiles. Estimates of the MESOR (M) and 24-hour amplitude (A) corresponding to the 6 treatment times were compared by one-way ANOVA and by

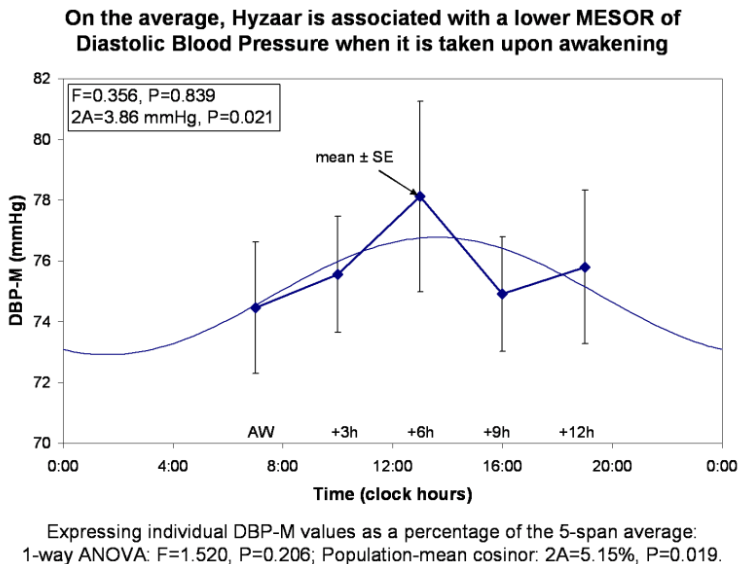
cosinor (parameters being assigned to the time of treatment in relation to awakening) separately for each patient as well as for all 15 patients.

**Results.** On the average, the MESOR of DBP is lower (Fig. 1) and the circadian amplitudes of SBP and DBP are smaller (Figures 2 and 3) when L/H is administered upon awakening.

An effect of L/H on the circadian amplitude (A) of BP is not trivial since several outcome studies have shown that when the BP-A is excessive (above the upper 95% prediction limit of BP-As of clinically healthy peers matched by gender and age), a condition known as CHAT (Circadian Hyper-Amplitude-Tension), there is a large increase in cardiovascular disease risk (5).

An effect of circadian stage of L/H administration on the circadian BP-A (as well as on the MESOR) can also be demonstrated on an individual basis for some patients. For Su (M, 67y), the presence of CHAT in the absence of treatment is exacerbated when L/H is taken 6 hours after awakening, but it is alleviated when the same dose of L/H is taken in the evening, 12 hours after awakening, Fig. 4.

For MA (M, 61y), SBP-M, DBP-M and pulse pressure (PP) are lowest around 6 hours after awakening ( $P < 0.001$ ), while his SBP-A and DBP-A reach the upper level of acceptability when L/H is taken 3 hours before bedtime (SBP:  $P < 0.001$ ; DBP:  $P = 0.003$ ), Fig. 5-9.



**Fig. 1. © Halberg**

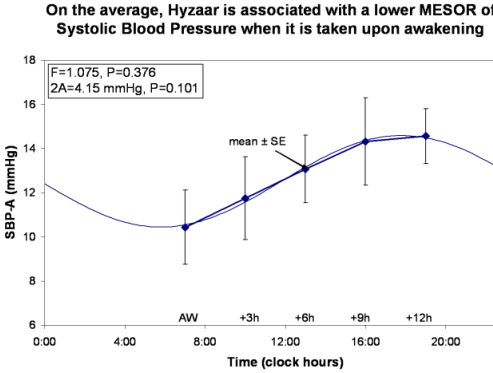


Fig. 2. © Halberg

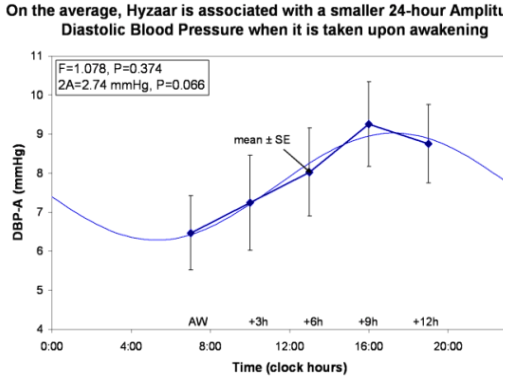


Fig. 3. © Halberg

**Mild 7-day CHAT (left), exacerbated by Treatment (Rx) at the wrong time (middle) but eliminated by Rx at the right time (right)**

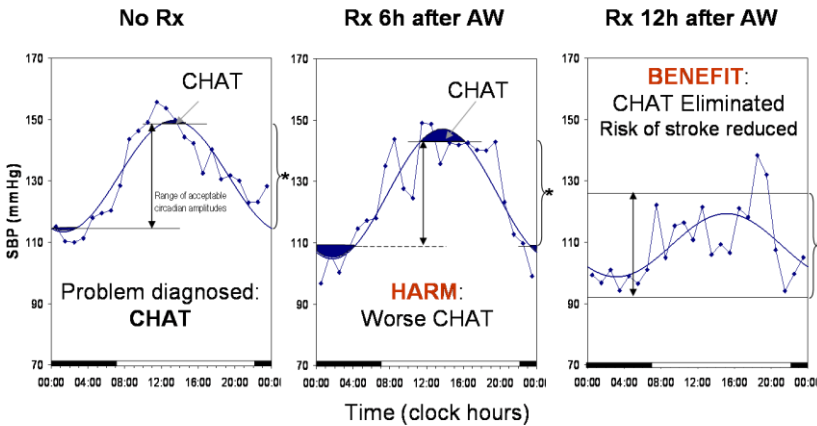


Fig. 4. © Halberg

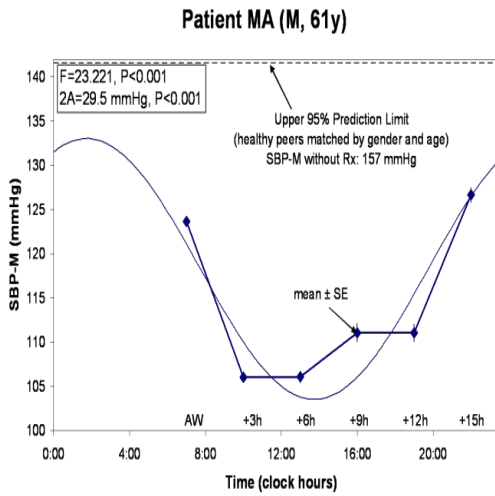


Fig. 5. © Halberg

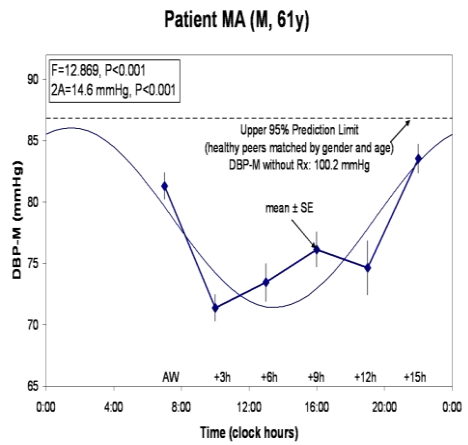


Fig. 6. © Halberg

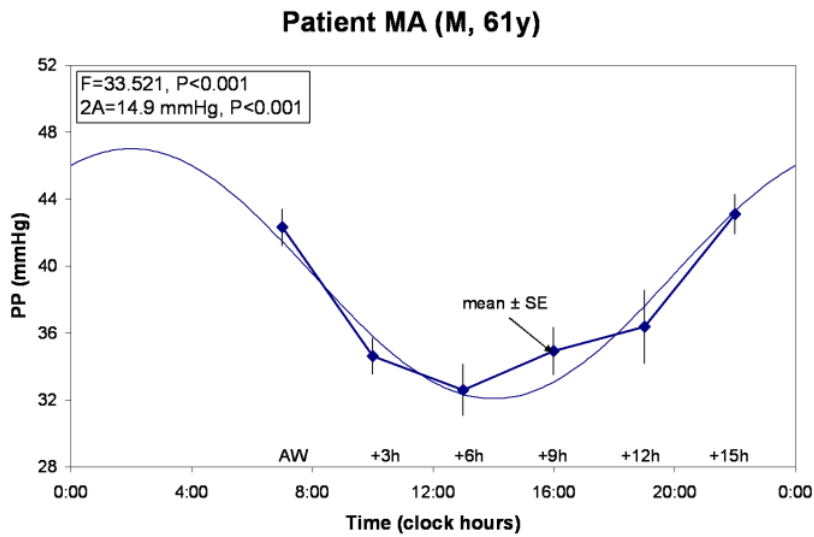
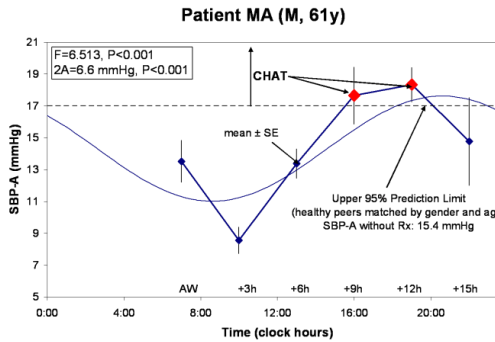
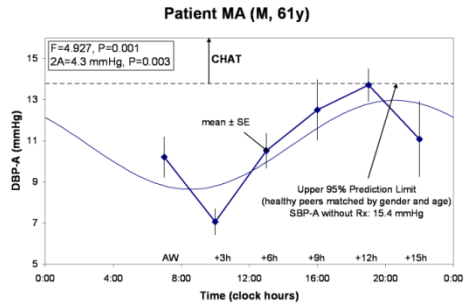


Fig. 7. © Halberg



Hyzaar Rx at some circadian stages induces CHAT, a risk factor of cerebral ischemic event and nephropathy larger than MESOR-hypertension.

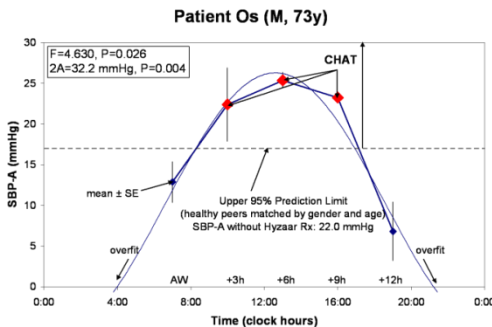
Fig. 8. © Halberg



Hyzaar Rx at some circadian stages may induce CHAT, a risk factor of cerebral ischemic event and nephropathy larger than MESOR-hypertension.

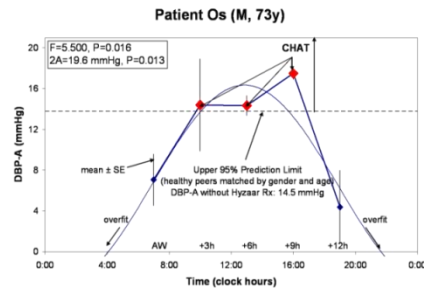
Fig. 9. © Halberg

For patient Os (M, 73y), SBP-A and DBP-A are excessive (corresponding to CHAT) when L/H is taken around mid-day (SBP:  $P=0.004$ ; DBP:  $P=0.013$ ), Fig. 10 and 11.



Hyzaar Rx at some circadian stages induces CHAT, a risk factor of cerebral ischemic event and nephropathy larger than MESOR-hypertension.

Fig. 10. © Halberg

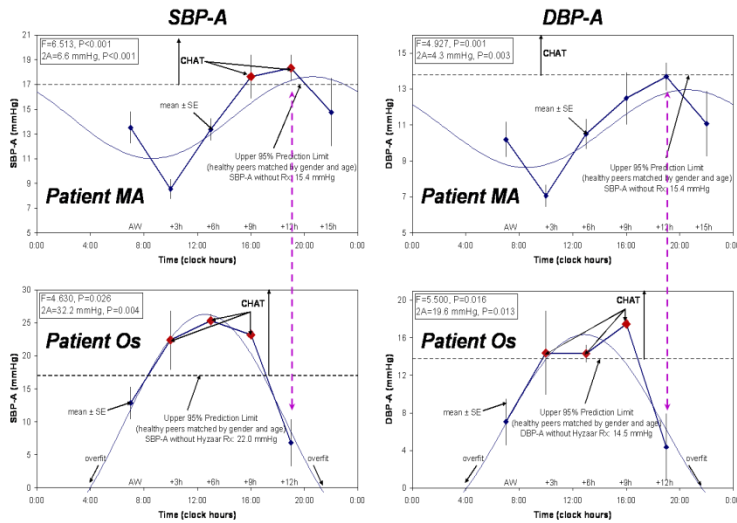


Hyzaar Rx at some circadian stages induces CHAT, a risk factor of cerebral ischemic event and nephropathy larger than MESOR-hypertension.

Fig. 11. © Halberg



**Need for Individualization: Hyzaar at AW+12h is associated with an exacerbation of CHAT for MA and with its elimination for Os**



**Fig. 12. © Halberg**

**Discussion and Conclusion.**

Patient Su discussed earlier (6, 7) is no exception. There are other patients for whom L/H can help or hurt depending on when it is taken by decreasing or increasing the circadian BP-A. Individual differences in terms of optimal timing on the BP-M as well as on the BP-A are sufficiently large to advocate optimization for each patient separately, Figure 12. With inter-individual differences, an overall time effect is demonstrated for DBP-M (P<0.05).

**References**

1. Halberg F., Cornelissen G., Katinas G., Syutkina E.V., Sothorn R.B., Zaslavskaya R., Halberg Francine, Watanabe Y., Schwartzkopff O., Otsuka K., Tarquini R., Perfetto P., Siegelova J. Transdisciplinary unifying implications of circadian findings in the 1950s. *J Circadian Rhythms* 2003; 1: 2. 61 pp.
2. Günter R., Herold M., Halberg E., Halberg F. Circadian placebo and ACTH effects on urinary cortisol in arthritics. *Peptides* 1980; 1: 387-390.
3. Cornelissen G., Halberg F., Prikryl P., Dankova E., Siegelova J., Dusek J. International Womb-to-Tomb Chronome Study Group: Prophylactic aspirin treatment: the merits of timing. *JAMA* 1991; 266: 3128-3129.

4. Cornelissen G., Halberg F. Chapter 11: Treatment with open eyes: markers-guided chronotherapeutics. In: Youan BC, ed. Chronopharmaceutics: Science and Technology for Biological Rhythm-Guided Therapy and Prevention of Diseases. Hoboken, NJ: Wiley; 2009. p. 257-323.
5. Otsuka K., Cornelissen G., Halberg F., Oehlert G. Excessive circadian amplitude of blood pressure increases risk of ischemic stroke and nephropathy. *J Medical Engineering & Technology* 1997; 21: 23-30.
6. Watanabe Y., Cornelissen G., Halberg F., Beaty L., Siegelova J., Otsuka K., Bakken E.E. Harm vs. benefit from losartan with hydrochlorothiazide at different circadian times in MESOR-hypertension or CHAT. In: Halberg F, Kenner T, Fiser B, Siegelova J. (Eds.) Proceedings, Noninvasive Methods in Cardiology, Brno, Czech Republic, October 4-7, 2008. p. 149-167.
7. [http://web.fnusa.cz/files/kfdr2008/sbornik\\_2008.pdf](http://web.fnusa.cz/files/kfdr2008/sbornik_2008.pdf)
8. Halberg F., Cornelissen G., Wilson D., Singh R.B., De Meester F., Watanabe Y., Otsuka K., Khalilov E. Chronobiology and chronomics: detecting and applying the cycles of nature. *Biologist* 2009; 56 (4): 209-214.

## **ZEOLITE-CONTAINING PRODUCTS OF “LITOVIT” SERIES RESEARCH OF SORPTION ACTIVITY**

**E.G. Novoselova**

*ZAO NPF NOV, Russia, Novosibirsk Closed Joint-Stock Company,  
Research and Production Company NOV, Novosibirsk, Russia, rio@litovit.info*

### **Section – Health Care: First Aid**

**Intoxication** is a special condition that may occur at any disorders and diseases with manifestations depending upon poisonous, toxic effects of different substances on the organism, as well as upon severity of the condition. However, intoxication is not limited only to such manifestations; it also results in serious dysfunctions of internals. Development of many diseases is accompanied with the specific condition that is medically called endogenous intoxication or endointoxication. If poisonous substances enter the body from the outside (with food, through skin, lungs and mucosa), this is called exogenous intoxication (or poisoning). Intoxication is a specific acute pathologic process that needs emergency medical aid. An outcome of intoxication usually depends on how promptly and efficiently medical aid is rendered to a patient. One of the ways to treat intoxications associated with environmental pollution and entering contaminants is

to regularly administer enterosorbents of natural origin based on zeolite that bind and remove toxins from the body. A large number of research studies focusing on sorption activity of the standard component of natural zeolite coming from the Kholinsky Field and derivative products of the “Litovit” series allow recommending them to be used for new directions of health care, including sorption therapy. These directions are becoming more and more important for solution of the global problem – human ecology. **Products of “Litovit” series provide a simple, readily available and at the same time efficient method for mono- and complex therapy and for prevention of environmentally induced conditions.** This paper presents some data from experimental in vitro studies of “Litovit–M”, data from preliminary animal studies, as well as clinical trials that allow estimating this product as enterosorbent. In vitro and in vivo studies aimed at sorption activity of “Litovit – M” are conducted by the Research Institute of Pharmacology at the Tomsk Scientific Center of the Siberian Branch, Russian Academy of Medical Sciences. Based on the results of in vivo experiments aimed at research of “**Litovit – M**”, it is concluded that the product is **efficient in relation to alkaloids (atropines), barbiturates (ethaminals – sodium), tricyclic antidepressants (amitriptyline), in arsenical poisoning, poisoning with toxic metals (copper, barium, lead).** “Litovit–M” was investigated by in-vitro experiments in rats in order to confirm the obtained results. As a result of the completed studies, “Litovit –M” shows its efficiency as enterosorbent in relation to atropine, amitriptyline, digitoxin, as well as organophosphorous compounds. **It can be concluded from the data of these experimental studies that “Litovit – M” reduces degree of endogenous intoxication in relation to poisonous substances listed above in an efficient way. This confirms its sorption properties (see Tables below).**

Table 1

**Adsorbing activity of activated carbon and “Litovit–M”  
in relation to atropine in in-vitro experiments**

Adsorbent under study	Atropine concentration, mg/L		Adsorbing activity, mg/g
	Initial concentration	Concentration after contact with adsorbent	
Activated carbon	50.0	2.93 ± 0.17	11.77 ± 0.04
Litovit – M	50.0	13.77 ± 0.37	9.06 ± 0.09

Table 2

**Adsorbing activity of activated carbon and “Litovit–M” in relation to ethaminal – sodium in in-vitro experiments**

Adsorbent under study	Ethaminal – sodium concentration, mg/L		Adsorbing activity, mg/g
	Initial concentration	Concentration after contact with adsorbent	
Activated carbon	200.0	139.0 ± 4.0	3.8 ± 0.2
Litovit – M	200.0	128.0 ± 5.0	4.5 ± 0.3

Table 3

**Adsorbing activity of activated carbon and “Litovit-M” in relation to amitriptyline in in-vitro experiments**

Adsorbent under study	Amitriptyline concentration, mg/L		Adsorbing activity, mg/g
	Initial concentration	Concentration after contact with adsorbent	
Activated carbon	50.0	0.8 ± 0.5	12.30 ± 0.00
Litovit – M	50.0	2.0 ± 0.1	12.00 ± 0.03

Table 4

**Adsorbing activity of activated carbon and “Litovit-M” in relation to lead acetate in in-vitro experiments**

Adsorbent under study	Lead acetate concentration, g/L		Adsorbing activity, mg/g
	Initial concentration	Concentration after contact with adsorbent	
Activated carbon	1.0	0.689 ± 0.010	77.9 ± 2.7
Litovit – M	1.0	0.604 ± 0.030	99.0 ± 7.6

Due to anthropogenic factors and disasters, adaptation of the living organism to environmental effects is a very important problem that needs to be urgently addressed. Radiation exposure is one of the most serious factors. Not only consequences of nuclear

tests and accidents are a threat of radiation injury. **A constant, everyday problem** is landfilled and non-landfilled radioactive waste that results in buildup of radionuclides in plant and animal bodies, including human body. **Decontamination of different environments from radioactive substances, including detoxication of the human organism, has become one of the important problems in XX century and still remains the same in the XXI century.** Numerous experimental studies, including ones conducted by the Institute of Clinical and Experimental Lymphology at the Siberian Branch of the Russian Academy of Medical Sciences (ICEL, SB RAS), show that one of the most efficient methods to reduce specific radioactivity of body organs during excretion of cesium - 137 is “Litovit – M”. The sorption properties of “Litovit-M”, namely its efficiency for excretion of radioactive elements, was studied by the Institute of Experimental and Clinical Cardiology at the Siberian Branch of the Russian Academy of Medical Sciences in cooperation with employees of the Environmental Endocrinology Laboratory of the Research Clinical and Experimental Medicine at the Siberian Branch of the Russian Academy of Sciences, employees of the Novosibirsk State Medical Academy and employees of the Siberian Federal Healthy Nutrition Center.

#### **Results of the study show that:**

1. “Litovit–M” has the strongest radiation protection property as compared with other sorbents realized due to stimulated excretion of incorporated cesium, with more significant reduction in specific radioactivity of the liver and reduced development of destructive changes in the body.
2. “Litovit–M” reduces activity of destructive processes in liver against the background of a radiation injury and ensures a higher integrity of the liver as compared with other sorbents currently used.
3. “Litovit–M” stimulates plastic pH-potential of liver cells in case of a radiation injury and ensures faster rehabilitation of this organ.
4. “Litovit–M” allows efficiently reducing degree of endogenous intoxication in case of a radiation injury; due to this, it is reasonable to administer these products according to the recommended dosage after entering radionuclides in the body.

Therefore, “Litovit–M” contributes to extraction of toxic metabolites and radiotoxins from blood and *pericellular space, thereby ensuring maximum integrity of cellular structures, interrupting the cascade mechanism underlying the pathogenetic chain of stress disorders due to adaptable redistribution of activity of protection and compensatory systems at the stage of change in energetic and plastic reserve.* The experiment based on exposure of rats to radioactive cesium shows that animals kept on diet with addition of “Litovit–M” have demonstrated a more significant reduction of specific radioactivity of all organs that animals kept on other diets. In particular,

radioactivity of testicle and brain was, respectively, 40% and 28% lower as compared with animals kept on standard diet. **The experimental data conclusively demonstrate that “Litovit–M” stimulates excretion of radioactive cesium from the body in the most efficient way as compared with other sorbents.**

### **Clinical Studies**

**I.** Efficiency of “Litovit–M” as enterosorbent is confirmed by the report “Clinical Trial of Enterosorbent “Litovit–M” for Acute Intoxications“. The studies were conducted by the Moscow N.V. *Sklifosovsky Scientific Research Institute* of First Aid under the guidance of professor A.S. Ermolov, correspondent member of the Russian Academy of Medical Sciences. The clinical trials have shown that **“Litovit-M” can be administered for poisoning of any degrees, including poisoning with psychotropic drugs.** Administration of “Litovit – M” is accompanied with reduction of amitriptyline level in the stomach by 91%, leponex by 89% and finlepsin by 77% that demonstrates partial “capture” of toxicants and suggests that sorbent dose need to be increased by 9.11 and 23.0%, respectively. In case of poisoning with a mixture of toxic agents, a dose must be maximum, i.e. 100 grams. “Litovit – M” is well miscible with water; mixed with water, it forms a suspension that easily passes through a gastric tube. This facilitates administration of it in seriously ill patients. As compared with activated carbons, “Litovit – M” does not stain. Due to this advantage, it will find a wider area of application as compared with activated carbon.

#### **Conclusion: clinical trials of “Litovit – M” for acute intoxications show that:**

1. “Litovit – M” is an efficient enterosorbent that reduces concentration of psychotropic toxicants in the gastric contents by 77 – 91% and, in combined administration with the “basis therapy”, reduces concentration of toxicants in the blood by 65 – 90%.
2. “Litovit – M” is safe and well-tolerated by patients with acute diseases.
3. “Litovit – M” does not inferior to enterosorbent “Microsorb – P” in efficiency and even superior to it in several aspects.

**II.** Efficiency, tolerance and safety of “Litovit – M” in patients with occupational intoxication at combined use of “Litovit – M” with standard (basis) therapy of these diseases has been studied by the Clinic of Occupational Pathology of the Research Institute of Hygiene (Ministry of Health of Russia) that it is a clinical base of the Human Ecology Department, in cooperation with the Course of Occupational Diseases of the Novosibirsk State Medical Academy (Ministry of Health of Russia).

### Conclusion

Clinical trials allow making a general conclusion on efficiency of the enterosorbent “Litovit – M” as the pathogenetically substantiated component of etiotropic non-specific therapy for chronic occupational intoxications. **“Litovit – M” included in the standard therapy course contributes to improvement of functional condition of main barrier and detoxifying organs and systems, correction of primary pathogenetic toxicity mechanisms of industrial poisons.**

**III.** Efficiency of “Litovit – M” for excretion of heavy metals was studied in the clinical trial conducted by the Chelyabinsk State Medical Academy at the Ministry of Health of the Russian Federation. One of the most hazardous toxic substances is heavy metals. Therefore, it is a paramount task to excrete them from the body and, therefore, to eliminate the damaging action of heavy metals on the body.

The results of the studies are presented in the Table.

Table 5

#### **Content of toxic elements in the blood of patients under study at the 1st and 30th days of administration of the biologically active food supplement “Litovit-M”**

	<b>Cadmium (Cd)</b>	<b>Lead (Pb)</b>	<b>Copper (Cu)</b>	<b>Chrome (Cr)</b>	<b>Nickel (Ni)</b>
1st day	0.42 ± 0.06	9.4 ± 2.1	16.0 ± 1.1	8.9 ± 0.15	3.2 ± 0.08
30th day	0.2 ± 0.08	0.61 ± 0.12	7.65 ± 0.2	0.4 ± 0.02	0.62 ± 0.07
<b>The biologically active food supplement “Litovit-M” has shown the following efficiency as enterosorbent in relation to different elements:</b>					
	52.4%	93.5%	52.2%	95.5%	80.6%

The products of “Litovit” series are indicated not only for complex therapy (professional intoxications, intentional and unintentional poisoning with drugs, including psychotropic drugs etc.), but also as food supplement for compensation of inadequate adaptation syndrome (elimination of risks associated with adverse environmental effects on the organism). Preclinical and clinical studies conducted by different medical research and clinical institutes show that the products of Litovit series are not only safe, but also efficient products recommended as enterosorbents to different groups of population with different states of health, as well as for stress situations against the background of anthropogenic and natural disasters.

## **CLINOPTILOLITE-ZEOLITE AND MONTMORILLONITE MINERALS RICH IN SiO<sub>2</sub>: WHAT ARE THEY? WHAT CAN THEY ACHIEVE? WHY ARE THEY SO IMPORTANT FOR HUMAN HEALTH?**

**Karl Hecht,**  
*International Academy of Science H&E,  
Berlin, Germany*

A Survey of the Sanogenetic, Bioregulatory, Preventive,  
and Therapeutic Functions of these Original Minerals

### **1. The Patient is a “Black Box” to the Therapist**

The therapist assumes knowledge of the input into this black box, namely the active ingredient, but what happens to this substance inside the body he or she may suspect but does not know with any certainty. Numerous study results have shown that a pharmaceutical's effect may be strongly modified by numerous factors.

- Individuality
- Age
- Co-morbidity / multi-morbidity
- Sex
- Multi-medication (interactions)
- Nutro-pharmacological effects (interactions)
- Time of day (circadian rhythm)
- Environmental factors such as light, noise, harmful substances
- Body weight
- Dosing interval [10; 6; 26; 27; 47; 55; 37; 18; 16, 17].

“Dosing by the book, ‘one pill three times a day,’ is just as much a threat to patient safety as are contaminated physician's hands.” [48]. It is not hard to agree with this



statement. This results also from the issue of night-time supplies (during the sleeping hours) which is neglected in this approach. Other factors should be considered as well:

### **Our unnatural modern way of life:**

Lack of physical activity results in impaired circulation, and, therefore, in a reduction of the active ingredients' absorbability, rate of absorption, and transportability. Changes in the gastro-intestinal tract caused by improper nutrition, by the use of alcohol, nicotine, recreational and pharmaceutical drugs, result in pH changes, in a reduction of the absorption area and in various interactions. As a consequence of the neglect of these and similar factors medication errors occur, in particular in elderly patients. The Berlin study on pharmacotherapy in elderly patients [32] demonstrated this in a convincing manner, as shown in Table 1.

### **This is a sobering result**

Recently more and more papers have been published that take a critical look at the application of active ingredients, pointing out the many factors affecting it [e.g., 6; 26; 27; 32; 47; 55]. They are asking about active ingredient absorption, about their bioavailability and bioequivalence. Another question is that of "where" bioavailability is shown. In some cases, blood is considered an unrealistic compartment, and a determination of bioavailability in other tissues is recommended.

### **Therefore, the main unknowns for the therapist are:**

Active ingredient absorption (intestinal inflammation, changes in pH etc.)

Distribution across tissues and bioavailability and bioequivalence inside the body's cells Metabolisation, which may be affected by many interactions. Non-use of the active ingredient, dysregulation (adverse side effects, no effect) may be a consequence (see diagram in Fig. 1) Currently, there are attempts to express a healthy state in standard values and to consider deviations of these standard values as disease. These standard values are considered "hard data." In hospitals and physician's offices they are treated as the "absolute truth" of medical diagnostics for distinguishing between a healthy and a diseased state. However, the limits set differ between countries or even between hospitals or change over time. As a student in medical school I was taught that the threshold value for hypertension was >160/90mmHg. Today, it has been lowered to 140/85mmHg

or even lower. These diagnostic parameters in medicine are statistic measures. They describe a non-existent average human organism. Declaring individual deviations of such values “abnormal” or “diseased,” therefore, is a matter of opinion, always open to erroneous diagnoses, for at least 5% of those examined. Defining disease is associated with even more uncertainty than the confusing and conflict generating defining of health. One would be hard pressed to find a generally valid and useful definition of 'disease' in relevant textbooks. The fragmentation of medicine into many subspecialties has lead to an inflation of definitions of disease. Efforts to heal diseases, therefore, are abstract. A therapist will be able to heal the diseased only if he or she does not aim solely to eliminate symptoms.

Back in his time, Rudolf Virchow [51] already had clear ideas about this when he pointed to the regulatory principle in the relationship between health and disease, postulating at a scientist convention at Innsbruck, Austria: “The known wonderful ability of the body to adapt, it is at the same time setting a measure of where the limit of the disease lies.

Table 1

**Medication in elderly patients [modified, based on Köppel 2003]**

Medication	70 to 84 year olds		85 years and older	
	Men	Women	Men	Women
Under medication	9.3 %	10.9 %	17.8 %	7.1 %
Over medication	15.5 %	12.4 %	20.9 %	15.5 %
Wrong medication	19.4 %	17.8 %	10.9 %	20.9 %
Correct medication	55.8 %	58.9 %	50.4 %	46.5 %
At least 5 findings of adverse effects in one patient	15.5 %	22.5 %	31.0 %	30.2 %
Multiple medication > 5 drugs	34.1 %	39.5 %	42.6 %	35.7 %

Disease begins at the time at which the regulatory apparatus of the body no longer suffices to remove the disorder. It is not life under abnormal conditions as such that generates disease, but instead disease begins with the onset of

insufficiency of the regulatory apparatus.” [51]. Therefore, the existence of regulatory dynamics between being healthy and being sick has to be assume. Nobel prize winner I.P. Pavlov, a physiologist, had recognized this as early as 1885: At the conference of the Academy of Military Medicine in St. Petersburg in 1885 Pavlov stated that *"the unusual stimuli, that appear as pathogenic causes, at the same time also are triggers for the protective mechanisms of the organism that will take up the fight against these pathogens."* He considered all noxae pathogens.

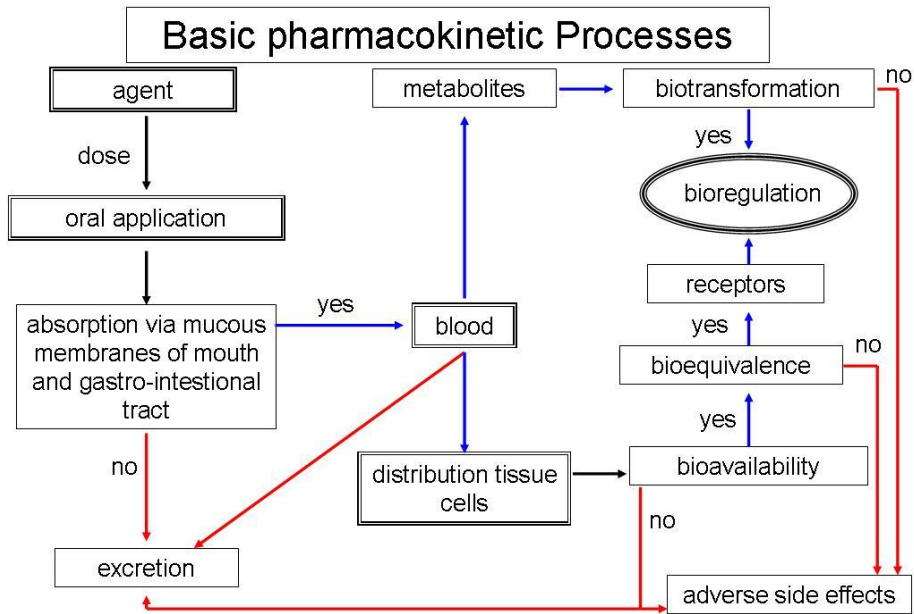
As Weiner [54], Hecht et al. [19], Pavlov [44], and Virchow [51] have already found, the border between health and disease is not an abrupt transitional function, but a instead a fluid transition that includes many “areas of gray”. This has been pointed out also by Ibn Sina, also known as Avicenna (980-1037). He classified six levels between health and disease.

### **1. Where does Health End and Disease Begin?**

Weiner [54] critically wrote:

“Diseases are terminological categories designed by man that are forced upon man. They may be appropriate in some cases, in others they are not.”

In any case, one has to distinguish between the healthy state, a pre-morbid state, an early state and a disease state [19]. Following Avicenna’s model, Hecht [21] and Anske [3] classified six different levels utilizing objective measurements as commonly employed in chronopsychobiologic regulatory diagnostics [see 21, 22 for a review]: Very healthy, healthy, still healthy (pre-morbid phase), no longer healthy (early state), sick and very sick. Referring to the above mentioned hypotheses by I.P. Pavlov and R. Virchow, sanogenetic and pathogenetic processes are dynamically interacting in a regulatory manner. When interaction is dominated by sanogenetic processes, health states dominate; when the interaction is dominated by pathogenetic processes, diseased states of varying degrees occur. Pathogenesis is a commonly used term in medicine; it is focused in a one-sided manner on the occurrence and development of diseases. The concept of today’s medicine consists of reducing or eliminating pathologic symptoms. In order to do so, in most cases medication is used.



**Fig. 1. Diagram of the functional relationships of the basic pharmacokinetic processes** Such a diagnostically relevant gradual distinction between health and disease allows for differentiated therapeutic and effective prophylactic strategies in the sense of primary and secondary prevention.

These pharmaceutical drugs are non-physiologic and focused in a one-sided manner on specific effects, and, thus, are associated with many side effects. Lowering the blood pressure, e.g., by means of antihypertensives, a cure is not achieved, but instead a dubious elimination of one symptom that triggers new symptoms (e.g., sleeping disorders, dizziness, or fatigue) (see the packaging information for these drugs). In my opinion, this concept does not constitute an approach adequate for human physiology.

### 1. Treatment and Prophylaxis with Sanogenetic Stimulation

Sanogenesis is the entire process of self-regulation of becoming healthy (sanos = health). Hecht and Baumann [19] described sanogenesis as a complex auto-regulatory process that is used to stimulate functions of adaptation, protection, and self-healing. Sanogenesis is to be viewed as a holistic process, in which primarily the nervous system, the hormone system, the immune system, and the metabolic system, as well as the regulation of extracellular matrix and the healing and growth system are involved in the self-regulatory process [23]. The concept of sanogenesis is based on an approach of stimulation self-regulation and self-healing (e.g., the immune system) in order to make

sanogenetic processes dominant in the human body. Nobel prize winner and ‘jungle doctor’ Albert Schweitzer (1875-1965) also subscribed to this view of a physician's work. He put it as follows: “*We physicians do nothing but support and encourage the doctor who resides within the patient. Healing is self-healing.*”

## 2. How Are Sanogenetic Effects Triggered?

Any healthy, natural way of living and any realistic attitude towards the laws of nature, including those that govern humans, will stimulate sanogenesis. According to my experience, this includes the following elements of a healthy way of life: Exercise, a regular sleep-wake cycle with good quality sleep, dominance of positive emotions, proper rhythmic breathing, a balanced regime of activity and relaxation, sufficient intake of fluids, physiological diet without excesses, and, which is lacking in modern humans, an adequate intake of micronutrients, (e.g., minerals, vitamins, amino acids).

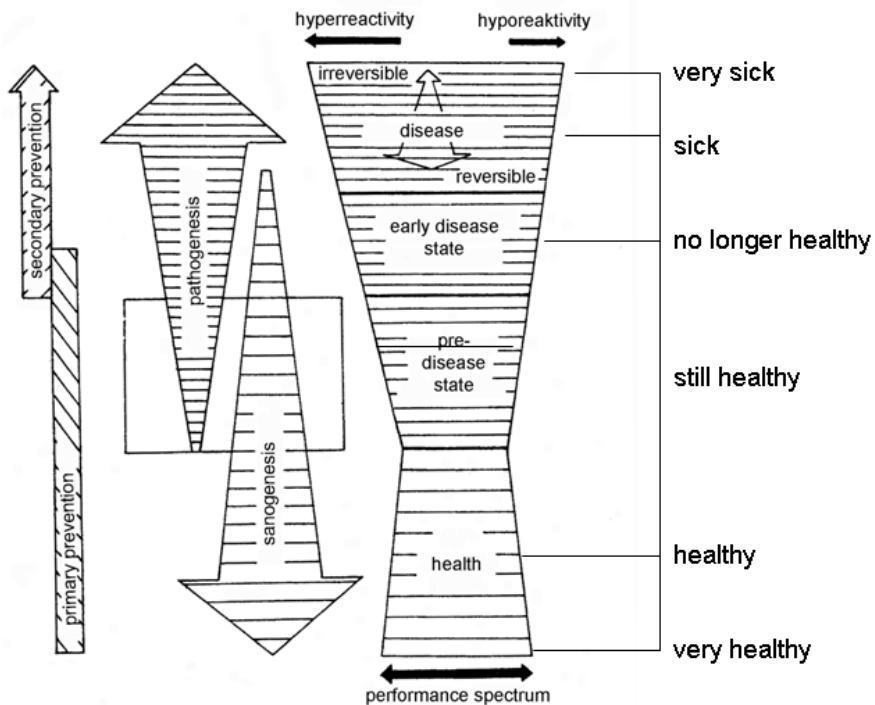


Fig. 2. Model of the relationship between health and disease [according to Hecht 1984]

Micronutrients may be counted among the sanogenetics, as long as they are applied in proper physiological relation to one another. This is emphasized in particular by Antonov et al. [4], who consider micronutrients, in particular minerals and vitamins, a main element of “nutrition hygiene.”

According to them, “nutrition hygiene” is the individually oriented guarantee of physiological functions of the entire metabolism, forming the basis for healthiness and performance.

The value of micronutrients is also emphasized by Kuklinski [35], in particular in the context of the treatment of frequently occurring nitrosative stress, because they re-balance the metabolic imbalance (in the sense of a sanogenetic effect). As previously stated, pharmaceutical drugs possess not the least of such characteristics as do micronutrients.

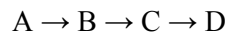
A special group among the sanogenetically effective micronutrients is that of the minerals. These are practically ignored by current medicine. In contrast, supermarkets supply people in an unqualified manner with inferior products. The application of minerals, however, belongs in the domain of responsible therapists who have a thorough knowledge of this matter.

### **3. Quantum Physical Hypothesis for the Substitution of Minerals**

Mineral substitution requires very particular knowledge of the physiology of mineral or electrolyte metabolism.

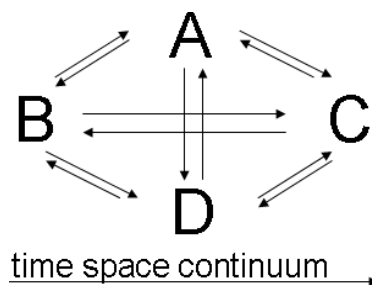
Assuming a linear causal chain of reactions for the regulation of electrolytes, as is the case with Newton’s hypothesis that is applied by conventional medicine, is unrealistic and non-physiological.

Schematic of Newton's hypothesis:



A highly organized multi-cellular organism can only function based on holistic systemic interactions, as shown in the quantum physical model:

Quantum physical hypothesis:



The processes of life take place throughout the space time continuum via the continuous formation and deconstruction of feedback loops. Our lives take place in a continuous functional transformation of creation and decay. For example, if you thought that you could compensate for a lack of calcium in the organism by substituting calcium, you would be wrong, because due to the biological transmutation of minerals inside the human body there are entirely different processes involved [30]. I will comment on this in detail later. Along the same lines, it is not fatty foods that cause obesity, but rather a surplus of carbohydrates [35; 25].

#### **4. No Life Processes without Minerals**

Minerals are integrated into all the processes of life as found in plants, animals, and humans. On the one hand, they form the basic substance of the structure, that is the skeleton of humans and animals, and on the other hand, they are involved in every regulatory process in the organism. There is not a single biochemical or biophysical process in an organism in which minerals are not involved. They practically form the inorganic substrate of life and are regulators of life. Minerals are present in the human body both in dissolved and solid states and have many functions, e.g., in regulating the extracellular matrix, as part of the acid-base balance, in osmolarity and voluminariness of body fluids. They are involved in the building of structural and hard substances as well as connective tissues, and are part of many functions, e.g., in the hormonal system, the lymphatic system, the enzymatic system, and the blood system. They also maintain the electrical activity of the cells, of the extracellular matrix, and of the tissues, and are essential for energy metabolism. Electrolytes are minerals that possess electrical conductivity because they dissociate into anions and cations. Electrolytes essentially are minerals in ion form. Cations are positively charged, anions are negatively charged. The electrolyte balance is understood to be the total metabolism of those ions dissolved in the body fluids. Examples of cations are  $\text{Na}^+$ ,  $\text{Ca}^{++}$ ,  $\text{Mg}^{++}$ . Examples of anions are  $\text{Cl}^-$ ,  $\text{HCO}_3^-$ . Ions are primarily found in the extracellular and intracellular fluids, where they may generate potential differences. It is in this electrolyte ion form that minerals fulfill the functions of electrophysiological regulation of the entire human organism. Therefore, a lack of minerals may not only result in a mineral imbalance, but may affect the electrophysical processes in their entirety and, thus, the total body homeostasis, because they are involved in so many functions.

**There are neither harmful nor beneficial minerals—there only are harmful and beneficial surpluses of them in the organism.**

This opinion is shared today by all of those studying the field of mineral metabolism and trace elements [46]. Using minerals in treatment and prophylaxis

requires a scientific and responsible approach. Therefore, when applying minerals in humans and animals, the following are to be taken into consideration:

Three levels have to be considered in the bioactive application of minerals:

Deficiency

Optimum

Toxicity [2].

As early as 1920 Bertrand pointed out, that in considering microelements and macroelements the following were important:

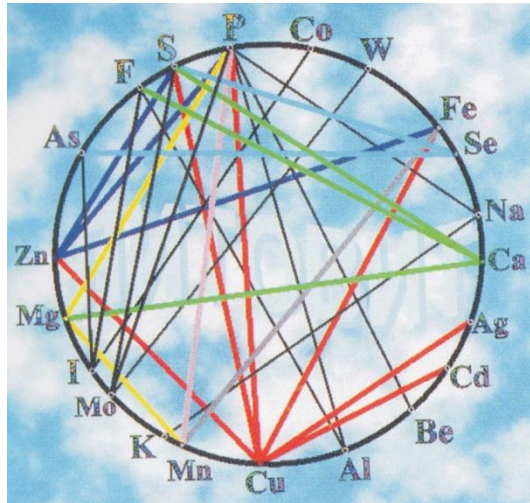
When there is an absolute deficiency, death will occur, if the supply of an organism with minerals is limited, the organism may survive but will experience a borderline deficiency state, if there is a surplus of one or more elements, a state of "marginal toxicity" will occur, which eventually may lead to "lethal toxicity." The systemic regulatory principle in the processing of minerals applied to an organism is to be considered. **What is important is not to take large doses of one or another macroelement or trace element. Excessive intakes may even be harmful to one's health, causing shifts in the balance of one's mineral metabolism.**

## **5. Taking Regulatory Principles of Minerals into Account**

It is important to ensure proper ratios of minerals in the organism. Thus, systemic thinking and action is required when handling minerals. In addition, relevant knowledge of bio-regulatory mechanisms is necessary. According to Shalmina and Novoselov [41] the systemic interactions of various macroelements and trace elements inside the organism occur at different regulatory levels and in flexible antagonistic and synergistic interactions. It has been shown [46] that the co-enzyme function inherent in many minerals is subject to intersystemic and interaction-systemic principles.

In evaluating metabolic disorders, therefore, attention should primarily be paid to the systemic reactions of minerals. Absorption of applied minerals may, e.g., be influenced by the systemic levels of macro elements and trace elements present in the organism at the time of mineral application [5]. Because of the complex character of the functional synergistic and antagonistic relationships within the mineral metabolism, testing only for individual microelements and macroelements is actually inadequate and in contrast to the regulatory processes of the organism [38]. Based on the knowledge obtained thus far, Shalima and Novoselov [41], referring to Enslinger [13] described the following schematic model of the relationships of different elements of the mineral metabolism of an organism.





**Fig.3. Simplified diagram of the functional interactions of some minerals in the organism [according to Enslinger 1986 and Shalmina and Novoselov 2002]**

These interactions between individual elements show that if one of them is lacking or excessively present, a number of the others will be affected and the regulatory system may be "shaken."

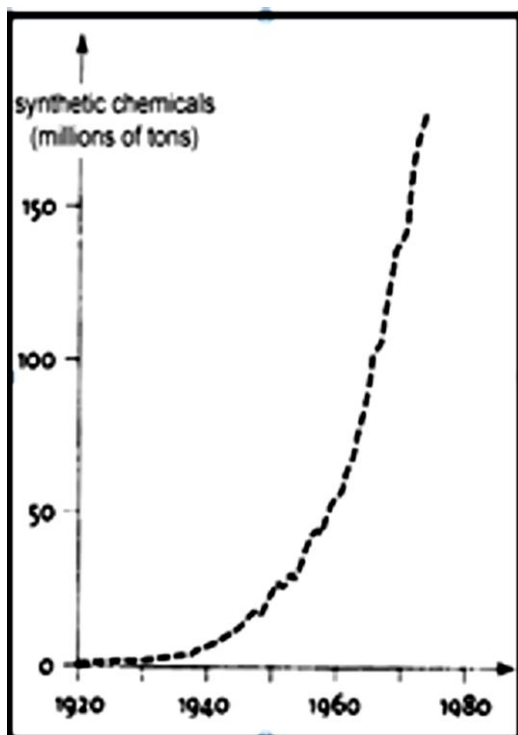
## **6. The World's Population is Suffering from Dismineralosis due to Environmental Pollution**

Current scientific opinion points to an alarming increase in the negative ecological burden of humankind. The natural metabolic cycles of the environment and of humans and animals continue to be impaired in a frightening manner, for example by pollutant burdens caused by environmental pollution, slow poisoning, manipulated food, in particular genetically engineered food, impairment of natural rhythms and the internal clock, increasing distress, abuse of pharmaceutical and recreational drugs, abuse of mineral intake, electronic smog, noise, and others.

The consequences: impaired health, immune deficiency, autoimmune disorder, tumor disorders, and other chronic disorders, depression, sleeping disorders, and others are on the rise [45]. Particularly affected is the elementary regulatory principle of the mineral metabolism, and, thus, the extracellular matrix. It is not the climate change that is the main hazard, but the environmental toxins. They endanger health and life of humans. The following example demonstrates this hazard:

### **Urine and Blood Studies by the European section of the World Wildlife Fund (WWF)**

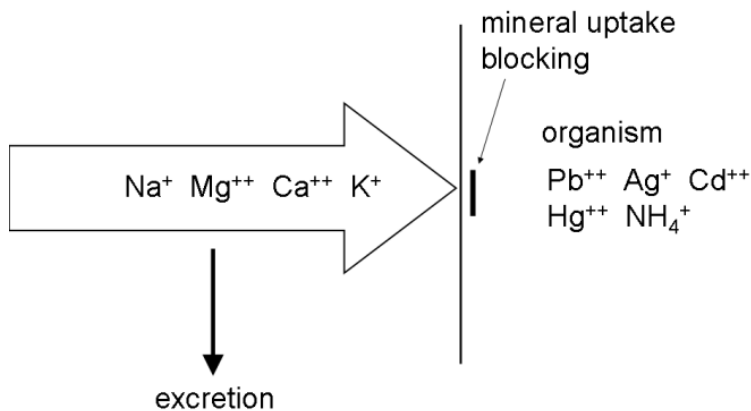
In 2004, tests done in 39 members of the European parliament and of 14 health departments of different European countries (a total of 53 individuals) found 13 chemical residue products of phthalates and perfluor compounds 25 pure chemical substances, of which were 1 x flame retardant, 2 x pesticides 22 x PCB (polychlorinated biphenyls) [58]. The production of synthetic chemicals, including pesticides, is an inflammation-stimulating novel phenomenon occurring increasingly since the middle of the 20th century [45]. These toxins may enter the human body along with food, air, pharmaceutical drugs, and liquids. Kaussner [29] lists the following examples: In fruits and vegetables, pesticide residues are frequently found. Animal meat contains nine times the amount of pesticides found in fruits and vegetables.



**Fig. 4. Worldwide production of synthetic chemicals [according to Servan-Schreiber 2008]**

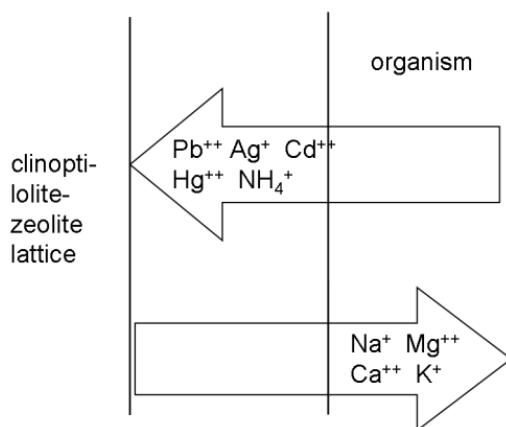
Worldwide, drinking water is burdened with nitrites, chlorine, herbicides, insecticides, fungicides, antibiotics, hormones from mass animal production, heavy metals etc., because it often is reprocessed from waste water. In the United States, this is supposed to be the case for 70% of all drinking water.

On the other hand, high-performance plant breeding results in a decrease of the mineral and vitamin content in fruits and vegetables of 50% every 25 years [29]. Novoselov [41] points out that the pollutant burden that almost all animals and humans experience today has not only made the systemic relationships within mineral homeostasis more complex, but also causes imbalances or systemic dysregulation (that often is chronic). The blocking of receptors with excess environmental toxins results in an impaired absorption of essential minerals



**Fig. 5. Dismineralosis schematic. The required minerals taken can not be absorbed by the organism and are excreted again [Hecht and Hecht-Savoley 2008]**

If minerals are to be applied, this excess of “pollutants” needs to be eliminated first. Otherwise, the applied minerals will have no effect or simply will be excreted again. Today, this is true for almost everybody.



**Fig. 6. Function state of the pollutant burdened human organism as re-established by ion exchange after the intake of natural clinoptilolite-zeolite [Hecht and Hecht-Savoiey 2008]**

Pollutants will be attracted by the crystal lattice of the zeolite via physical forces. The ions released in the lattice can bind to the organism's receptors and eliminate dismineralosis as well as oxidative stress. Zeolite also has radical scavenger capabilities. The crystal lattices fraught with pollutants are excreted with the stools.

## **7. Therapists Require Sanogenetics with Detoxification and Bioregulatory Functions**

Therapists should be aware of  $SiO_2$ -based bio-regulators such as zeolite, silica (silicic acid), bentonite, montmorillonite, and clays at least as "pharmaceutical auxiliaries". They have an "autopilot function" and are able, due to their specific characteristic, to balance to a certain degree the "usual" big unknowns of active ingredient effects.

What are the silicon rich natural minerals clinoptilolite-zeolite and montmorillonite capable of?

**Selective ion exchange:** Export of pollutant ions of all kinds, including radionuclides, and import of essential minerals.

**Adsorption:** In union with the ion exchange function the adsorption of pollutants, bacteria, and viruses, "detoxification of the body," 300-fold increase in uptake and bioavailability of minerals, vitamins, amino acids and other bio-regulators.

**Molecular sieving function:** Stabilization of the molecular sieve as a protective shield for cells in the extracellular matrix, thus regulating the metabolism.

**Hydration:** Due to the binding of water, a 400-fold increase in tissue function and tonus, in particular of the connective tissue, e.g. prevention of wrinkle formation.

**Protein synthesis** for building proteins.

Regulation of the acid-base balance (deacidification of the organism).

**Growth, healing:** Cell and tissue growth, cell and tissue repair.

Rhythm timing.

Protection of the electrolytic and electrophysiological processes with the semiconductor feature of silica (e.g., ECG, EEG).

Catalyst function for bio-molecular life processes [23].

### **What are clinoptilolite-zeolite and montmorillonite good for?**

- Detoxification of the body, removal of pollutants, capture of free radicals
- Increasing the stability of the immune system and resistance against diseases
- Controlling mineral metabolism
- Regulating functions of blood circulation, nervous system, and digestion
- Increasing mental and physical performance
- Inflammation inhibition, acceleration of healing
- Skin care
- Inhibition of the aging process
- Anti-bacterial and anti-viral effects
- Stress reducing effect
- Soothing, positive effect on sleep
- Optimizing the processing of important life substances
- Anti-fungal effects inside the body and on the skin
- Attenuation of side-effects of pharmaceuticals and other substances
- Attenuation of the effects of recreational drugs such as alcohol and caffeine
- Review by Hecht and Hecht-Savoley [23, 24].

### **8. SiO<sub>2</sub>-containing Minerals are Biogenically Imprinted**

The trail into the past leads us to silicon rich minerals and stones. They are holographically biogenically imprinted.

- SiO<sub>2</sub> (silicic acid)
- H<sub>4</sub>SiO<sub>4</sub> (colloidal silicon)
- natural clinoptilolite-zeolite
- montmorillonite
- clays and others

The **bio-geo-physico-chemical properties of action** of these active ingredients are similar to those of **the extracellular matrix** of humans and animals, because they are part of **its** own evolution [53; 9]. In numerous other studies it has been shown that silicic acid that forms in the presence of a certain organic compound will have a specific adsorptive capacity after this organic compound has been removed, that is valid for this particular compound.

This means, that in silicic acid ( $\text{SiO}_2$ ), other than in other natural inorganic substances, a memory has been formed [53; 1; 43].

This memory characteristic is assumed to be reflected by “imprints” or “matrices” that are left behind at the surface of the silicic acid ( $\text{SiO}_2$ ) by the molecules of the organic “sample” in the shape of their geometric molecular shape [7; 43; 15]. The idea that silicon is involved in gene expression and significantly so in DNA synthesis is shared by many scientists [59; 28; 52; 11]. Volcani [52] states that there are silicon dependent genes and that silicon is essential for the system of AMP cycles, ensuring AMP cycle replication. In this context the work by Oschilewski et al. [42] is to be mentioned, who found that silicon particles are capable of stimulating gene transactions via signals.

The scientific findings on the evolutionary biogenic testing of  $\text{SiO}_2$  and  $\text{SiO}_2$ -containing earths is also reflected in the teachings about the creation of man: “*And the LORD God formed man of the clay\* of the ground, and breathed into his nostrils the breath of life; and man became a living soul.*” [1. Moses, Genesis 2, 7 Old Testament]

\*: In some bibles it says dust.

**$\text{SiO}_2$  is the only mineral on our planet possessing biogenic properties.** As an aside, silicon in its various compounds is, after oxygen, the second most common element on our planet.

## **9. Silicon Containing Clays and Earths are Considered the Oldest Healing and Cosmetic Agents of Humankind**

### **Beauty and health with clay since thousands of years**

Clay minerals usually are hydrous aluminum silicates that may sorb water and ions. By sorbing water, clay may increase its volume by swelling. When clay is saturated with water it becomes impenetrable for water and air. Therefore, clay layers form important aquifers. Therefore, clay is also used for below ground grout curtains, e.g., in barrages and dams. Water that is in contact with clay layers usually contains mono silicic acid and colloidal silicic acid in solution (in varying amounts).

The role of silicon containing clay materials in the development of life on earth is postulated by numerous authors and also has been simulated in experiments. This

scientific idea is also reflected in the teachings about creation of various religions (Christianity, Islam).

*“And the LORD God formed man of the clay\* of the ground, and breathed into his nostrils the breath of life; and man became a living soul.”* [1. Moses, Genesis 2, 7 Old Testament]

\*: In some bibles it says dust.

Clay as a healing and cosmetic agent was already known in ancient Egypt, 3000 BC. The Egyptian queen Nefertiti (literally translated: The Beautiful One has arrived) is said to have maintained her beauty with facial masks made from clay. She washed her hair with basic clays and colored her lips with red clay [39]. In his book “Natural History”, Pliny the Elder writes about the healing properties of clay. He also reports that the dead were embalmed with clay in order to mummify them. This ancient report agrees with media information from 2003, in which it is said that in Swiss cemeteries on clay containing soils the interred bodies did not decompose and were recovered intact even after 60 to 80 years. Also from ancient Egypt originate reports on the antibacterial properties of clay that helped infected wounds heal faster and was used as a “natural sterilization agent” in the art of healing. According to the Apocrypha, Jesus of Nazareth is supposed to have used clay for healing, even helping blind people to see again. In ancient Greece, clay was used and referred to as healing earth. In particular the healing earth from the island of Lemnos was so popular that at times it was worth its weight in gold. Hippocrates (460-370 BC) gave young mothers healing earth from the island of Samos for the purpose of “internal cleansing.” Claudius Galenus (129 BC - 201 AD), the personal physician of Roman emperor Marc Aurel, mixed earth with water or wine and prescribed this mixture for the treatment of poisoning, fresh wounds, hemorrhoids, edema, diarrhea, and skin diseases.

In ancient times, antacids in the form of “finished earths” (Terra sigillata) played an important role. Of these, the “Lemnic earths” were particularly sought after. Back then, there was an Asclepian sacred place on the island of Lemnos. The priests there were at the same time healers who used “terra lemnic” as medicine, mainly to treat poisonings. It is said that Galen, guided by medical interests, even traveled to the island to learn more about its production and effects.

Ibn Sina/Avicenna (980-1037 AD) described in detail the treatment with gray-white clay in Canon Medicae, Vol. II (which dominated medical opinion for centuries) for the following conditions: wounds, ulcers, skin diseases, diarrhea, bladder conditions, “bloody cough,” and burns. He also described that he had been able to stop hemorrhaging during birth using it. For some formulations he mixed the clay with vinegar. Apparently, Avicenna already knew that SiO<sub>2</sub> (silicic acid) works best in a slightly acidic environment. In Arabia and Central Asia small cubes of clay, wrapped in

walnut tree leaves, continue to be sold for chewing. They are said to be effective for various diseases, primarily skin diseases and digestive disorders. About Adolf G. von Strümpel (1853-1925) it has been said that he stopped an outbreak of Asian cholera in East Prussia in 1903 by treating the disease with clay.

More recently, Julius Stumpf has described healing diarrhea, dysentery, and Asian cholera with Bolus alba (white clay), and the marine medical officer von Wilucki described the treatment of paratyphoid fever with Bolus alba in the journal *Münchener Medizinische Wochenschrift* (1914).

Treatment with blue clay and montmorillonite (gray-white clay) continues to play an important role in Russian popular medicine, e.g., for the treatment of osteoporosis and muscle pain. Prophylactic skin treatments with montmorillonite are used in conjunction with sauna or general grooming. In addition to increasing liveliness and tonus, these treatments are said to improve potency as well [39; 33, 34]. Nekrassova [39] reports about artists making sculptures from clay. They are supposed to live long and healthy lives. She recommends giving clay to children as a kind of play dough, to make figures with, because this may, with prolonged use, lead to strengthening of the immune system (as montmorillonite enters the blood stream through the skin). According to her, this toy would be much better for today's allergy-sensitive children than the commercially available toys made from plastics and metal. Sauna and spa centers of 5 star hotels in Berlin, Germany, offer facial masks and whole body treatments with clays from all five continents.

Today, silicon-containing clay types such as bentonite and montmorillonite continue to be used in naturopathy, as prophylactics and basic therapeutics. In addition, over the past 20 years, in alternative medicine the silicon-rich clinoptilolite-zeolite has proven a versatile active ingredient without side effects. Clay and clinoptilolite-zeolite currently are used for external treatments in compresses, but also in facial masks, mainly for chronic diseases, but also for beauty treatments. [23]

## **10. Clinoptilolite-zeolite and its Principles of Function**

Natural clinoptilolite-zeolite is a microporous tuff stone, an aluminum silicate with crystal lattice canals of 0.4 nm, filled with ions and crystal water. The crystal lattice of zeolite originated millions of years ago in volcanic lava earth and lava ashes expelled during eruptions and falling into the sea, combining with the colloidal, boiling sea water. Zeolite may contain all of the elements of the periodic table. Zeo is derived from the Greek 'zein' which means 'to boil.' lite is derived from the Greek 'litho', meaning stone. In 1756, zeolite was first described by the Swedish mineralogist Cronstedt. There are three forms of zeolite: **Phase-like, layered (flaky), and crystalline.** Clinoptilolite-zeolite

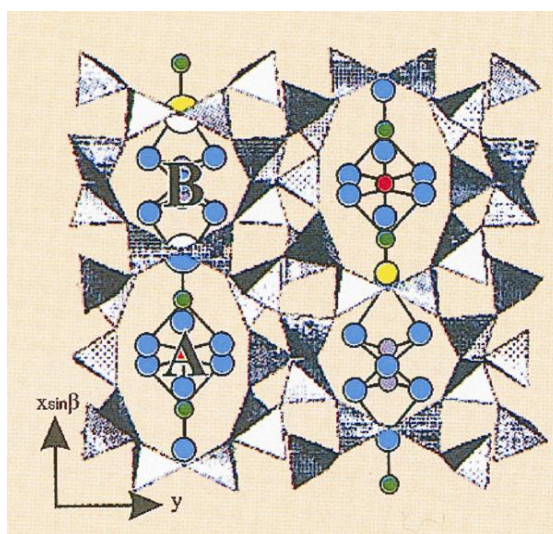


is one of the crystalline forms. The basic structure of clinoptilolite-zeolites is a crystal lattice with hollow spaces of about 4 Ångström (1 Ångström =  $10^{-10}$  m = 0,1 nm).

So far, in natural zeolites (clinoptilolites) at least 34 minerals have been detected. Frequently, they are present only in traces, as required by the living body of a highly evolved species. It is assumed that most elements of the periodic table are contained in zeolites. Solely clinoptilolite-zeolite is suitable for the treatment of humans and animals.

### Crystal Lattice of Zeolites

The lattice is formed by silicon ( $\text{SiO}_4$ ) and aluminum ( $\text{AlO}_4$ ) tetrahedrons. Inside these solid  $\text{SiO}_4$ - $\text{AlO}_4$ , network-like lattices, there are cations such as calcium, magnesium, sodium, potassium, and others, together with crystal water (no free  $\text{H}_2\text{O}$ ). Natural clinoptilolite-zeolite is characterized by high thermal stability and resistance to aggressive substances, in particular to acids and ionizing radiation. No harmful effects have been found in humans and animals when given in tolerable doses over the long term.



**Fig. 7. Zeolite lattice canals of various dimensions with different ions and labeled axes [according to Belitzkiy and Novoselov; Hecht and Hecht-Savoley 2008]**

## **Natural clinoptilolite-zeolite works as an auto-bio-regulator in human and animal organisms, with the hydrated SiO<sub>2</sub> playing the main role.**

### **Chemical Composition of Clinoptilolite-Zeolite of Various Zeolite Deposits**

The clinoptilolite-zeolite deposits on our planet do not all share an identical composition. A significant factor is the aluminum SiO<sub>2</sub> ratio. This should be at least a 1:4 ratio. Not every clinoptilolite-zeolite is suitable for medical purposes. Its suitability must be shown in corresponding data sheets.

### **On the Adsorption by SiO<sub>2</sub>**

SiO<sub>2</sub> is an adsorbent. Adsorbents are substances that are capable of binding dissolved, dispersed, or gaseous substances, and that may work inside the intestines by increasing their surfaces. This adsorption works to activate enzymes and their catalyst function. Bioactive substances such as SiO<sub>2</sub> or SiO<sub>2</sub>-containing natural minerals, but also other bio-regulators, may increase their effects by means of adsorption because they get closer to their field of activity. That way, the bioavailability of the active ingredients is increased. In this manner, SiO<sub>2</sub> ensures a safe bioequivalence.

Adsorption (from the Latin verb *adsorbere* = to bind to oneself)

Adsorption = Shift in the concentration of a substance near the interface of two adjoining phases

Positive adsorption → enrichment

Negative adsorption → displacement

In this context the term **absorption** needs to be mentioned as well. Absorption means the uptake of substances through the skin or mucous membranes into the blood or lymphatic streams. The terms absorption and adsorption must not be confused.

Physiologically, absorption is understood to describe the uptake of substances (nutrients, pharmaceuticals) through the skin or mucous membranes or from other tissues into the blood and lymphatic streams.

### **How Does the Adsorption Mechanism Work?**

As stated above, ground up zeolite may significantly increase the adsorptive surface area inside an organism. Zeolite adsorption is tied to body fluids. It is an interaction process between adsorbent and adsorbate that is established at the interface between body fluids and the surface of the adsorbent. Ion exchange and adsorption constitute a functional unit of action inside an organism. In elimination processes, e.g., of heavy metals, by means of ion exchange and adsorption, van der Waals attractions, physical adsorption (electrostatic interaction based on ion charges) and chemical

adsorption (synthesis of chemical compounds, e.g., between mineral ions and amino acids, peptides, and other molecules) play a role. The ion exchange is happening in that pollutants have a strong affinity for the clinoptilolite-zeolite lattices and that the cations present in the lattice are strongly attracted by organic substances in the organism.

Table 2

**Examples of the composition of various natural clinoptilolite-zeolites  
[Hecht and Hecht-Savoley 2008]**

<b>Kosiče Slovakia</b>	<b>Aidag Caucasus [Khalilov and Bagirov 2002]</b>	<b>Kholinsk Siberia [Veretenina et al. 2003]</b>
SiO <sub>2</sub> = 65.0-71.3 %	SiO <sub>2</sub> = 64.16 %	SiO <sub>2</sub> = 64.7-72.8 %
Al <sub>2</sub> O <sub>3</sub> = 11.5-13.1 %	Al <sub>2</sub> O <sub>3</sub> = 10.74 %	TiO <sub>2</sub> = 0.08-0.3 %
MgO = 0.6-1.2 %	Fe <sub>2</sub> O <sub>3</sub> = 1.26 %	Al <sub>2</sub> O <sub>3</sub> = 12.2-14 %
Na <sub>2</sub> O = 0.2-1.3 %	FeO = 0.27 %	Fe <sub>2</sub> O <sub>3</sub> = 1.4-2.7 %
CaO = 2.7-5.2 %	TiO <sub>2</sub> = 1.15 %	MnO = 0.03-0.4 %
TiO <sub>2</sub> = 0.1-0.3 %	CaO = 3.67 %	CaO = 1.5-3.8 %
K <sub>2</sub> O = 2.2-3.4 %	MgO = 2.17 %	MgO = 0.2-1.9 %
Fe <sub>2</sub> O <sub>3</sub> = 0.7-1.9 %	K <sub>2</sub> O = 1.38 %	K <sub>2</sub> O = 2.7-4.4 %
	Na <sub>2</sub> O = 2.52 %	Na <sub>2</sub> O = 0.8-3.0 %

Table 3

**Detoxification mechanisms of natural clinoptilolite-zeolite in various forms of  
Endotoxiosis of humans and animals [according to Shalmina and Novoselov 2002]**

<b>Endotoxiosis by</b>	<b>Mechanism of toxic substance elimination by natural clinoptilolite-zeolite</b>
Endotoxins, such as acidosis products, cytokines, bacterial endotoxins, free radicals, metabolic end products	Adsorption in the macropores and mesopores of natural clinoptilolite-zeolite
Exogenous toxins	Adsorption in the macropores and mesopores of natural clinoptilolite-zeolite
Lower molecular compounds such as NH <sub>3</sub> , H <sub>2</sub> O, Cd <sub>4</sub> , CH <sub>4</sub>	Adsorption in the macropores and mesopores of natural clinoptilolite-zeolite
Surplus levels of biogenic macroelements and microelements	Ion exchange
Heavy metals	Ion exchange
Radionuclides	Ion exchange

### Detoxification Function of Clinoptilolite-Zeolite

Based on scientific studies, Shalmina and Novoselov [46] have described in a very differentiated manner the detoxification mechanisms of natural clinoptilolite-zeolite that depend on the size of the pores and the ion exchange function, as shown in Table 3. Detoxification properties of natural clinoptilolite-zeolite are not only achieved by adsorption and ion exchange functions, but also by physical effects of the crystal surfaces of clinoptilolite-zeolite and  $\text{SiO}_2$ . (Crystal surface detoxification [40]) Release of Silica and Aluminum from the Natural Clinoptilolite-Zeolite Lattice in Human and Animal Bodies. Because of its high content of silicon tetrahedrons, natural clinoptilolite-zeolite is capable of participating in ion exchanges as well, namely of releasing  $\text{SiO}_2$  and forming colloidal  $\text{SiO}_2$ . As its environment becomes more acidic, e.g., because of the low pH in the stomach, even the fixed aluminum and silicon cations from the lattice may become involved in the adsorption ion exchange process.

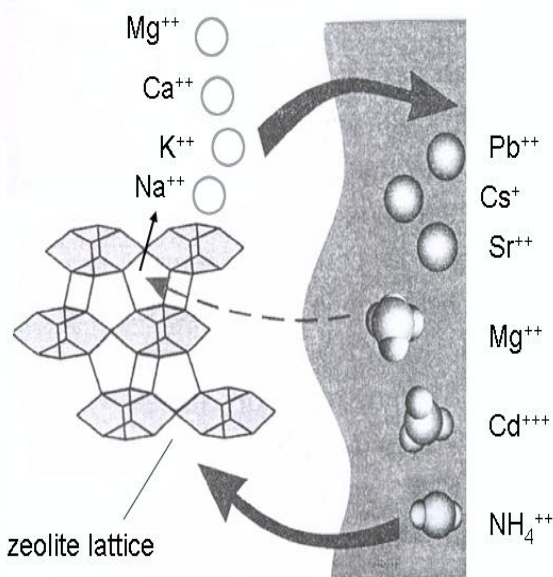
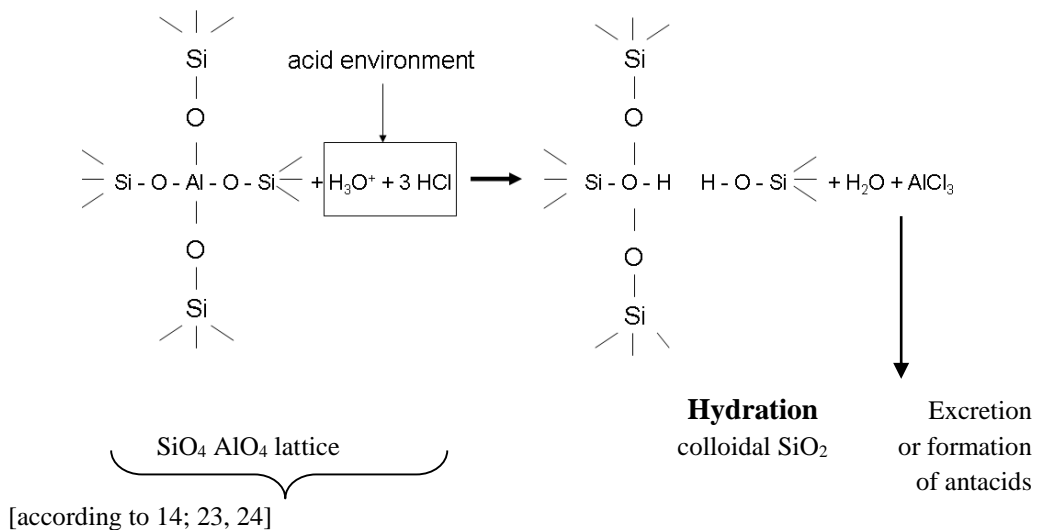
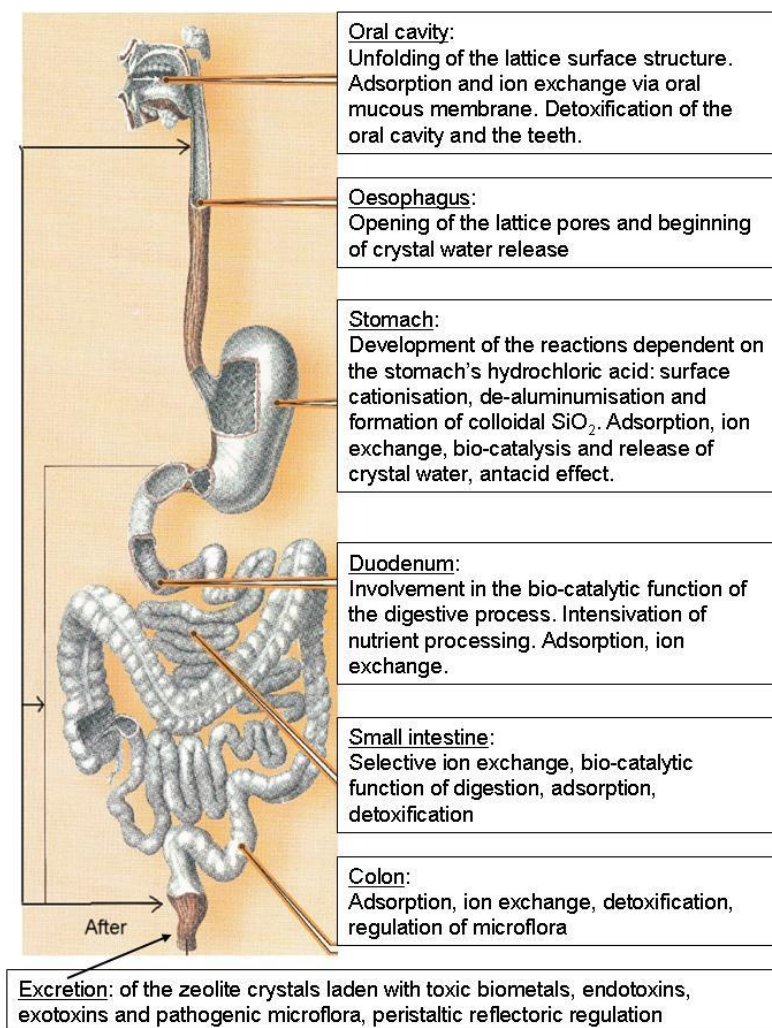


Fig. 8. Selective ion exchange, schematic [Hecht and Hecht-Savoley 2005, 2008]

In this process the  $\text{AlO}_4$  tetrahedron of aluminum is removed (neutralized) and replaced by  $\text{H}_2\text{O}^+$  ions in the hydrated form of the silicon tetrahedron. Gorokhov et al. [14] describe this process in a simplified manner by the following equation.

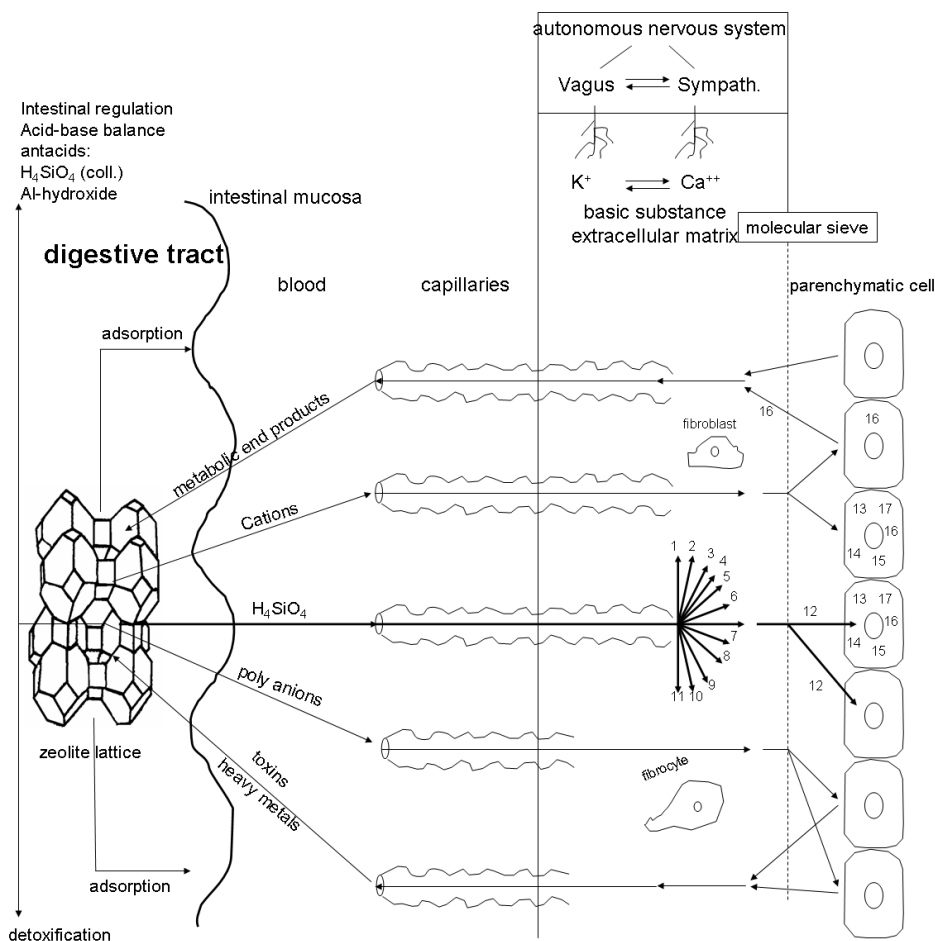


## Processing and effects of zeolites in the digestive tract



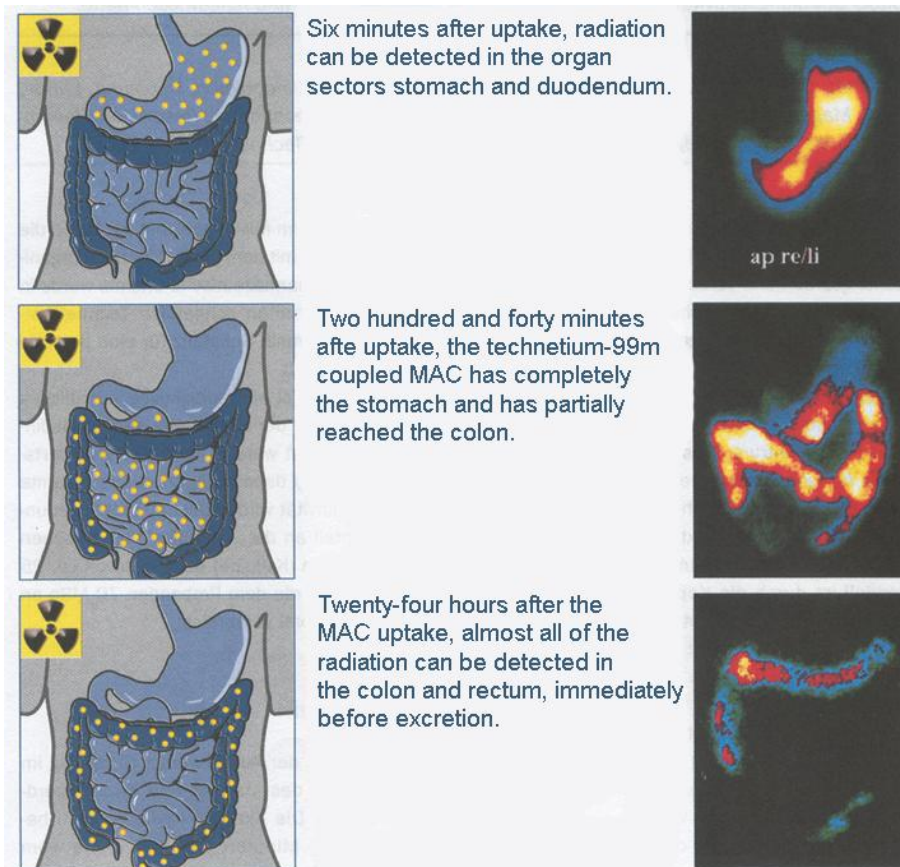
**Fig. 9.** [ modified according to Belizkiy and Novoselov 2006;  
Hecht and Hecht-Savoley 2008]

## 11. Principle of Function of Clinoptilolite-Zeolite in Human and Animal bodies



**Fig. 10. Simplified diagram: Processes inside the organism after oral application of clinoptilolite-zeolite and function of colloidal silicon ( $H_4SiO_4$ ) within the extracellular matrix, cell membrane, cell, and mitochondria [Hecht and Hecht-Savoley 2005, 2008]**

- |                                |                                |   |
|--------------------------------|--------------------------------|---|
| 1 catalyst function            | 6 growth, healing              | 13 intracellular matrix:respiratory chain → |
| 2 hydration                    | 7 unspecific immune function   | matrix:respiratory chain →                  |
| 3 adsorption                   | 8 electrostatic binding        | energy and information                      |
| 4 rhythm timing                | 9 colloidal phase              | exchange                                    |
| 5 protein synthesis, synthesis | 10 mineral homeostasis         | 14 respiratory chain →                      |
| of mucopolysaccharides,        | 11 acid-base homeostasis       | mitochondrial matrix →                      |
| collagen, glucosaminoglycanes, | 12 building, stabilizing,      | information exchange → ATP                  |
| fibronectines etc.             | protection, and repair of cell | mechanism                                   |
|                                | membranes                      | 15 gene regulation                          |
|                                |                                | 16 $Na \leftrightarrow K$ :intra- ↔         |
|                                |                                | extracellular matrix                        |
|                                |                                | 17 gene transaction                         |



**Fig. 1. Behavior of isotope labeled activated clinoptilolite-zeolite while passing through the gastro-intestinal tract [Daskaloff 2005, source froximun: excerpts of available research results, November 2006, p. 41-42]**

Natural clinoptilolite-zeolite is a natural donor and applicator of  $\text{SiO}_2$ . Taking clinoptilolite-zeolite and montmorillonite while also taking in sufficient amounts of fluids and exercising daily is sufficient to safely meet the  $\text{SiO}_2$  demand of the human body. This is in particular true for seniors wishing to stay young. Study of the absorption behavior of active clinoptilolite inside the human digestive tract by means of isotope labeling. Daskaloff [12] has confirmed by means of isotope labeling studies that clinoptilolite-zeolite is not absorbed in the human intestine, but rather is excreted.

“The study showed that activated clinoptilolite-zeolite (MAC) is not absorbed in the human intestines, but instead is excreted completely. The main residence time of MAC was measured in the gastro-intestinal tract, meaning that MAC is able to unfold its heavy metal and toxin adsorption potential here. In the study, the time between intake



and excretion was about 24 hours. Neither in the thyroid nor in the lungs nor in the kidneys was any radioactivity detected which would have pointed to clinoptilolite-zeolite absorption."

### References

1. Agronomov, A. E.; B. B. Patrikeev; A. P. Rudenko (1958): Vestnik MGU (ser. Mal, Mex., Fiz., Khim) No 3, p. 197. In: M. G. Voronkov; G. L. Zelchan; E. Lukevitz (1975): Silizium und Leben. Akademie-Verlag, Berlin
2. Anke, M.; S. Szentmihalyi (1986): Prinzipien der Spurenelementversorgung und des Spurenelementstoffwechsels beim Wiederkäuer. In: M. Anke; Chr. Brückner; H. Gürtler; M. Grün: Arbeitstagung Mengen- und Spurenelemente. Leipzig, p. 87-107
3. Anske, U. (2003): Chronopsychobiologische Pilotstudie zur objektiven Bestimmung funktioneller Gesundheitszustände. Dissertation, Medical School Charité of Humboldt University, Berlin
4. Antonov, A. R.; N. G. Mesenzeva; V. N. Mikheyev; Ja. B. Novoselov; A. G. Ronison (2007): Gesundheit durch Hygiene. Vol. 1 Hygiene der Ernährung. Novosibirsk, Sibirisches Zentrum für Gesunde Ernährung ISBN 5-85618-159-X, p. 1-81
5. Avzyn, A.P.; V.A. Shakhlamov; M.A. Rish; L.S. Stročkova (1991): Mikroelementosen des Menschen. Medicina, Moskau, p. 1-496
6. Basler, H.D. (2003): Komorbidität, Multimedikation und Beschwerden geriatrischer Schmerzpatienten. Med. Report **36/27**, p. 2
7. Becket, A. H.; P. J. Anderson (1960): In: Voronkov, M. G.; G. L. Zelchan; E. Lukevitz (1975): Silizium und Leben. Akademie-Verlag, Berlin, p. 12-52
8. Belizkiy I.A.; Ja. B. Novoselov (2006): Gegenwärtige Vorstellungen von der Wirkung des Mineralischen Nahrungsergänzungsmittels Litovit beim Menschen. Informationsposter der Wissenschaftlichen Produktionsgesellschaft NOV, Novosibirsk (russisch)
9. Blagitko, E.M.; F.T. Yashina (2000): Prophylaktische und therapeutische Eigenschaften des Naturzeoliths. Ekor, Novosibirsk, p. 1-158 (russisch) ISBN 5-85618-115-8
10. Brune, K. (2004): In der Evidenz-Falle. Deutsches Ärzteblatt **101/12**, S. C625
11. Cairns-Smith A. G. (1985): Bestanden die ersten Lebensformen aus Ton? Spektrum der Wissenschaft **8**, p. 82-91
12. Daskaloff, N. (2005): froximun: Verhalten von isotonenmarkiertem aktiviertem Klinoptilolith-Zeolith während des Durchgangs im Verdauungstrakt. Auszüge vorliegender Forschungsergebnisse, November 2006, p. 41-42
13. Enslinger (1986): In: Shalmina, G. G.; Ya B. Novoselov (2002): Sicherheit der Lebenstätigkeit. Ökologisch-geochemische und ökologisch-biochemische Grundlagen. Novosibirsk, p. 1-433 (russisch)
14. Gorokhov, W.K.; V. M. Duničev; O. A. Melnikov (1982): Zeolithe aus Sakhalin. Vladivostok, Dalnevostočnoe Knishnoe isdatelstvo, p. 1-105 (russisch)
15. Haldeman, R. G.; P. H. Emmett (1955): J. Phys. Chem. **59**, p. 1039

16. Hecht, K. (1963): The importance of individual excitability of the central nervous system in the investigation of centrally acting drugs. In: Votava, Z.; M. V. Horvath, O. Vinar (eds.): *Psychopharmacological Methods*, p. 219-230
17. Hecht, K. (1964): Die Bedeutung des zentralen motorischen Systems und des Aktivitätszustandes des ZNS beim "nichterlöschbaren" bedingten Fluchtreflex der Ratte. *Acta biol. med. germ.* **13**, p. 49-54
18. Hecht, K.; K. Treptow; T. Hecht; M. Poppei; S. Chavinovski (1968): Aspekte der Organismus-Umwelt-Beziehung in der Pharmakotherapie. *Dtsch. Ges. Wesen* **23**, p. 1777-1785
19. Hecht, K.; R. Baumann (1974): Stresssensibilität und Adaptation. *Belr. Ges. Inn. Med.* **8**, p. 673
20. Hecht, K. (1984): Dynamik der Wechselbeziehungen zwischen Gesundheit und Krankheit. In: M. M. Chanaschwili; K. Hecht: *Neurosen*. Akademie Verlag Berlin, p. 93-99
21. Hecht, K. (2001): Chronopsychobiologische Regulationsdiagnostik (CRD) zur Verifizierung von funktionellen Zuständen und Dysregulationen. In: K. Hecht; H.-P. Scherf; O. König (eds.): *Emotioneller Stress durch Überforderung und Unterforderung*. Schibri Verlag, Berlin, Milow, p. 193-252
22. Hecht, K.; St. Andler; St. Breinl; H.-J. Lander; M. Stück (2001): Objektive Kontrolle der Selbstentspannungsfähigkeit anhand von Zeitreihenmessungen des Blutdrucks und der Elektrodermalen Aktivität (EDA). In: K. Hecht; H.-P. Scherf; O. König (Hrsg.): *Emotioneller Stress durch Überforderung und Unterforderung*. Schibri Verlag, Berlin, Milow, p. 253-272
23. Hecht, K.; E. N. Hecht-Savoley (2005, 2007): *Naturmineralien, Regulation, Gesundheit*. Schibri-Verlag, Berlin, Milow, 1st and 2nd ed. ISBN 3-937895-05-1
24. Hecht, K.; E. Hecht-Savoley (2008): *Klinoptilolith-Zeolith - Siliziummineralien und Gesundheit*. Spurbuch Verlag, Baunach ISBN 987-3-88778-322-8
25. Heilmeyer, P. (2008): Die LOGI-Methode. *Ernährung und Medizin* **23**, p. 20-25
26. Hesselbarth, S. (2003): Arzneimittelinteraktionen in der Schmerztherapie von Alterspatienten. *Med. Repor* **41/27**, p. 6
27. Hiemke, C. (2003): Gibt es ein „therapeutisches Fenster“ für Psychopharmaka? *Med. Report* **41/27**, p. 6
28. Yakovlev, V.V. (1990): Der Bedarf an Silizium bei der Aufzucht von landwirtschaftlichen Jungtieren. Dissertation Universität Saransk, Russland, p. 1-21 (russisch)
29. Kaussner, E. (2001): *Kristallines Salz. Elixier der Jugend*. Evia-Verlag, Siegsdorf
30. Kervran, C.L. (1989): *Biologische Transmutation*. Autorisierte Übersetzung des englischen Werks (Deutsch von Helmut Lasarczyk). Nach der englischen Version von Michel Abehsera. 2nd ed., Happiness Press P. O. Box DD Magalia California 95954 ISDN 0-916508-47-1
31. Khalilov, E. N.; R. A. Bagirov (2002): *Natural Zeolites, their Properties, Production and Application*. International Academy of Science Baku, ISBN 5 –8066.1006-4, p. 1-347 (russisch)

32. Köppel, C. (2003): Pharmakotherapie im Alter. *Berliner Ärzte* **11/2003**, p. 15-16
33. Kudryashova, N. I. (2000a): *Gesund durch Silizium*. Moskwa, Obras-Kompani (russisch)
34. Kudryashova, I. (2000b): *Behandlung mit Ton*. (russisch) Moskwa Oproz Kompanisdat., p. 1-94
35. Kuklinski, B. (2008): Praxisrelevanz des nitrosativen Stresses. 1. Mitteilung Diagnostik und Therapie neurologischer Erkrankungen. *OM u. Ernährung* **124**, p. F2-21, 2. Mitteilung: Therapie internistischer Erkrankungen. *OK u. Ernährung* **125**, p. F16-32
36. Laptev, V. Ya (2000): *Systemstörungen bei akuter Alkoholintoxikation*. Dissertation, Novosibirsk, p. 1-169 (russisch)
37. Mallmann, P. (2003): Wie viel Toxizität ist akzeptabel für wie viel Benefit? *Med. Review* **10** (2002), p. 13-15
38. Mayanskaya, N.N.; Ya. B. Novoselov (2000): *Sanogenetische Prinzipien von Mitteln, die auf der Grundlage von Naturmineralien hergestellt worden sind* (russisch). Ekor, Novosibirsk, p. 1-85 *Sanogenetičeskie prinzipy Bozdeystviya na organizm srestv na osnove prirodnikh mineralov*. ISBN 5-8518-092-5
39. Nekrassova, A. (2000): *Die Heilung durch Ton*. (russisch) Poliservis-M. Moskwa S., p. 1-118
40. Nikolajev, W.; D. Mayanskiy (1997): Zur Effektivität der neuen Nahrungsergänzungsmittel. *Sibirische Gesundheit heute* **6**, p. 1-3
41. Novoselov, Ya B. (2001): *Störungen des Stoffwechsels von Biometallen bei der akuten Alkoholintoxikation und Korrektur der Störungen durch Litovit*. Dissertation, Novosibirsk, p. 1-121 (russisch)
42. Oschilewski, U.; U. Kiesel; H. Kolb (1985): Administration of silica prevents diabetes in BB-rats. *Diabetes* **34**, p. 197-199
43. Patrikeev, B.B. (1958): *Spezifičeskoe formovanie povcikhnosley i katalitičeskiye prozessy*. Doctoral dissertation MGU, Moskwa (russisch)
44. Pawlow, I. P. (1885): *I n: Zukowveresnikow, I. M. (1952): Zurn vyss. nerv. dejatl.* **2/1**, p. 10-19
45. Sevan-Schreiber, D. (2008): *Das Antikrebsbuch*. Verlag Antje Kunstmann, München
46. Shalmina, G.G.; Ya B. Novoselov (2002): *Sicherheit der Lebenstätigkeit. Ökologisch-geochemische und ökologisch-biochemische Grundlagen*. Novosibirsk, p. 1-433 (russisch) *Blzonacmost shiznedeyatelnosti ekologo-geokhimičeskie i ekologo-biokhemiteskie osnovy*.
47. Sohn, W.; M. Sohn, F. Öri (2003): *Komorbidität und Multimedikation*. *Med. Report* **36/27**, p. 13
48. Stein, R. (2009): *Frauen und Arzneitherapie*. *Berliner Ärzte*, **4**, p. 14
49. Stumpf, J. (1914): *Bolus alba bei Diarrhöe, Ruhr und asiatischer Cholera*. *Münch. Med. Woch.* **40**
50. Veretenina, O.A.; N. V. Kostina; T. I. Novoselova; Ja. B. Novoselov; A. G. Roninson (2003): *Litovit*. Novosibirsk, Izdar (Verlag) Ekor, p. 1-103 (russisch) ISBN 5-85618-107-7

51. Virchow. R. (1868): Rede auf der Naturforscherversammlung 1869 in Innsbruck. In: K. Sudhoff (Hrsg.): Rudolf Virchow und die deutschen Naturforscherversammlungen. (1922) Akademische Verlagsgesellschaft, Leipzig, p. 93
52. Volcani, B.E. (1986): Diskussionsbeitrag Ciba Foundation Symposium 121: Silicon biochemistry. John Wiley u. Sons, Chichester, New York, Sydney, Toronto, Singapore, p. 110
53. Voronkov, M.G.; G.L. Zelchan; E. Lukevitz (1975): Silizium und Leben. Akademie-Verlag, Berlin
54. Weiner, H. (1990): Anwendung psychosomatischer Konzepte in der Psychiatrie. In: Th. von Uexküll: Psychosomatische Medizin. Urban Schwarzenberg, München, Wien, Baltimore, p. 920
55. Wiedmann, D. (2003): Einfluss des Geschlechts auf die Pharmakotherapie psychiatrischer Störungen. Med. Report **41/37**, p. 2
56. Von Wilucki (1914): Bolus alba bei Paratyphus. Münch. Med. Woch. **49**
57. WWF-France (Hg.) (2004): Planite. Attitude Sante, Paris
58. Yakimov, A.V. (1998): Wissenschaftliche Begründung und Perspektiven der Anwendung der Zeolith-enthaltenden Ergänzungen in der Viehzucht. Dissertation, Rasan. Russische Akademie der landwirtschaftlichen Wissenschaften. Wissenschaftliche Produktionsvereinigung „Niva Tatarstana“.

## **CHANGES IN SOME INDICATORS OF IMMUNE STATUS AFTER SLIT IN CHILDREN WITH RESPIRATORY ALLERGIES**

**Alakbarova N.Y.**

*Azerbaijan Medical University, Department of Allergy and Immunology,  
Baku, Azerbaijan, [ladynazile@yahoo.com](mailto:ladynazile@yahoo.com)*

### **Abstract**

In the article are presented the results of research of clinical-laboratory efficacy of sublingual SIT (SLIT) with standardized allergen extract of a mixture of house dust mites in children with respiratory allergies. Results of comparative analysis confirmed a statistically significant reduction in the intensity of clinical symptoms by 64.7% in children receiving SLIT compared with a group of patients treated with basic pharmacotherapy. Clinical efficacy of SLIT was accompanied by increased levels of cytokines in the blood serum, which indicates the impact SLIT on regulatory T cells that have the ability to adjust the response of T-helper cells and the I and II type by IL-10 production and (or) TGF $\beta$ .

## **Introduction**

Among respiratory diseases the bronchial asthma (BA) differs by the duration and severity of the chronic course of the disease. According to statistics, today BA affects about 235 million people in different age groups. /1/ According to WHO data, every decade the number of patients increases by one and a half times. Diagnostics and treatment of BA is a topical issue of modern medicine. Usually, for the treatment of BA used, symptomatic drugs are that relieve an attack and basic therapy drugs that affect the pathogenetic mechanism of the disease. Recently, specific immunotherapy (SIT), aimed at suppressing the pathological reaction of the immune system to allergens, has been effectively used for treatment. SIT is the only therapy that eliminates the cause of an allergic disease, reduces nasal, ocular and bronchial hyperactivity. Its essence consists in the introduction into the patient's body in increasing doses of the allergen that is the cause of the disease (pollen, house dust mites), which eventually leads to "addiction" of the immune system to a substance that could previously provoke an attack. Clinical therapeutic effect of SIT is achieved at the end of repeated 3-5 courses of treatment, and improvement can be observed even after the first course. By data from the website of scientific research institute of vaccines and serums of I.I. Mechnikov, remission after SIT lasts till 20 flyings, and 5% of patients in general forever get rid of an allergy. /2/

Lately in the treatment as a method of SIT effectively used sublingual immunotherapy (SLIT). These are characterized by a high safety profile and greater adherence to treatment, low risk of anaphylaxis. IgE is known to be a key factor in allergic response and triggers a hypersensitive reaction to the allergen. Numerous studies have revealed the prevalence of the Th2 type of the immune response, overproduction of IgE and an imbalance in the cytokine system in children with allergic diseases. Currently, it is known that the regulation of IgE synthesis is responsible for the subpopulations of Th-cells that secrete specific cytokines that affect B-cells of antibody producers. Cytokines, in particular gamma interferon, induce Th0 differentiation in the Th1 direction and inhibit Th2 cell formation. /3/ Recently, scientists have found out that SIT slows down the growth of IgE levels in the blood. With the development of medicine, it became clear that SIT affects not only IgE, but also other parts of the allergic reaction. SIT has an inhibitory effect on cellular and mediator components of allergic inflammation. Reduces recruitment and activation of mast cells and eosinophils, suppresses Th2 mediated inflammatory response, migration of effector cells into the centre of inflammation, cytokine and proliferative response to etiologically significant allergen.

Despite the great scientific achievements of recent years, the immunological mechanisms for the development of tolerance in the process of SLIT have so far been poorly studied and remain the subject of discussion. The aim of the study is to study the changes in immunological parameters after treatment SLIT with allergen extracts from a mixture of house dust mites in children with mild and moderate atopic bronchial asthma with concomitant allergic rhinitis.

### **Materials and methods**

The study involved 65 children with mild to moderate atopic bronchial asthma and allergic rhinitis, of whom 28 children received adequate basic therapy (Group 1). The other 20 children on the background of pharmacotherapy received SLIT by administering the drug "Staloral" with the subsequent evaluation of the efficacy of therapy (Group 2). The groups were comparable in severity of the disease. The age of the patients was from 6 to 10 years, 41 (63.1%) patients were diagnosed with mild asthma, and 24 (36.9%) with moderate asthma. The control group consisted of 18 healthy children of the same age. General clinical studies in patients with asthma were carried out by conventional methods. SLIT was carried out with standardised allergen extracts from a mixture of house dust mites.

The mixture consisted of *Dermatophagoides farinae* and *Dr. pteronyssinus* in equal proportions. In the composition of the drug Staloral "Allergen mites" used an allergen extract based on the patented culture Stalmite APF, developed by Stallergenes (France). The drug Staloral of mite allergen is intended for perennial therapy. The treatment protocol consists of two phases: the initial therapy phase (saturation phase) and the main treatment phase (maintenance therapy). Initial therapy begins with daily administration of the drug concentration of 10 IR/ml with one push on the dispenser and gradually increases the dosage up to 10 pushes per day. At the stage of maintenance therapy, the drug is administered at a concentration of 300 IR/ml. Recommended dosages are 4 pushes/day or 8 pushes 3 times a week. In the process of conducting the study, all the observed children receiving SLIT drug Staloral "Allergen mites", successfully finished the phase of a set of doses according to the scheme proposed by the manufacturer and continued to receive maintenance therapy (300 IR/ml) for 4 doses daily.

During the increasing phase of the SLIT, patients came once a week for intermediate visits to assess the correctness of allergen intake and treatment tolerability. Sublingual SIT was performed for 3 years. As an assessment of the effectiveness of the treatment were selected indicators of the dynamics of the severity of the main clinical symptoms. Rhinitis symptoms included nose

obstruction, rhinorrhea, sneezing. Symptoms of bronchial asthma include assessment attacks of breathlessness/shortness of breath and cough.

Laboratory monitoring was performed using the dynamics of changes in IgE, IgG4, IL-4, IL-10, IL-17, IFN- $\gamma$ , and growth factor transforming (TGF $\beta$ ) by immunoenzyme analysis (ELISA) method in accordance with the manufacturer's instructions. "DIAsource" test systems (Belgium) were used to quantify IL-4, IL-10, IL-17, IFN $\gamma$  and "eBioscience" (Austria) for IgE, IgG4 and TGF $\beta$  in blood serum. The optical density measurement was performed with the help of the "STAT FAX 303 PLUS" immunoenzyme apparatus (USA). Statistical processing of the results was carried out by the methods of parametric and nonparametric statistics. Statistical processing of the results was performed on a PC using a standard package of applied statistical analysis programs (Statistica for Windows v. 6.0). The critical confidence level of the null statistical hypothesis was assumed to be 0.05.

## **Results and discussion**

The effectiveness of SLIT was evaluated by us according to the dynamics of the degree of severity of the main clinical symptoms (cough, asthma attacks, nasal obstruction, rhinorrhea, sneezing). In our study, SLIT has a beneficial effect on the clinical course of respiratory allergopathology after the first course of treatment in 63% of children. In the course of SLIT, most of the clinical signs in the studied children with mild persistent asthma showed positive dynamics, while the clinical effect of treatment was observed 6 months after the beginning of treatment. Similar dynamics of clinical parameters was observed in the group of children with moderate asthma, who had clinical improvement after 12 months from the beginning of treatment.

The results of the comparative analysis confirmed a statistically significant decrease in the intensity of clinical symptoms by 64.7% in children receiving SLIT compared to the group of patients receiving basic pharmacotherapy. The decrease in the frequency and intensity of clinical symptoms was also accompanied by a decrease in the need for inhaled corticosteroids 12 months after the start of immunotherapy, and by the end of treatment, patients received only antihistamines.

On the contrary, in patients of the first group, receiving only medical treatment, there was an increase in the frequency and intensity of clinical manifestations, which was accompanied by an increase in the need for basic therapy drugs. It is known that different groups of cytokines are involved in the initiation of sensitization, regulation of development and implementation of allergic diseases.

In laboratory studies, the indicators of IgE, IgG4, IL-4, IL-10, IL-17, IFN- $\gamma$  and TGF- $\beta$  in patients of the study groups were compared with the mean values in healthy

children and indicators before treatment. The results of the studies in patients with atopic asthma, receiving only basic therapy, are presented in the table (table 1).

Table 1

**Content of IgE, IgG4 and some cytokines (IL-4, IL-10, IL-17, IFN- $\gamma$  and TGF $\beta$ ) in the blood serum of children receiving basic therapy in the dynamics of treatment (M $\pm$ m) (minimum-maximum)**

Indicators	Control group (n=8)	Mild BA (n=18)		Moderate BA (n=10)	
		Before treatment	After treatment	Before treatment	After treatment
IgE IU/mL	32,74 $\pm$ 6,5 (10,67-62,93)	79,17 $\pm$ 3,9* (59,16-119,16)	63,88 $\pm$ 1,8 (51,8-80,39)	205,18 $\pm$ 11,8* (170,84-285,29)	184,4 $\pm$ 14,2 (110,69-248,15)
IgG4 ng/ml	35,52 $\pm$ 8,8 (8,42-79,35)	14,92 $\pm$ 0,9* (9,69-24,67)	18,45 $\pm$ 0,8*^ (51,8-80,39)	6,71 $\pm$ 0,8* (2,58-10,85)	8,55 $\pm$ 1,0*^ (5,67-15,36)
IL-4, pg/ml	10,08 $\pm$ 0,8 (6,19-12,74)	12,47 $\pm$ 0,6 (6,74-16,36)	13,46 $\pm$ 0,4 (10,38-17,24)	11,18 $\pm$ 0,5 (9,24-13,74)	13,65 $\pm$ 0,4 (11,96-15,87)
IL-10, pg/ml	4,95 $\pm$ 0,8 (1,88-8,16)	3,48 $\pm$ 0,1 (2,81-4,39)	4,03 $\pm$ 0,1 (3,28-4,35)	2,61 $\pm$ 0,2* (1,62-3,28)	2,98 $\pm$ 0,2 (2,16-3,97)
IL-17, pg/ml	7,79 $\pm$ 1,2 (2,74-12,28)	15,13 $\pm$ 0,5* (10,84-17,92)	11,12 $\pm$ 0,5*^ (7,91-15,24)	13,43 $\pm$ 0,7* (8,64-15,92)	11,34 $\pm$ 0,6* (7,79-13,76)
IFN $\gamma$ , pg/ml	15,8 $\pm$ 1,3 (10,67-20,93)	10,78 $\pm$ 0,3* (8,26-13,46)	12,82 $\pm$ 0,4^ (9,68-16,28)	7,8 $\pm$ 0,6* (5,17-11,48)	9,89 $\pm$ 0,5^ (7,17-2,28)
TGF $\beta$ , ng/ml	28,48 $\pm$ 3,2 (17,69-43,37)	23,01 $\pm$ 1,8* (14,45-42,18)	31,91 $\pm$ 2,5^ (20,24-58,21)	4,8 $\pm$ 0,6* (2,47-8,67)	8,73 $\pm$ 1,0*^ (3,51-13,48)

**Note:** \* - in relation to the control group; ^ - in relation to the indicators before treatment (p<0,05)

As can be seen from the table in patients with a mild BA, the level of IgE in group 1 is 2.4 times (p<0,001) significantly increased in relation to control. At the same time, the level of IgG4 in patients with mild BA is 2.4 times significantly decreased in relation to control. Patients with moderate BA have the highest level of IgE, as its content in the 1st group



increases by 6.3 times ( $p < 0,001$ ) compared to the control. The IgG4 content, on the contrary, in the 1st group is 5.3 times ( $p < 0,001$ ) lower than the control values.

The analysis of the results of cytokine spectrum assessment revealed a natural decrease in IL-10, IFN- $\gamma$  and TGF- $\beta$  levels depending on the severity of bronchial asthma in the serum of patients. At the same time, it was found that the content of cytokines in the blood serum decreased more significantly as the severity of the disease worsened. In children with mild persistent bronchial asthma in the Group 1 before the beginning of treatment there was a tendency to decrease blood serum levels of IL-10, IFN- $\gamma$  and TGF- $\beta$ .

In the blood serum of children with moderate bronchial asthma, the concentration of the studied cytokines was lower than in patients with mild asthma, and there was a multidirectional change in the content of individual cytokines. In the group of patients with moderate BA the average content of IL-10, IFN- $\gamma$  and TGF- $\beta$  in blood serum decreases by 51,8%, ( $p < 0,01$ ) 2,0 times ( $p < 0,05$ ) and 5,9 times ( $p < 0,001$ ) in comparison with the control.

As can be seen from the obtained data, the level of IL-4 in patients with a mild BA is not statically significantly different from the control. At the same time, there is a significant increase in the concentration of IL-17 in the Group 1 by 94.2% ( $p < 0,05$ ) in relation to control. In patients with moderate BA in the Group 1 the content of IL-4 and IL-17 increases by 51.8% and 72.0%, ( $p < 0,05$ ) respectively, in comparison with the control. In this group of patients after the performed treatment basis the indicators of IgE, IgG4, IFN- $\gamma$ , IL-4, IL-10 and IL-17 were not statistically significant in relation to the data before treatment. After the basis of treatment in patients with moderate BA there was a statistically significant increase in the level of TGF- $\beta$  (by 81.9%;  $p < 0,01$ ) in relation to the data before treatment.

The positive effect of sublingual SIT on the course of respiratory allergopathology, in turn, was accompanied by a positive dynamics of laboratory parameters (table 2).

After the treatment, IgE levels were significantly reduced in patients with mild BA by 80.9%, and in patients with moderate BA by 2.1 times in relation to the indicators before treatment ( $p < 0,01$ ). There is an increase in IgG4 level in patients with mild BA by 2.9 times ( $p < 0,001$ ), and with medium BA - 4.6 times ( $p < 0,001$ ) in comparison with indicators before treatment.

After the end of SLIT treatment, there were significant changes in the cytokine status in the group of patients with both mild and moderate BA. In the group of patients with mild BA after treatment, the level of IL-4 decreases by 46.5%, IL-17 – by 46.3% in relation to the indicators before treatment. After treatment is observed a significant

increase in the level of IL-10, IFN- $\gamma$  and TGF- $\beta$ , respectively, by 56.0%, 36.1% and 3.4 times ( $p < 0,001$ ).

After SLIT, in the group of patients with moderate BA is observed in the level of IL-4 a decrease by 73.0% ( $p < 0,01$ ). In this group of children with moderate BA, the level of IL-10, IFN- $\gamma$  and TGF- $\beta$  in the blood serum increases by 92.9% ( $p < 0,001$ ), 37.5% and 3.2 times ( $p < 0,001$ ) in relation to the indicators before treatment.

Table 2

**Content of IgE, IgG4 and some cytokines (IL-4, IL-10, IL-17, IFN- $\gamma$  and TGF $\beta$ ) in the blood serum of children who received SLIT in the dynamics of treatment (M $\pm$ m) (minimum-maximum)**

Indicators	Control group (n=10)	Mild BA (n=14)		Moderate BA (n=6)	
		Before treatment	After treatment	Before treatment	After treatment
IgEIU/mL	32,74 $\pm$ 6,5 (10,67-62,93)	85,89 $\pm$ 3,8* (61,24-109,8)	47,49 $\pm$ 1,5* <sup>^</sup> (39,25-58,62)	189,61 $\pm$ 6,7* (176,65-218,34)	91,03 $\pm$ 6,8* <sup>^</sup> (75,48-117,62)
IgG4 ng/ml	35,52 $\pm$ 8,8 (8,42-79,35)	13,95 $\pm$ 1,3* (9,73-25,48)	39,89 $\pm$ 2,5 <sup>^</sup> (18,64-50,65)	8,23 $\pm$ 0,8* (5,21-10,35)	37,66 $\pm$ 1,6 <sup>^</sup> (33,28-37,57)
IL-4, pg/ml	10,08 $\pm$ 0,8 (6,19-12,74)	12,44 $\pm$ 0,2* (10,68-13,94)	8,49 $\pm$ 0,3 <sup>^</sup> (10,67-6,89)	16,3 $\pm$ 0,6* (14,12-17,94)	9,42 $\pm$ 0,8 <sup>^</sup> (5,65-10,74)
IL-10, pg/ml	4,95 $\pm$ 0,8 (1,88-8,16)	3,26 $\pm$ 0,2 (1,96-4,25)	5,09 $\pm$ 0,2* <sup>^</sup> (3,48-6,17)	2,27 $\pm$ 0,3* (0,97-3,17)	4,38 $\pm$ 0,3 <sup>^</sup> (3,36-5,29)
IL-17, pg/ml	7,79 $\pm$ 1,2 (2,74-12,28)	16,45 $\pm$ 0,7* (9,27-18,61)	10,16 $\pm$ 0,5* <sup>^</sup> (5,54-11,68)	12,23 $\pm$ 0,7* (9,57-14,26)	8,36 $\pm$ 0,9 <sup>^</sup> (5,16-10,58)
IFN $\gamma$ , pg/ml	15,8 $\pm$ 1,3 (10,67-20,93)	11,02 $\pm$ 0,6* (6,92-14,28)	15,97 $\pm$ 0,9 <sup>^</sup> (9,76-20,88)	8,00 $\pm$ 0,9* (4,67-10,17)	11,0 $\pm$ 0,9 <sup>^</sup> (8,18-14,28)
TGF $\beta$ , ng/ml	28,48 $\pm$ 3,2 (17,69-43,37)	19,6 $\pm$ 1,7* (9,58-31,19)	41,36 $\pm$ 2,7* <sup>^</sup> (21,16-56,18)	5,12 $\pm$ 0,5* (3,34-6,24)	17,53 $\pm$ 1,9* <sup>^</sup> (11,69-23,57)

**Note:** \* - in relation to the control group; <sup>^</sup> - in relation to the indicators before treatment ( $p < 0,05$ )

SLIT is known to affect regulatory T-cells that have the ability to regulate the response of T-helpers and type 1 and type 2 through the production of IL-10 and (or) TGF $\beta$ , improving the T-helpers' function and switching the response of type 2 T-helpers to type 1 T-helpers. /4, 5/ As can be seen from the results sublingual SIT also increases

the production of IL-10 T-regulatory cells. In SLIT, the allergen administered directly affects the intestinal immune system, stimulating the response of T-helpers type 3 and allergen-specific T-cell peptides, which improve T-regulatory function and increase the release of IL-10. This character of the changes confirms the current hypothesis about the important role of IL-10 in the development of the immune response in the course of SLIT, since this cytokine, suppressing the production of general and specific IgEs, leads to an increase in the synthesis of IgG4-antibodies. /4, 5, 6, 7/

IL-4 from Th2 cells induces both IgE and IgG<sub>4</sub> switching in B cells, while IL-10 inhibits IgE production but upregulates the secretion of IgG<sub>4</sub>, suggesting different ways of controlling IgE and IgG<sub>4</sub> production. /8/ The mechanisms of tolerance induction to allergens also remains unknown, but it has been proposed that exposure to some airborne allergens may favor immunological tolerance development via a modified Th2 response characterized by a high IgG<sub>4</sub>/IgE ratio. /9/

IL-17 induces the synthesis of a number of other cytokines, chemokines and prostaglandins by different cell types (fibroblasts, endothelial and epithelial cells, keratinocytes and macrophages).

This cytokine also induces respiratory remodeling, and increased chemokine expression attracts various cells, including neutrophils. There is evidence that the IL-4 is capable of inhibiting Th17 and the induction of IL-17 cells, a property of TGF- $\beta$  and IL-6 to initiate the differentiation of T cells into Th17 cells. Th17, may initiate chronic eosinophilic and/or neutrophilic inflammation in the nasal mucosa, bronchi, and development of allergic rhinitis and/or asthma. /10/

In the opinion of some authors, the IFN $\gamma$  level is increasing in allergic inflammation, which is aimed at restoring the balance between different populations of T-helpers, and in the opinion of others - at maintaining and strengthening the already developed allergic inflammation. /11/

At present, it has been established that TGF $\beta$  is a multifunctional indicator with a multidirectional action and has a pronounced immunoregulatory, antiproliferative, and regenerating effects. /12, 13/

It was shown that TGF $\beta$  inhibits the synthesis of proinflammatory cytokines and the secretion of certain immunoglobulins. /13/ SLIT leads to the increase of TGF $\beta$  in blood serum, which in turn affects the reduction of IgE production. To a greater or lesser extent, IL-10 and TGF $\beta$  have an effect on the reduction of IgE-dependent activation of mast cells, basophils, eosinophils, and production of cytokines by T-helpers type 2; they also have an effect on the respiratory tract, reducing the production of mucus by epithelial cells and their hyperreactivity. /5, 6, 7, 13/

In the results of the study it was revealed that after basic pharmacotherapy only the dynamics of cytokine changes was related only to TGF- $\beta$ , both in mild and moderate

BA. In contrast, in the group of children receiving SLIT, the significant changes after the treatment were related not only to TGF $\beta$ , but also to IgE, IgG4, IL-4, IL-10 and IL-17. Thus, in children with atopic bronchial asthma, the levels of IgE, IL-4, and IL-17 decreased significantly after the SLIT course, and the levels of IgG4, IL-10, IFN- $\gamma$ , and TGF- $\beta$  increased. In the group of children after the basic medical treatment only TGF $\beta$  level was significantly increased, and also low level of IFN- $\gamma$  was observed at mild bronchial asthma, IL-10 and IFN $\gamma$  - at moderate BA. The study proves the effectiveness of SLIT the immune status of children with ABA. The detected changes correspond to the change of profile of the T cell response towards Th1, which confirms the effectiveness SLIT on the pathogenetic level. The clinical effectiveness of the method and its "immunological justification" allow us to recommend sublingual SIT for wide application in pediatric practice.

### References

1. Астма. Всемирная организация здравоохранения. Дата обращения 27 сентября 2015
2. НИИ вакцин и сывороток им. И.И. Мечникова: Вопросы и ответы.
3. Новикова В.И., Новиков П.Д., Титова Н.Д. гетерогенность аллергии при бронхиальной астме у детей//Вестник Витебского государственного медицинского университета,2014,т.13, №4, с.110-116.
4. Cox L., Jacobsen L. Comparison of allergen immunotherapy practice patterns in United States and Europe. *Ann Allergy Asthma Immunol.* 2009; 103: 451–461
5. Deo S.S., Mistry K.J., Kakade A.M. Role played by Th2 type cytokines in IgE mediated allergy and asthma. *Lung India.* 2010; 27 (2): 66-71
6. Kim K.W., Lee K.E., Hong J.Y. Involvement of IL-10 gene promoter polymorphisms in the susceptibility for childhood asthma.*Lang.* 2011; 189:417-23.
7. Nie W., Fang Z., Li B., Xiu Q.Y. Interleukin-10 promoter polymorphisms and asthma risk: a meta-analysis. *Cytokine.* 2012; 60:849-55
8. Papadopoulos N.G. International consensus on (ICON) pediatric asthma. *Allergy.* 2012; 67: 976-997
9. Aalberse R.C., Stapel S.O., Schuurman J., Rispens T. Immunoglobulin G4: an odd antibody. *Clin. Exp. Allergy,* 2009, Vol. 39, pp. 469-477.
10. Просекова Е.В., Турянская А.И., Долгополов М.С. Семейство интерлейкина-17 при атопии и аллергических заболеваниях// Тихоокеанский медицинский журнал, 2018, №2, с.15-20
11. Гайдук И.М., Коростовцев Д.С., Шапорова Н.Л., Брейкин Д.В., Трусова О.В., Камаева И.А. 2013, Т. 15, № 1 Иммунологические показатели сублингвальной аллерген-специфической иммунотерапии у детей, с.51-54.
12. Корженевская К.В., Гавришева Н.А., Панов А.В., Сесь Т.П. и др. Трансформирующий фактор роста -  $\beta$ 1 при различном клиническом течении ишемической болезни сердца после операции коронарного шунтирования.

Медицинская иммунология. 2010; 12(6):521-528

13. Huiling L., Romieu I., Hao W. Genetic polymorphisms in transforming growth factor beta-1 (TGF $\beta$ ) and childhood asthma and atopy. *Am. J. Hum. Genet.* 2007; 121:529-38

## **DEPENDENCE OF MORPHOLOGICAL CHANGES IN THE GASTRIC MUCOSA IN PATIENTS WITH RHEUMATOID ARTHRITIS ON THE DURATION OF THE PATHOLOGIC PROCESS**

**<sup>1</sup>Musayev S.K., <sup>2</sup>Hadiyeva Sh.F.**

<sup>1</sup>*Gastroenterology-Rheumatology Department, Educational-Therapeutic Clinic,*

<sup>2</sup>*Azerbaijan Medical University, Baku*

**Key words:** rheumatoid arthritis, gastritis, mucosa

Rheumatoid arthritis (RA) – in addition to the defeat of the musculoskeletal system, has a significant systemic effect. In real clinical practice, a rheumatologist is faced with the task not only of treating the articular pathology, but also correction of the concomitant pathology that occurs against the background of the underlying disease. Lesions of the gastrointestinal tract is one of the main visceral pathologies arising in the background of RA [1].

Information about the frequency of gastrointestinal tract lesions in RA patients, which are available in the literature, fluctuate within large limits (13-70%). This difference can be explained by heterogeneous approaches to assessing the manifestations of pathological changes in the gastrointestinal tract and the depth of examination of patients [2, 3].

It was found that gastropathies were more often detected in women, the frequency of gastropathies increases with the age of patients. Also, with the duration of RA for more than eight years, an inconspicuous increase in the frequency of gastropathies was observed [3].

In the morphological study, some authors found of structural changes in the gastric mucosa (GM) in almost 100% of RA patients [4]. In all patients, pronounced infiltration of the gastric mucosa with plasma lymphoid cells, fibroblasts, and lymphocytes was observed. A direct correlation was found between the severity of morphofunctional changes in the stomach and the duration, severity and activity of RA.

**Objective:** To study the morphological changes in the gastric mucosa in patients with RA, depending on the duration of the disease. **Material and methods of the study:** The study was performed on the clinical base of Gastroenterology-Rheumatology Department of the Educational-Therapeutic Clinic, Azerbaijan Medical University. The study included 75 patients with RA diagnosis. The diagnosis was reliably established in accordance with 2010 ARA / EULAR classification criteria of RA, and also on the basis of clinical, radiological, immunological methods of investigation. Patients were divided into four groups: I group (n=12) – primary patients with a reliable diagnosis of RA, which was established at the time of the study; II group (n=31) – patients with the duration of the disease from one to five years; III group (n=19) – patients, with the duration of the disease from six to ten years; IV group (n=13) – patients with the duration of the disease of more than 10 years. All patients were in inpatient (hospital) treatment for active RA, and received various types of basic therapy in combination with NSAIDs and GCS. To detect the presence of morphological changes in the gastric mucosa, all patients underwent examination with the help of the esophago fibrogastroduodenoscope PENTAX EKP 1000 (Japan). In accordance with the objectives of the study, all patients in the course of fibrogastroduodenoscopy (EGD) to evaluate the morphological state of the GM were subjected to a targeted biopsy with the taking of multiple biopsy sample.

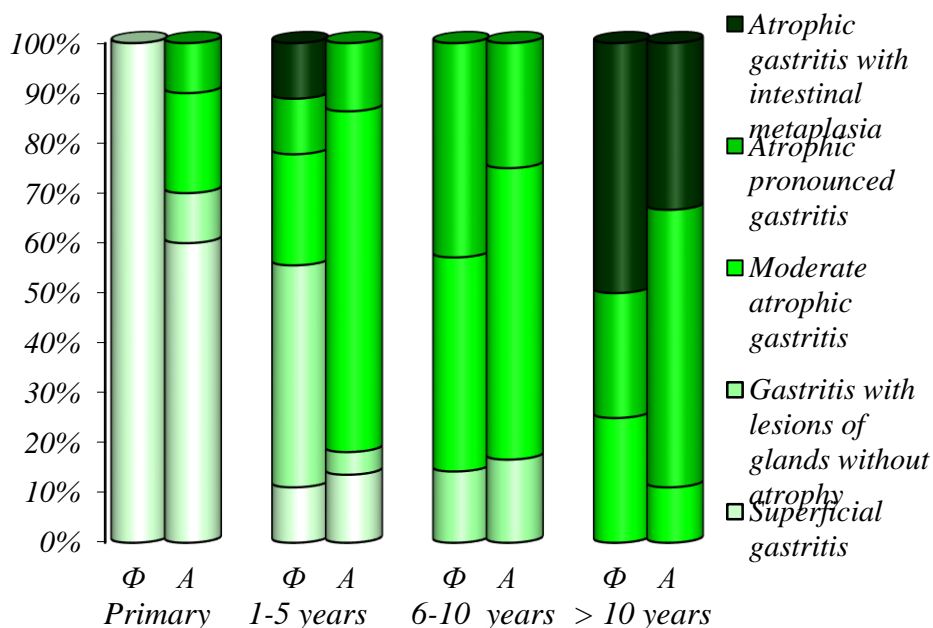
When evaluating the morphological changes was used a visual analogue scale to semiquantify the expressed inflammation, the stage of gastritis, the presence of atrophy, intestinal metaplasia. The following values were used as ranks: 0 – absence of signs, 1 – mild degree of signs, 2 – moderate degree of signs, 3 – marked degree of signs. Viewing and photographing of microscopic preparations were carried out on a microscope "Nikon Eclipse 50" (Japan) and a video analyzer "Nikon Digital Sight" mounted to it. To determine the degree of conjugation between the qualitative characteristics of the groups studied tetrachoric and polychoric analysis of  $\chi^2$ -Pearson was used. Results of the study: according to the morphological study, changes in the GM were revealed in all examined patients. In all 4 groups were diagnosed various morphological forms of chronic active and inactive gastritis, with and without atrophy, pathognomonic histological manifestations of which are: 1) vasculitis with characteristics of immune inflammation, 2) hyperplasia of lining's dimples and / or rollers+ stromal edema + abnormal appearance of smooth muscle cells (myocytes) around glands and dimples, in a stroma against a background of chronic lymphoid plasmacytic inflammation of mild and moderate intensity. It can be seen from the table that as the duration of the disease increases, GM is subjected to more serious lesions. For example, in primary patients, superficial gastritis occurs in  $66,7 \pm 13,6\%$  of cases, in the group of patients with the duration of the disease from one to five years, surface gastritis occurs in  $12,9 \pm 6,0\%$  ( $\chi^2=12,7$ ;  $p<0,05$ ). In the group of patients from six to ten

years old and over 10 years, the superficial form of gastritis does not occur. Moderate atrophic gastritis in the group of primary patients was 16,7±10,8%, and in the group of patients with the duration of the disease from one to five years – 54,8±8,9% ( $\chi^2=12,7$ ,  $p_1<0,05$ ). In the 6-10 age group, moderate atrophic gastritis occurs 52,6±11,5% ( $\chi^2=17,2$ ,  $p_1<0,001$ ). In the group of patients with the duration of the disease for more than 10 years – 15,4±10,0% ( $\chi^2=17,6$ ,  $p_1<0,01$ ), while atrophic *pronounced* gastritis in primary patients is found to be 8,3±8,0%, in the group of patients with the duration of the disease 6-10 years – 31,6±10,7% ( $\chi^2=17,2$ ,  $p_1<0,001$ ), in the group more than 10 years – 42,6±13,8% ( $\chi^2=17,6$ ,  $p_1<0,01$ ). Our study, atrophic gastritis with intestinal metaplasia was not observed in primary patients, but in the group of patients with the duration of the disease for more than 10 years it was found in 38,5±13,5% cases ( $\chi^2=17,6$ ,  $p_1<0,01$ ). When comparing these parameters with a group of patients with the duration of the disease from 1 to 5 years, where this form of gastritis occurred in 3,2±3,2% of cases, we obtained a significant difference ( $\chi^2=19,9$ ,  $p^2<0,001$ ). And when comparing these parameters with a group of patients with disease interval of 6-10 years, we also obtained a significant difference ( $\chi^2=12,7$ ,  $p_2<0,01$ ).

Table 1

**Morphological changes in the gastric mucosa depending on the duration of the disease**

Forms of gastritis	Duration of the disease			
	Primary n=12	1-5 years n=31	6-10 years n= 19	more 10 years n= 13
Superficial gastritis	8 66,7±13,6%	4 12,9±6,0%	–	–
Gastritis with lesions of glands without atrophy	1 8,3±8,0%	5 16,1±6,6%	3 15,8±8,4%	–
Moderate atrophic gastritis	2 16,7±10,8%	17 54,8±8,9%	10 52,6±11,5%	2 15,4±10,0%
Marked atrophic gastritis	1 8,3±8,0%	4 12,9 ±6,0%	6 31,6±10,7%	6 42,6±13,8%
Atrophic gastritis with intestinal metaplasia	–	1 3,2±3,2%	–	5 38,5±13,5%
$\chi^2$ p <sub>1</sub>		12,7 <0,05	17,2 <0,001	17,6 <0,01
$\chi^2$ p <sub>2</sub>			5,13 >0,05	19,9 <0,001
$\chi^2$ p <sub>3</sub>				12,7 <0,01



**Fig. 1. Frequency of occurrence of gastritis in various parts of the stomach**

This figure shows that in our study, lesions of the antral part of the stomach ( $70,6 \pm 5,3\%$ ) occur much more often than lesions of the basal part ( $29,3 \pm 5,3\%$ ), and in patients with the duration of the disease more than 10 years in the vast majority of cases occurs atrophic *pronounced* gastritis –  $38,5 \pm 13,5\%$  ( $\chi^2=9,77, p<0,05$ ). In our study atrophic gastritis with intestinal metaplasia occurred only in patients with the duration of the disease more than 10 years. And, as already noted above, the frequency of occurrence of lesions in the antral part of the stomach is higher ( $23,1 \pm 11,7\%$ ) than in the fundal part –  $15,4 \pm 10,0\%$ .

### Conclusions

1. Changes occurring in the gastric mucosa in patients with rheumatoid arthritis are positively correlated with the duration of the disease ( $r=0,64, p<0,01$ ).
2. With increasing duration of the disease more severe atrophic forms of gastritis occur more often. Thus, atrophic *pronounced* gastritis in primary patients is found to be  $8,3 \pm 8,0\%$  ( $\chi^2=17,6, p_1<0,01$ ), in the group of patients with the duration of the disease 6-10 years –  $31,6 \pm 10,7\%$  ( $\chi^2=19,9, p_2<0,001$ ), in the group more than 10 years –  $42,6 \pm 13,8\%$  ( $\chi^2=12,7, p_3<0,01$ ).
3. In our study, the lesions of the antral section ( $70,6 \pm 5,3\%$ ) of the stomach was observed more than the lesions of basal section ( $29,3\% \pm 5,3\%$ ). Atrophic *pronounced* gastritis of the antral part of the stomach was significantly more frequent in



patients with the duration of the disease more than 10 years ( $\chi^2=9,77$ ,  $p<0,05$ ).

### **References**

1. Каратаев А.Е., Насонов Е.Л. – Нестероидные противовоспалительные препараты и верхние отделы ЖКТ, патологии не связанные с развитием язв и эрозий // Рус. мед. журнал – 2002, N 8, с. 1318-1321.
2. Y. Kobata, K. Yajima, J. Yammao, et all - Risk factors for the development of gastric mucosal lesions in rheumatoid arthritis patients receiving long-term nonsteroidal anti-inflammatory drug therapy and the efficacy of Famotidine obtained from the forse study // *Mod. Rheumatol*, 2009, vol.19, N 6, pp. 629-636
3. Вязникова О.А. – Синдром диспепсии и патология верхних отделов желудочно-кишечного тракта у больных ревматоидным артритом: автореферат дис. на соискание ученой степени кан. мед. наук: спец. 14:00:05 – «Внутренние болезни» / Вязникова О.А. Нижний Новгород, 2008, 25 с.
4. T. Kurdova, N. Tanabe, D. Kobayashi, Y. Wada, M. Nakano et all – Association between clinical parametrs and amyloid – positive area in gastroduodenal biopsy in reactive amyloidosis associated with rheumatoid arthritis // *RheumatolInt*, 2012, N12, pp. 933-939

## **ELABORATION OF PHARMACEUTICAL MEANS ON THE BASIS LICORICE OF THE REPUBLIC OF AZERBAIJAN**

**<sup>1</sup>Veliyeva Mahbuba, <sup>2</sup>Veliyev Perviz**

<sup>1,2</sup>*Azerbaijan Medical University, Azerbaijan  
mahbubav\_amu@rambler.ru  
velperviz@yahoo.com*

The nature of Azerbaijan is rich and various. Along with surprising herbal flora and the fauna is diverse in addition with mineral rare objects. Therefore usage of domestic natural resources as medicinal raw materials for elaboration and creation of pharmaceutical production is important and relevant purpose in pharmacy and medicine.

Among the representatives of appointed flora using by the persons as remedies is difficult to find, perhaps, a plant with such ancient, documentary recorded history being possessed by Licorice (3). Licorice or liquorice – “Glycyrrhiza” is a natural officinal and technical plant. It was known for Sumer’s, Indians, Egyptians and being used as traditional medicine in ancient Chinese, Tibetan and Arabic medicine for a long time.

The medical book "*Yadzur — Veda*" being written in Sanskrit language (the science about life), being processed by doctor Sushrut, contains an information of Licorice root in the period of the 3rd century of our era. The Indian aesculapians added to the list of recommendations of Chinese doctors the treatment method of external inflammations and eye diseases. Approaches of Indian doctors have been generally accepted by the Tibetan medicine. Licorice root under the name of "shingar" was being registered in many prescriptions for treatment of pulmonary diseases and other respiratory diseases. The Licorice paid an attention the doctors of Greece, Rome, Burma where was delivered from China. By famous scientists such as Feofrast, Hippocrat, Pliny, Dioskorid the Licorice was included in one row with the most valuable curative plants (2).

Arabic intervention of the 6-8th century of our era also promoted for spreading of medical knowledge being accumulated since ancient times. The Licorice root began to be propagandized widely by the Arabic doctors as remedy. Ar-Razi was living in the 9-th century, wrote: "The licorice softens a pulmonary tube and cleans it, satisfies thirst, helps at inflammation of a stomach, is useful at burning urine, inflammation of kidneys and a bladder". Just Arabic doctors have concentrated a maximum of knowledge of curative plants and experience of treatment with them, have transferred the art to Europe of an era of crusades. Huge contribution for development of medicine in Europe was created by Avicenna (Ibn-Sina) which widely applied the licorice root for treatment of various diseases. Avicenna was the first which has found salutary influence of a root of Licorice in cases of liver diseases. The center of distribution of Arabic medicine experience was the medical school in Salerno. One of the first Europeans who have apprehended this knowledge was Konrad von Megenberg, the doctor of the 14th century. Thus, the Licorice has got in pharmacopeias of the majority of the countries in the world, and became a subject of attentive scientific research as remedy. Related with natural reserves and preparations of licorice root the former Soviet Union occupied leading place in the world. The botanical sort of Licorice "*Glycyrrhiza L*", families of bean (Fabaceae) in world flora is generally presented by about 15 types (according to the latest data to 33 (2)). The kind of plants "licorice" attracts an attention as a source of natural raw materials for receiving valuable medicinal, food, perfumery and cosmetology, technical and other products (1).

Since 1901 for 2018 period of time valuable medicines related with licorice root over 7360 world security sources of information in the form of patents have been received. The analysis of these security documents allows creating a conclusion of great potential advantages for Licorice in medical field. The special interest for preparations of licorice was shown in medicine, medicinal means obtained from licorice find the application not less than by 12 pharmako- therapeutic groups, and therefore

the application of licorice frequency has come out in medicine on top among floral herbs (3).

The licorice named by (*Glycyrrhizalaba L*) of a licorice smooth named by (*Liquiritiaoficinalis*) had been known as remedy in medical field more than 5000 years. Firstly, medical preparations were mentioned in the first book of herbs of China. The licorice root is a classical traditional medical means of Chinese and Tibetan doctors of medicine and being included in the "Gold Semerna" of the East. It is considered as a panacea of all diseases and also the means for saving of beauty and youth especially. By numerous scientific researches were being proved very useful medicinal properties of underground and elevated parts of a licorice. So, firstly in the world medical scientific practice are being revealed: limpnotrohic, immunotropic, also being studied anti-inflammatory, anesthetics, laxative, diuretic, antiallergenic, hepatotropic, wound healing, antibecheic, antimicrobial, antiviral, adaptogenic, antioxidant, antidotal, against narcotic, anthelminthic anti-parasitic, anticoagulants pharmako-therapeutic properties (1). At present, the licorice as a point of valuable source of natural crude attracts the general attention for obtaining of medicinal, perfumery cosmetology, food, technical and agricultural products. Refer to modern physical and chemical chromatographic methods of analysis in part of the licorice had been discovered about 200 biologically active components and basically of them are triterpenic components these are: glycyrrhizic acid and its derivatives, aglykon-glyceric acid and its derivatives, phenolic components: flavonoids and its derivatives, polysaccharides; pectins, pitches, sugar, amino acids and so on (1). Modern scientific research related with licorice is continued in several directions: expansion of a source of raw materials, allocation and division from made raw materials pharmacological of active agents and creation on the basis of original medicines; chemical and pharmacological modifications of being known medicines; creation of new "pro-preparations" on the basis of the known biologically active components. The Republic of Azerbaijan has huge stocks of Licorice roots. In the Republic of Azerbaijan 7 kinds of licorices grow, the most distribution was being gained by a licorice smooth or sweet. The sweet licorice of the Republic of Azerbaijan gained the global recognition among all known species of licorices; refer to high content of the main valuable component of glycyrrhizinic acid till 25% (4). Since 19-th century the sweet licorice of the Republic of Azerbaijan has been exporting for many countries of the world. In fact the new licorice industry has been organized by other way in Independent, Democratic and Civil Republic of Azerbaijan.

So, since 2005 year on the basis of deep scientifically based researches had been organized the open joint stock company with production of preparations of licorice- "Biyon Products" MMC which is located in Agdash district of the country. "Biyon Products" MMC has 1000 hectares of a newly created licorice plantations and

constructed plant with an area of 11 hectares. As a matter of fact that licorice industry takes the second place in the world after the American of the licorice industry "Licorice". The year raw materials of a licorice are gain grown up 3-years are being processed in the plant with receiving a reasonable root, dense extract, also preparations and medically biologically active additives in the form of syrups.

That plant has been working refer to exclusively newly developed standards and legal certificates. The special documents are the international patents and special certificates were being obtained from the Ministry of Health of the Republic of Azerbaijan: license for production, hygienic certifications, specifications, production schedules. The newly created licorice industry has a purpose for expansion of pharmaceutical, food, industry for color production, tobacco-growing, cosmetology production of construction materials, fertilizers of chemical household means and fodder products. Such big scale of planning is based on wide distribution of licorice in the territory of the country: the sweet licorice in the Republic of Azerbaijan is being widespreaded in Kura-Araks, Samur-Devechi, Primorsk, Mugan, Gobustan-Absheron, Alazan, Kurdamir, Ujar, Barda and Nakhchivan regions and also in the East Western direction of Great Caucasus and the central- southern parts of Lesser Caucasus.

The sweet licorice growing in the territory of the Republic of Azerbaijan as appointed before the medicinal and technical plant is most qualitative and rich in content of pharmacologically active components. Taking into account the scientific researches refer to chemical, technological, pharmacological-therapeutic studying of sweet licorice preparations and dietary biologically active supplements has been continuing from 1995 till 2018 years in the Azerbaijan Medical University. Scientists of many countries of the world had proved anti-inflammatory properties of licorice preparations, including glycyrrhizic acid and its derivatives, it is revealed that glycyrrhizic acid and its" saglicon enforcing influence of exogenous hormones of adrenal glands, inhibits oxidizing phosphorylation and biosynthesis of the sulfated mucopolysaccharides, creates lower an activity of a phospholipase A2, increases an activity of a glutaminyltransferase (6). It is shown, that glycyrrhizic acid inhibits activity of a phospholipase A2 in cellular membranes (7). Glycyrrhizic acid and its derivatives, like nonsteroid resolvers influence a cascade of arachidonic acid, inhibiting biosynthesis of prostaglandins. Taking into account phased out before, we have paid an attention for development of a number of medicinal and parapharmaceutical means on the basis of licorice related with anti-inflammatory activities; which were being certified in a form of patents: "the obtaining method of means from the herbal raw materials which are possessed by anti-inflammatory activity".

Eurasian Patent No. 028017 from 29.09.2017; «The means for prophylaxis and treatment of infectious and inflammatory diseases of a throat/throat and a mouth on the

basis of medicinal herbs". Eurasian Patent No. 027691 from 31.08.2017; «The method of glucyrram obtaining". Az. Patent p960014 from 08.05.1996; "The method of licorice dense extract obtaining". Az. Patent a2007 0851 from 08.11.2007; «The method of obtaining of extractive substances from herbal raw materials" Az. Patent a2007 0246 from 05.03.2007; "Licorice syrup with immunotropic activity".

Az. Patent a2007 0254 from 01.10.2007; "Anti-inflammatory and immunotropic" Az. Patent i2010 0112 from 12.05.2010; "Wound healing and antiburn means" Az. Patent i2013 0009 from 06.03.2013; "Remedy" of Az. Patent i2013 0008 from 06.03.2013.

Refer to these patents has been producing the "Biyan Products" MMC medical syrups by the name of: "Licorice syrup", "Licorice of Immunovit", "Licorice mute", "Licorice Cardio", "Licorice Bronco", "Licorice Gripson", "Licorice Uro", "Licorice Sed" created the worthy place in a pharmaceutical compounding. These syrups differ to high qualities refer to exclusive design and high pharmaco-therapeutic activity.

### **References**

1. Аммосов А.С., Литвиненко В.И., Попова Т.П. Солодка: применение в мировой практике обзор по материалам охранных документов за период с 1901 по 2018 гг.
2. [http://farmacomua.narod.ru/Licorice patent / acticle.html](http://farmacomua.narod.ru/Licorice%20patent/acticle.html)
3. Балтина Л.А., Шульц Э.Э., Толстиков Г.А., Покровский А.Г., Толстикова Т.Г. Солодка, биоразнообразие химия, применение в медицине, Новосибирск, 2007
4. Велиева М.Н. Солодка и ее применение в медицине (монография) Баку, 2012, 265с.
5. Велиев П.М. Эффективность применения иммунотропных препаратов солодки голой в комплексном лечении некоторых болезней у детей. Автореферат дисс. канд. мед. наук, Москва, 1996, 20с.
6. Вопросы изучения и использования солодки в СССР. М.; Л.: наука, 1966. 367с.
7. Kitagai A., Yano S., Takeuchi R., Nishino K., Asanima Y., Nanaboshi M., Yamamuga Y. // *Endocrinology*, 1964, V.74 (1). P. 145-149.
8. Tanqri K.K., Seth P.K., Parmar S.S. Bhargara K.P. // *Biochem. Pharmacol.* 1965., V.149 (5). P. 1277-1281

## **ABOUT BENEFICIAL FEATURES OF MEDICINAL PREPARATIONS OF LICORICE**

**Mahbuba Valiyeva**

*Azerbaijan Medical University, Baku, Azerbaijan  
E-mail.: mahbubav\_amu@rambler.ru*

Rational phytotechnological methods have been used to obtain a number of medicinal preparations from a natural national plant resource *Glycyrrhiza Glabra*, which approved regulatory documents in the form of patents and technological regulations. The firstly in the practice of world medical science, saponin-containing preparations of licorice naked were identified, allowing them to be widely used in medical practice for the treatment of oncological diseases, as well as diseases accompanied by a decrease in the Immune system. The scientific article presents the results of pharmaceutical and toxicopharmacological studies of medicinal preparations of the medicinal plant *Glycyrrhiza glabra* seu *Licoricae*. For the first time in the practice of world medical science, the lymphotropic properties of saponin-containing licorice compounds, obtained in the form of dry and dense aqueous extracts, as well as in the form of therapeutic syrups, have been identified and substantiated. Toxicological experiments proved their low toxicity and safety. On the basis of the obtained dense and dry aqueous extracts of *Glycyrrhiza glabra*, a number of drugs and medicinal biologically active additives were developed for the first time and received certificates in the form of National and Eurasian Patents. It has been shown that the developed therapeutic agents have anti-inflammatory, immunostimulating, antitussive, antihemorrhoidal, cardiotonic, antiviral, sedative, diuretic, antitumor activities, which allows them to be recommended for widespread medical use. Developed licorice-based medicinal syrups: “Licorice syrup”, “Licorice of Immunovit”, “Licorice Hem”, “Licorice Cardio”, “Licorice Broncho”, “Licorice Qripson”, “Licorice Uro”, “Licorice Sed” are produced by the national industry “Biyon Products LTD” and have been highly praised by buyers.

### **Introduction**

The nature of Azerbaijan is rich and various. Along with surprising herbal flora and the fauna is diverse in addition with mineral rare objects. Therefore, usage of domestic natural resources as medicinal raw materials for elaboration and creation of pharmaceutical production is important and relevant purpose in pharmacy and medicine.

Among the representatives of appointed flora, using by the persons as remedies is difficult to find, perhaps, a plant with such ancient, documentary recorded history being possessed by Licorice. Licorice or liquorice – “Glycyrrhiza” is a natural officinal and technical plant. It was known for Sumer’s, Indians, Egyptians and being used as traditional medicine in ancient Chinese, Tibetan and Arabic medicine for a long time. The medical book "Yadzur — Veda" being written in Sanskrit language (the science about life), being processed by doctor Sushrut, contains an information of Licorice root in the period of the 3rd century of our era.

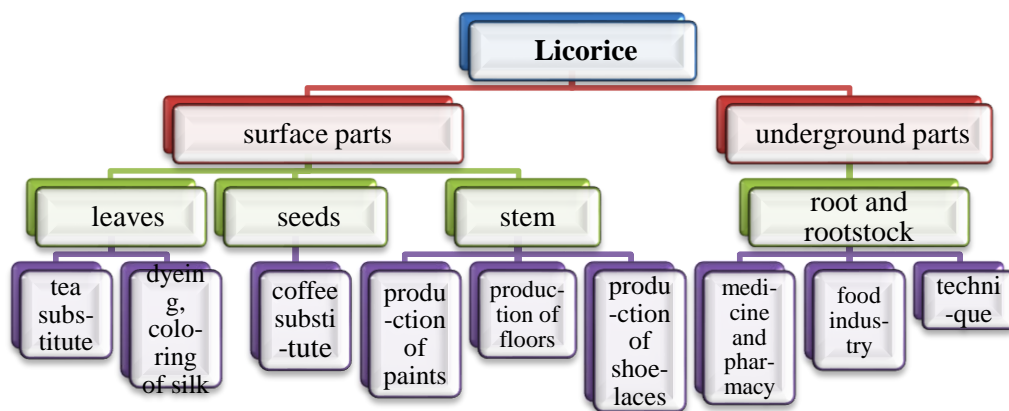
The Indian aesculapians added to the list of recommendations of Chinese doctors the treatment method of external inflammations and eye diseases. Approaches of Indian doctors have been generally accepted by the Tibetan medicine. Licorice root under the name of "shingar" was being registered in many prescriptions for treatment of pulmonary diseases and other respiratory diseases. The Licorice paid an attention the doctors of Greece, Rome, Burma where was delivered from China. By famous scientists such as Feofrast, Hippocrat, Pliny, Dioskorid the Licorice was included in one row with the most valuable curative plants. Arabic intervention of the 6-8th century of our era also promoted for spreading of medical knowledge being accumulated since ancient times. The Licorice root began to be propagandized widely by the Arabic doctors as remedy. Ar-Razi was living in the 9-th century, wrote: "The licorice softens a pulmonary tube and cleans it, satisfies thirst, helps at inflammation of a stomach, is useful at burning urine, inflammation of kidneys and a bladder". Just Arabic doctors have concentrated a maximum of knowledge of curative plants and experience of treatment with them, have transferred the art to Europe of an era of crusades. Huge contribution for development of medicine in Europe was created by Avicenna (Ibn-Sina) which widely applied the licorice root for treatment of various diseases. Avicenna was the first which has found salutary influence of a root of Licorice in cases of liver diseases. The center of distribution of Arabic medicine experience was the medical school in Salerno. One of the first Europeans who have apprehended this knowledge was Konrad von Megenberg, the doctor of the 14 th century. Thus, the Licorice has got in pharmacopeias of the majority of the countries in the world, and became a subject of attentive scientific research as remedy. Related with natural reserves and preparations of licorice root the former Soviet Union occupied leading place in the world. The botanical sort of Licorice “Glycyrrhiza L”, families of bean (Fabaceae) in world flora is generally presented by about 15 types (according to the latest data to 33 (2)). The kind of plants “licorice” attracts an attention as a source of natural raw materials for receiving valuable medicinal, food, perfumery and cosmetology, technical and other products (1). Since 1901 for 2018 period of time valuable medicines related with licorice root over 7360 world security sources of information in the form of patents have been received.

The analysis of these security documents allows creating a conclusion of great potential advantages for Licorice in medical field. The special interest for preparations of licorice was shown in medicine, medicinal means obtained from licorice find the application not less than by 12 pharmako- therapeutic groups, and therefore the application of licorice frequency has come out in medicine on top among floral herbs (3). The licorice named by (*Glycyrrhiza glabra* L. (F.)) or a licorice smooth named by (*Liquiritia officinalis*) had been known as remedy in medical field more than 5000 years. Firstly, medical preparations were mentioned in the first book of herbs of China. The licorice root is a classical traditional medical means of Chinese and Tibetan doctors of medicine and being included in the “Gold Semerna” of the East. It is considered as a panacea of all diseases and also the means for saving of beauty and youth especially. By numerous scientific researches were being proved very useful medicinal properties of underground and elevated parts of a licorice. So, firstly in the world medical scientific practice are being revealed: liotropic, immunotropic also being studied anti-inflammatory, anesthetics, laxative, diuretic, antiallergenic, hepatotropic, wound healing, antiechic, antimicrobial, antiviral, adaptogenic, antioxidant, antidotal, against narcotic, anthelmintic anti-parasitic, anticoagulants pharmako-therapeutic properties (1). At present, the licorice as a point of valuable source of natural crude attracts the general attention for obtaining of medicinal, perfumery cosmetology, food, technical and agricultural products. Refer to modern physical and chemical chromatographic methods of analysis in part of the licorice had been discovered about 200 biologically active components and basically of them are triterpenic components these are: glycyrrhizic acid and its derivatives, aglykon-glyceric acid and its derivatives, phenolic components: flavonoids and its derivatives, polysaccharides; pectins, pitches, sugar, amino acids and so on (3). Modern scientific research related with licorice is continued in several directions: expansion of a source of raw materials, allocation and division from made raw materials pharmacological of active agents and creation on the basis of original medicines; chemical and pharmacological modifications of being known medicines; creation of new "pro-preparations" on the basis of the known biologically active components. The Republic of Azerbaijan has huge stocks of Licorice roots. In the Republic of Azerbaijan 7 kinds of licorices grow, the most distribution was being gained by a licorice smooth or sweet. The sweet licorice of the Republic of Azerbaijan gained the global recognition among all known species of licorices; refer to high content of the main valuable component of glycyrrhizinic acid till 25% (4). Since 19-th century, the sweet licorice of the Republic of Azerbaijan has been exporting for many countries of the world. In fact the new licorice industry has been organized by other way in Independent, Democratic and Civil Republic of Azerbaijan. So, since 2005 year on the basis of deep scientifically based researches had been organized the open joint stock



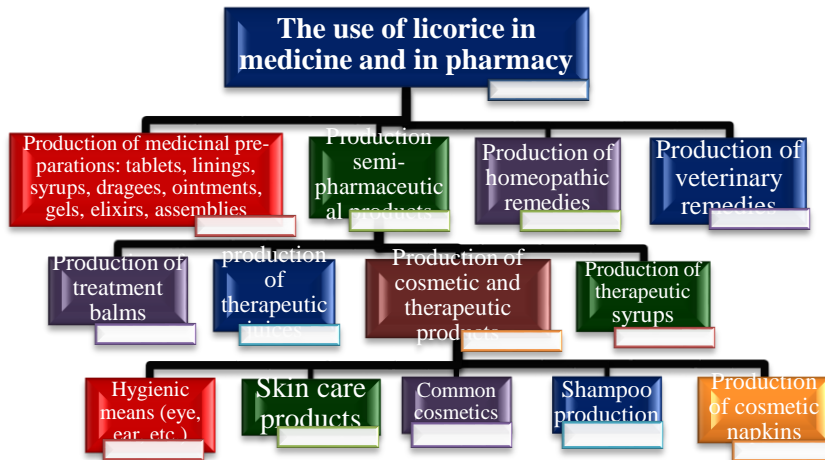
company with production of preparations of licorice-"Biyan Products" MMC which is located in Agdash district of the country. "Biyan Products" MMC has 1000 hectares of a newly created licorice plantations and constructed plant with an area of 11 hectares. As a matter of fact that licorice industry takes the second place in the world after the American of the licorice industry "Licorice".

Schema 1

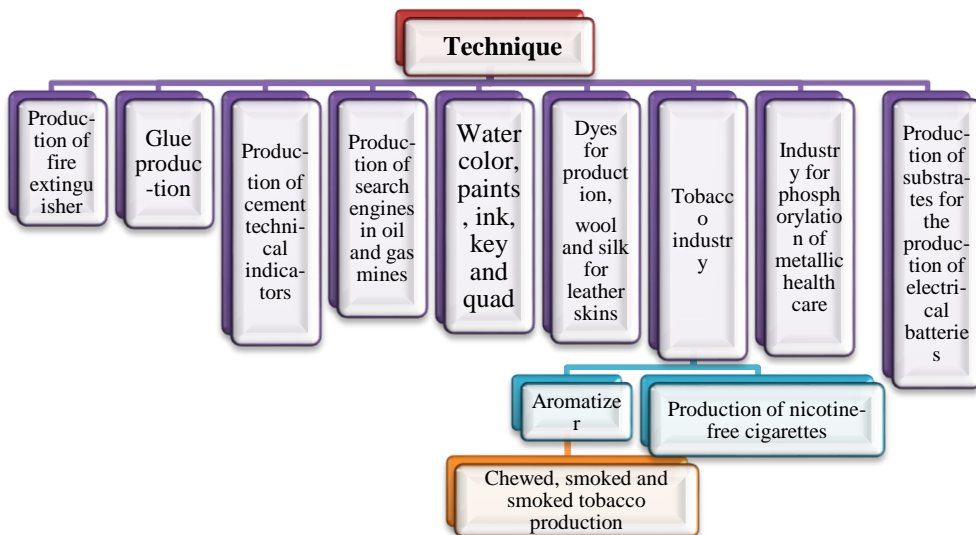


The year raw materials of a licorice are gain grown up 3-years are being processed in the plant with receiving a reasonable root, dense extract, also preparations and medically biologically active additives in the form of syrups. That plant has been working refer to exclusively newly developed standards and legal certificates. The special documents are the international patents and special certificates were being obtained from the Ministry of Health of the Republic of Azerbaijan: license for production, hygienic certifications, specifications, production schedules. The newly created licorice industry has a purpose for expansion of pharmaceutical, food, industry for color production, tobacco-growing, cosmetology production of construction materials, fertilizers of chemical household means and fodder products (schema-4).

Schema 2



Schema 3



Schema 4



Such big scale of planning is based on wide distribution of licorice in the territory of the country: the sweet licorice in the Republic of Azerbaijan is being widespreaded in Kura-Araks, Samur-Devechi, Primorsk, Mugan, Gobustan-Absheron, Alazan, Kurdamir, Ujar, Barda and Nakhchivan regions and also in the East Western direction of Great Caucasus and the central- southern parts of Lesser Caucasus. The sweet licorice growing in the territory of the Republic of Azerbaijan as appointed before the medicinal and technical plant is most qualitative and rich in content of pharmacologically active components. Taking into account the scientific researches refer to chemical, technological, pharmacological-therapeutic studying of sweet licorice preparations and dietary biologically active supplements has been continuing from 1995 till 2018 years in the Azerbaijan Medical University. Scientists of many countries of the world had proved anti-inflammatory properties of licorice preparations, including glycyrrhizinic acid and its derivatives, it is revealed that glycyrrhizic acid and it's aglicon enforcing influence of exogenous hormones of adrenal glands, inhibits oxidizing phosphorylation and biosynthesis of the sulfated mucopolysaccharides, creates lower an activity of a phosfolinaza A2, increases an activity of a glutaminiransfera (7). It is shown, that glycyrrhizic acid inhibits activity of a fosfolinaza A2 in cellular membranes (8). Glycyrrhizic acid and its derivatives, like nonsteroid resolvents influence a cascade of arakhidonic acid, inhibiting biosynthesis of prostaglandins. Taking into account phased out before, we have paid an attention for development of a number of medicinal and parapharmaceutical means on the basis of licorice related with anti-inflammatory activities; which were being certified in a form of patents: "the obtaining method of

means from the herbal raw materials which are possessed by anti-inflammatory activity".

Eurasian Patent No. 028017 from 29.09.2017; «The means for prophylaxis and treatment of infectious and inflammatory diseases of a throat/throat and a mouth on the basis of medicinal herbs". Eurasian Patent No. 027691 from 31.08.2017; «The method of glucyrram obtaining". Az. Patent p960014 from 08.05.1996; "The method of licorice dense extract obtaining". Az. Patent a2007 0851 from 08.11.2007; «The method of obtaining of extractive substances from herbal raw materials" Az. Patent a2007 0246 from 05.03.2007; "Licorice syrup with immunotropic activity". Az. Patent a2007 0254 from 01.10.2007; "Anti-inflammatory and immunotropic" Az. Patent i2010 0112 from 12.05.2010; "Wound healing and antiburn means" Az. Patent i2013 0009 from 06.03.2013; "Remedy" of Az. Patent i2013 0008 from 06.03.2013.

Firstly, in practice of medical sciences had been discovered lymphotropic properties of being elaborated by us medical preparations. It had been investigated the lymphatic properties in clinical practice during several pediatric diseases such as: anemia, pure meningitides, atopic dermatitis, several respiratory diseases and also in pathologic conditions as thymomegalia and thymico-lymphatic conditions.

Also in adults in cases of oncologic diseases and different diseases continued by depressing of immune system. The purpose of presented work is presentation of lymphotropic action of several preparation of licorice and practical usage them in several diseases.

### **Materials and methods**

The materials of investigation were newly elaborated pharmaceutical forms on the basis of Licorice: the dry water extract of Licorice, the dense water extract of Licorice, syrup of Licorice, syrup of "Licorice Broncho", syrup of Licorice "Qripson", syrup of Licorice "Sed", syrup of Licorice "Immunovit", syrup of Licorice "Hem", syrup of Licorice "Sed", syrup of Licorice "Cardio", syrup of Licorice "Broncho", syrup of Licorice, dry extract of Licorice, dense extract of Licorice. The methods of studying of lymphotropic activity of being noted preparations had been held in 160 rabbits (kind of shinshilla) with weight of them 2,5-3 kg. Firstly, had been determined influencing investigated preparations for lymphatic coagulation and them speed of lymph drainage. In experiments **in vitro** had been used fibrinogen, thrombin. In experiments of **vivo** had been used a hemacoagulographic devise (ГК ГМ-4-02).

About functional condition of coagulated activity of blood being proposed several results: the time of coagulation (Lee, White 1913), the time of recalcification (Berzerhorff, Roka, 1954), the time of thrombosis (Sirmai E., 1957), protrombin index (Quick P.A., 1928), fibrinogen concentration (Rutberq 1961). The process of taking the

blood portion was created in v. auricularis of rabbit and lymph portion was taking by method of A.A. Karnienko (1977) by modification of M. Kh. Aliyev and V.K. Mamedov (1989). The speed lymph drainage being determined refers to value of lymph. That was being drained from thoracic vessel.

Table 1

**The effect of dry licorice extract to lymphocoagulation**

Determined indicators	Initial results	Obtained results (in hours)			
		0,5	1	3	24
Time of coagulation (sec.) M±%P	308 ± 10,2 100	520 ± 20,0 132 0,001	550 ± 16,2 138 0,001	520 ± 14,2 134 0,001	320 ± 5,2 103 0,001
Time of recalcification (sec.) M±% P	208 ±5,2 100	260 ±8,6 120 0,01	242 ±12,2 120 0,01	228 ±12,2 11,2 0,01	224 ±20,6 101 0,01
Tolerance for heparin (sec.) M±% P	124 ±4,6 100	340 ±96 305 0,001	352 ±2,0 329 0,001	342 ±98 306 0,001	262 ±5,2 240 0,001
Thrombin time (sec) M±%P	23 ±0,8 100	45,1 ±6,2 2015 0,01	47,2 ±6,5 210 0,01	36,1 ±1,7 170 0,01	25 ±0,4 1104 0,001
Prothrombin index (%) M± %P	58 ±1,7 1,0	44,2 ±0,6 0,78 0,01	49,2± 0,5 0,75 0,001	38 ±1,0 0,74 0,001	54 ±0,4 0,96 0,001
Fibrinogen concentration (mq%) M±%P	72 ±4,2 1,0	66 ±4,2 0,92 0,05	50 ±4,2 0,73 0,005	58 ±6,4 0,78 0,005	64 ±4,4 0,9 0,005
Lymphatic speed M±m (ml/min) %P	0,17± 0,01 108	0,3± 0,07 170 0,05	0,36 ±0,04 260 0,05	0,38 ±0,05 210	0,31 ±0,08 175 0,05

The dry water extract of Licorice – 1250 mg/kg, the dense water extract of Licorice – 1260 mg/kg, syrup of Licorice – 1350 mg/kg, syrup of "Licorice Broncho" – 1320 mg/kg, syrup of Licorice "Qripson"-1280 mg/kg, syrup of Licorice "Sed"-1310mg/kg, syrup of Licorice "Immunovit"-1420mg/kg, syrup of Licorice "Hem"-1380 mg/kg, syrup of Licorice "Sed"-1260 mg/kg, syrup of Licorice "Cardio"-1420 mg/kg, syrup of Licorice "Broncho"-1320 mg/kg, syrup of Licorice-1350 mg/kg, dry extract of Licorice- 1250 mg/kg, dense extract of Licorice -1150 mg/kg.

**Results and Discussion**

The acute toxicity of all the listed pharmaceutical preparations of licorice on out bred white mice was studied. The acute toxicity of preparations had been held in white

mice's (with weight 30,0-35,02 ) by total number of 80, that mice's beforehand being divided in 2 groups. We had 10 serial subgroups by 8 units. It had been noted lethal dosage (DL<sub>50</sub>) for being phased out preparations. This way, had been discovered the water forms of dense and dry extracts and also syrups had less toxicity and practically harmless for **per os** usage. It was found that the test substances Licorice bare harmless and low toxicity. Then the effect of individual medicinal forms of licorice on blood clotting, antisloding and fibrinolysis of blood and lymph, as well as some parameters that allow to judge about the formation and outflow of lymph was studied. Experimental studied have shown that drugs licorice: water extract, thick extract, dry extract in dose 0,1 ml/kq have a marked anticoagulant and pronounced lymphogenous effect (Table 1, 2, 3). Comparative studied of lymph coagulation have shown that the drug causes a gradual increase in the clotting time of the lymph during the first hours of observation. The recalcificati on time increased but then quickly slowed down returning in a day to the initial level. The rate of lymphatic drainage increased 1,8 times in the first hours, and the next day it remained 1,5 times higher than the baseline.

Table 2

**The effect of thick licorice extract to lymphocoagulation**

Determined indicators	Initial results	Obtained results (in hours)			
		0,5	1	3	24
Time of coagulation (sec.) M±%P	408 ±10,2		650		
	100	620± 2,0 132 0,001	±16,2 138 0,001	620 ±14,2 134 0,001	420 ±5,2 103 0,001
Time of recalcification M±(sec.) % P	206 ±5,2		240		204
	100	280 ±8,6 120 0,01	±12,2 120 0,001	220 ±12,2 11,2 0,01	±20,6 101 0,01
Tolerance for heparin (sec.) M±% P	104 ±4,6		332 ±2,0		242 ±5,2
	100	320 ±96 305 0,001	158 0,001	322 ±98 306 0,001	240 0,001
Thrombin time (sec) M±%P	22 ±0,8		46,2 ±6,5		24 ±0,4
	100	44,1 ±6,2 201 0,01	210 0,01	36,0 ±1,7 170 0,001	110 0,001
Prothrombin index (%) M± %P	66 ±1,7		50,2 ±0,5		64 ±0,4
	100	54,2 ±0,6 0,78 0,001	0,75 0,001	48 ±1,0 0,74 0,001	0,96 0,001
Fibrinogen concentration (mq%) M±%P	82 ±4,2		60 ±4,2		74 ±4,4
	1,0	76 ±4,2 0,920,05	0,73 0,005	0,78 0,005	0,9 0,005
Lymphatic speed M±m(ml/min) %P	0,18 ±0,01		0,3 ±0,07		0,32
	108	0,3 ±0,07 170 0,05	0,45 ±0,04 260	0,38 ±0,05 210 0,05	0,32 ±0,08 176 0,05

Analysis of the results of studies conducted on a comparative pharmacological study of the lymphotropic activity of the listed medicinal plants provided a basis for judging about their high lymphogeno us activity. In order to judge the bioavailability of the studied substances as well as to identify the products of their biotransformation in living organisms and biological fluids (blood and urine), a pharmacokinetic analysis was performed on rabbits. Optimal conditions for isolating the studied substances and their metabolites from bio objects, as well as methods for their qualitative identification were developed. Then a scheme and method of expression analysis of triterpen compounds of licorice and their metabolites from biological fluid of the body were developed for laboratory-diagnostic analysis.

Table 3

**The effect of water licorice extract to lymphocoagulation**

Determined indicators	Initial results	Obtained results (in hours)		
		0,5	1	24
Time of coagulation (sec.) M±%P	480±20 100	540 ± 8,5 112	520 ± 8,8 109	520 ± 10 101
Time of recalcification M±(sec.) % P	130 ± 9 100	190± 11 145	214 ± 21 162	190 ± 16 142
Prothrombin index (%) M± %P	58 ± 4,7 1,0	34 ± 4,2 0,59 0,01	26 ± 2,1 0,45 0,05	54 ± 2,9 0,93 н.д.
Tolerance for heparin (sec.) M±% P	104 ± 8,5 100	230±21 224	215 ± 11 206	123 ± 11 118
Thrombin time (sec) M±%P	16 ± 1 100	27 ± 1,7 169	38 ± 2 244	25 ± 2,7 156
Fibrinogen concentration (mq%) M±%P	74 ± 7,5 1,0	37 ± 7,5 0,5 0,01	22 ± 6 0,3 0,01	52 ± 7,5 0,7 0,05
Lymphatic speed M±m (ml/min) %P	0,2 ± 0,03 100	0,3 ± 0,06 150 0,01	0,45 ± 0,03 265 0,01	0,45 ± 0,06 280 0,01

This information allows makingan opportunity to discuss, that the studied medicinal forms of licorice are safe and have a stimulating effect on both the lymph and the immune system. Identified lymphogeno us or lympho-stimulating with a small anticoagulant effect, as well as immunotropic effects characterize the licorice naked as a sorce of valuable drugs with lymphotropic activity. Experimental studied of the lymphotropic properties of bare licorice and its medicinal substances create the conditions for their possible use in practical medicine for the prevention and treatment of various diseases with reduced function of the immune system.

## References

1. Аммосов А.С., Литвиненко В.И., Попова Т.П. Солодка: применение в мировой практике обзор по материалам охраняемых документов за период с 1901 по 2018 гг. <http://farmacomua.narod.ru/Licoricepatent/acticle.html>
2. Балтина Л.А., Шульц Э.Э., Толстикова Г.А., Покровский А.Г., Толстикова Т.Г. Солодка, биоразнообразие химия, применение в медицине, Новосибирск, 2007
3. Велиева М.Н. Солодка и ее применение в медицине (монография) Баку, 2012, 265с.
4. Велиева М.Н., Велиев П.М. Разработка фармацевтических и парафармацевтических средств на основе солодки голой // Доклады Академии Наук Азербайджанской Республики, Баку, 2012, с. 97-102
5. Велиев П.М. Эффективность применения иммуностимулирующих препаратов солодки голой в комплексном лечении некоторых болезней у детей. Автореферат дис. канд. мед. наук, Москва, 1996, 20 с.
6. Вопросы изучения и использования солодки в СССР. М.; Л.: Наука, 1966. 367с.
7. Kitagai A., Yano S., Takeuchi R., Nishino K., Asanima Y., Nanaboshi M., Yamamuga Y. // *Endocrinology*, 1964, V.74 (1). P. 145-149.
8. Tanqri K.K., Seth P.K., Parmar S.S. Bhargara K.P. // *Biochem. Pharmacol.* 1965, V.149 (5). P. 1277-1281

## ASSESSMENT OF THE PERSONAL POTENTIAL'S PROFESSIONALISM LEVEL BY MODIFIED WEIGHTED SUM MODEL

**A.F. Musayev**

*ANAS Institute of Economy; The University of Azerbaijan, Baku, Azerbaijan.  
E-mail: [akif.musayev@gmail.com](mailto:akif.musayev@gmail.com)*

### Abstract

This study investigates evaluation of the professionalism level of delegation who are employees of institution, organization or state authorities. Valuation realizes by leaders. In most cases, utilized factors in making a decision that quantitative assessment is impossible and are characterized uncertainly, depend on the subjective approach of them. For eliminating uncertainty and subjectiveness significantly, assesment is implemented by modified weighted sum model according to definite interval as a multi-criteria making decision problem, based on the specific weight of each of employee's



criteria (quantity, quality, creativity and ethical behavior). As a result, the determining of professionalism level is definite by evaluation base on expert decision.

**Keywords:** Assessment method, Making Decision problem, Multi-Criteria Choice, Fuzzy Logic, Special Weight, Level of Profession, Weighted Sum Model.

## **Introduction**

Professionalism level of employees is the combination of the expected qualities that i the ability to demonstrate behavioral attitudes such as responsibility, courtesy and honesty when dealing with colleagues and clients. Fuzzy Logic is a powerful tool that helps managers for evaluating employees as group or individually by maksimum eliminating subjectiveness. In this article, two methods of multi-criteria making-decision problem [1] based on the fuzzy logic for determining professionalism level of the employees have used: weighted sum model for assessment and expert making-decision method for defining levels. The weighted sum model (WSM) is one of the most widely used and simple methods that proposed by Peter C. Fishburn in 1967 [2].

This method evaluate alternatives based on the weight (Determination of weights is one of the most important issues of the MCDM methods and reflects the individual choice of the decision maker. If the significance of the criteria is the same, weights are equal. If different, they are determined for their importance by paying the given terms) of the criterion. However, in our paper, the known method has been developed and the alternatives have been evaluated by determining the specific weight for each criterion for the assigned intervals. The origin of Decision expert (DEX) method is coming from the idea that was presented by Efstathion and Rajkovic in 1979. Their proposal was to use words instead of figures and tables instead of functions. In 1983 this method has been developed by a research team of M. Bohanec, I. Bratkoand V. Rajkovic [3, 4].

Different methods and approaches have been used for assessment of professionalism in various fields. Imtiaz Ahmed offered an assessment system that taking into account different criteria, based on fuzzy logic in 2013. The main task in this approach involves determining the performance indices of employees considering their respective performance in various qualitative and quantitative evaluation criteria and then selecting the best employee who holds highest performance index comparing all the indices [5]. In 2004, the approach offered by Ginsburg S, Regehr G, Lingard L. assessed the professional based on the behavior and interpretation of the students [6]. In2007, the evaluation of professionalism level of employees was investigated to four criterias (work achievement, skill knowledge, personal quality, and community services) by hierarchical fuzzy inference approach based on fuzzy logic [7].

## 1. Statement of problem

In general, we can mention that the effectiveness and competitiveness of any enterprise and organization depends on significantly, the level of professionalism of its staff at all levels. The executive director with the specific methodology assesses the employees' activities. The proposed methodology in this article based on the specific weight sum of the employees' activities by the given criterias. Here, the director in accordance four criteria determines the activities of the employees during the valuation period and each of these criteria consists of the following sub-indicators [8]:

1. Quantity - represents the quantitative
2. Measure of the worker's main activity that is, shows the amount of work performance.
3. Quality - characterizes the following
4. Aspects of the manager's activity: planning aptitude, organizational capacity, management and supervision capability, decision-making ability.
5. Creativity criterion involves following;
6. Ability to know of functional components of the work, their relationships with other fields and features of them, to analyze;
7. Ability to analyze information obtained in the work process, to distinguish important and secondary factors and to find the solution of the problem, ability to develop staff;
8. Capability to evaluate fulfillment of tasks, to arrange teaching, development and guidance and to solve employee's problems;

Professional ethics criteria consist of sub-criterias as below:

To protect of service and professional reputation, to prefer the interests of the state, the society and the enterprise when responsible tasks are fulfillment, not allowing actions that violate professional reputation.

To follow courtesy rules, be courteous and at the same time decisive in the performance of his duties. To prefer the enterprise and public interests over their interests, not accept gift (not give).

Let us mention following:

Every employee as an alternative:  $A_j, j=1\dots m$ ;

Each criteria:  $C^k, k=1\dots K$ ;

Sub-criterias of each main criteria  $c_{ij}^k$  (i-ci kriteriya, j-ci alternativə uyğun)  $k=1\dots K, i=1\dots n_k, j=1\dots m$ .

## 2. Application of the method for solving the problem

While determining the professionalism level of employees, all the criterias that characterize their performance should be taken into consideration, namely, quantitative, qualitative, creative and ethical behavior. For realizing it, the following steps are accomplished:

1. The average value of each criteria is determined as below, using the sub-criterias:

$$\overline{c_j^k} = \frac{\sum_{i=1}^{n_k} c_{ij}^k}{n_k}, k=1\dots K, j=1\dots m. (1)$$

2. The interval (0, 1) divided into 5 parts (0, q1), (q1, q2), (q2, q3), (q3, q4), (q4, 1) with q1, q2, q3, q4 points;

Specific weights  $w_j^{ks}$  ( $k=1,2,3,4$ ;  $s=1,2,3,4,5$ ,  $k$ -criterias,  $s$ -intervals) of each criterion define in the assigned intervals (table 1).

The average value of each criterion is evaluated for each alternative by checking according to intervals as follows :

If  $c_j^k < q_1$ , then according to interval  $s=1$ ;

If  $q_1 < c_j^k < q_2$ , then according to interval  $s=2$ ;

If  $q_2 < c_j^k < q_3$ , then according to interval  $s=3$ ;

If  $q_3 < c_j^k < q_4$ , then according to interval  $s=4$ ;

If  $q_4 < c_j^k < q_5$ , then according to interval  $s=5$ , evaluation of the professionalism level of employees is calculated by the following formulation:

$$A_j = \sum_{k=1}^K \overline{c_j^k} w_j^{ks} \quad (2)$$

$\overline{c_j^k}$ ,  $k=1\dots K$ ;  $j=1\dots m$  - the average value which calculated by (1);

$A_j$ ,  $j=1\dots m$  - alternatives (employees);

$w_j^{ks}$ ,  $k=1\dots K$ ;  $j=1\dots m$ ,  $s=1\dots 5$ , - the weights in accordance with every interval:  $\sum_{k=1}^K w_j^{ks} = 1$ ,  $w_j^{ks} \geq 0$ ;  $k=1\dots K$ ;  $j=1\dots m$ ;  $s=1\dots 5$ .

3. The professionalism level of employees based on obtained results, is defined by expert decision method, in 4 parts (0, K1); (K1, K2); (K2, K3); (K3, 1), within interval (0,1):

If  $0 \leq A_j \leq K_1$ , then the professionalism level is unacceptable;

If  $K_1 < A_j \leq K_2$ , then the professionalism level should be improved;

If  $K_2 < A_j \leq K_3$ , then the professionalism level is satisfactory;

If  $K_3 < A_j \leq 1$ , then the professionalism level is high.

The proposed approach has been assessed over the officials in the oil sector and the tax system.

### **3. As an example, the evaluation of the professionalism level of any tax officer has been looked through (table 2):**

According to the given data, we calculate the average value for each indicator via (1) formulation:

$$\overline{c_j^1} = 0.42; \overline{c_j^2} = 0.5; \overline{c_j^3} = 0.58; \overline{c_j^4} = 0.375$$

Specific weights  $w_j^{ks}$  ( $k=1,2,3,4$ ;  $s=1,2,3,4,5$ , k-criterias, s-intervals ) of each criterion that participates for forming of professionalism level are defined in the assigned intervals by the experts (table 3):

The assessment of employee's (level of professionalism) professionalism level according to each criterion is calculated with the (2) formulation, using the average value of the criteria and table 3 and by checking the step 4 that mentioned above:

$$A = 0.465, (k=1); A = 0.453, (k=2); A = 0.453, (k=3); A = 0.465, (k=4);$$

The obtained results are determined by the expert decision method according to range (0, 0.25), (0.25, 0.5), (0.5, 0.75), (0.75, 1)

Based on an assessment, we can mention that the professionalism level of the officer is in the interval (0, 0.5), that is, it should be improved.

### **Conclusion**

In this article, the professionalism level of employees under uncertainty has been investigated as a multi-criteria making decision problem and evaluated by using the modified weight sum model. Based on the results of the evaluation, the professionalism level of the employees has been determined by the expert decision.

Using such a methodology, the following consequences are achieved:

1. Efficient and competitiveness activity of an enterprise, organization or state authorities is increasing;
2. It gives an opportunity to employees be protected their interests, be advanced on their career and be rewarded them according to the results that they get;

3. Subjectivity is prevented by the assessment. Hostility and injustice are eliminated in making the decision by the direct director.
4. Helps the main leadership to make the right decision.

Table 1

**Specific weights of each criterion**

<b>Criteria</b>	<b>0-q1</b>	<b>q1-q2</b>	<b>q2-q3</b>	<b>q3-q4</b>	<b>q4-q5</b>
Quantity	$w_j^{11}$	$w_j^{12}$	$w_j^{13}$	$w_j^{14}$	$w_j^{15}$
Quality	$w_j^{21}$	$w_j^{22}$	$w_j^{23}$	$w_j^{24}$	$w_j^{25}$
Creativit.	$w_j^{31}$	$w_j^{32}$	$w_j^{33}$	$w_j^{34}$	$w_j^{35}$
Ethical behavior	$w_j^{41}$	$w_j^{42}$	$w_j^{43}$	$w_j^{44}$	$w_j^{45}$

Table 2

**The informative table of their sub-indicators for evaluating each criterion**

<b>№</b>	<b>Criteria</b>	<b>Cost</b>	<b>Conditional point</b>
<b>Quantity</b>			
1	How many legal entities have conducted an itinerant tax inspections in the last reporting year?	8	0.5
2	How many legal entities have violated the tax legislation?	7	0.25
3	How many officials of legal entities have drawn up a protocol on administrative violation?	7	0.25
4	How many thousand manats of administrative penalties are?	2.200 1.950	0.5

5	An average statistical taxpayer during the mobile tax inspection for the last reporting year: - How many thousand manats calculated as an additional tax amount? - How many thousand manats imposed as financial sanctions? How many thousand manats have been provided for additional funds and imposed sanctions?	120.000 55.000 167.000	0.6
<b>Quality</b>			
1	Planning ability. Defining goals and predictions, action strategies and techniques, compiling schedule, and procedures.		0.5
2	Organizational capability. Grouping areas of activities for achieving the goal, accurate defining competence and responsibilities of employees, increasing the efficiency of operations and avoiding conflicts.		0.75
3	Management and control ability. The ability of leadership and observation, justify, coordination and improving the process of leadership, develop and execute the performance standards.		0.5
4	Make a decision. Ability to evaluate alternate activity, to realize right option quickly and accurately in these or other situations.		0.25
<b>Creativity</b>			
1	Ability to know of functional components of the work, their relationships with other fields and features of them, to analyze		0.25
2	Ability to analyze information obtained in the work process, to distinguish important and secondary factors and to find the solution of the problem, ability to develop staff.		0.75

3	Ability to develop staff. Capability to evaluate fulfillment of tasks, to arrange teaching, development and guidance and to solve employee's problems.		0.75
<b>Professional ethics</b>			
1	To protect of service and professional reputation; to prefer the interests of the state, the society and the enterprise when responsible tasks are fulfillment, not allowing actions that violate professional reputation.		0.25
2	to follow courtesy rules, be courteous and at the same time decisive in the performance of his duties		0.5
3	To prefer the enterprise and public interests over their interests, not accept gift (not give).		0.5
4	Whether or not to accept gifts or other privileges beyond the limits of ordinary courtesies to the benefit of others when there are suggestions that are intended to affect the fulfillment of these duties in connection with the performance of their professional duties.		0.25

Table 3

**Particular weight ratios of each criteria according intervals**

Criteria	0-0.45	0.45-0.6	0.6-0.75	0.75-0.87	0.87-1
	Particular weight coefficient				
Quantity	0.4	0.5	0.6	0.7	0.8
Quality	0.25	0.2	0.15	0.15	0.1
Creativity	0.2	0.15	0.13	0.08	0.05
Ethical behavior	0.15	0.5	0.12	0.07	0.05

## References

1. Triantaphyllou E. Multi-criteria Decision Making Methods. A Comparative Study (2000).
2. Fishburn P.C.: Additive Utilities with Incomplete Product Set: Applications to Priorities and Assignments. Operations Research Society of America (ORSA), Baltimore, MD. U.S.A (1967).
3. Bohanec M., Bratko I., Rajkovič V.: An expert system for decision-making. Processes and Tools for Decision Making (ed. H.G. Sol), North-Holland, pp 235–248 (1983).
4. Bohanec M.: DEXi: A Program for Multi-Attribute Decision Making (2012).
5. Imtiaz Ahmed, Ineen Sultana, Sanjoy Kumar Paul, Abdullahil Azeem, (2013) "Employee performance evaluation: a fuzzy approach", International Journal of Productivity and Performance Management, Vol. 62 Issue: 7, pp.718-734, <https://doi.org/10.1108/IJPPM-01-2013-0013>
6. Ginsburg S, Regehr G, Lingard L. Basing the evaluation of professionalism on observable behaviors: a cautionary tale. 2004 Oct; 79(10 Suppl): S1-4
7. Nureize Arbaiy, Zurinah Suradi. Staff Performance Appraisal using Fuzzy Evaluation / AIAI 2007: Artificial Intelligence and Innovations 2007: from Theory to Applications, pp 195-203.
8. Musayev A.F., Kalbiyev Y.A., Huseynov A.A.: The tax system of Azerbaijan Republic: reforms and results. Baku (2002).

## **BALLON TAMPONADE AS A METHOD OF PREVENTION AND TREATMENT OF POSTPARTUM HAEMORRHAGE**

**<sup>1</sup>Gurbanova D.F., <sup>2</sup>Ali-zada S.F., <sup>3</sup>Huseynova S.A.**

*<sup>1,2,3</sup>Research Institute of Obstetrics and Gynaecology Baku, Azerbaijan*

*e-mail: jkurbanova@hotmail.com*

*alizade\_s@yahoo.com, sadi\_0105@mail.ru*

**Key words:** postpartum hemorrhage, ballon tamponade, maternal mortality, blood loss, massive bleeding, bleeding stop

## **Introduction**

Postpartum hemorrhage (PPH) is one of the leading causes of maternal morbidity and mortality, ranking third after thromboembolism and hypertensive disorders /1-7/.

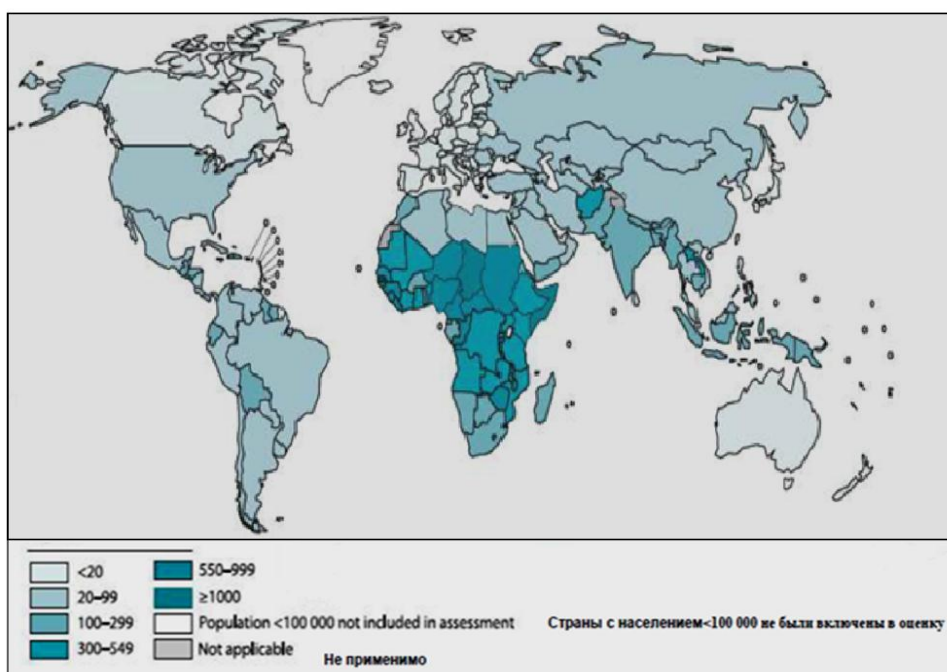


Despite the scientific and practical achievements of world medicine in obstetric practice and qualifying obstetric and gynaecological care for pregnant women and women in labour, PPH still continue to remain relevant. According to WHO materials, PPH is defined as a blood loss of more than 500 ml after vaginal delivery or more than 1000 ml after caesarean section /8-10/. According to WHO experts, about 830 women die every day in the world from preventable causes related to pregnancy and childbirth /11/.

According to the latest Bulletin of the American College of Obstetricians and Gynaecologists, 140,000 cases of maternal mortality (MM) occur annually and approximately every 4 minutes 1 woman dies from PPH /12/. According to statistics, more than 130 thousand women die each year in the world from PPH as a direct cause of MM, half of which die from uterus hypotension /2, 3/. More than 529 thousand women die annually from complications associated with both pregnancy and childbirth. At least in every 4<sup>th</sup> observation, the cause of the fatal outcome is haemorrhage /12/. Thus, according to the WHO, PPH is an emergency obstetric pathology that transforms the normal physiological process of labour into a life-threatening condition.

According to some authors, up to 86.3% of cases of MM can be prevented or prohibited for which it is necessary to identify not only risk factors and causes (taking into account the genesis of haemorrhages), leading to a fatal outcome, but also to analyze the cases of preventing critical cases in obstetrics /15-23/. Consequently, at present, an organ-preserving strategy dominates, aimed at the rehabilitation of impaired organ functions. The conservative and surgical steps continue to be the protocol for the provision of basic care for PPH. Today, a strategic approach to combat PPK is to stop it at a conservative stage /24, 25/. One of the methods for stopping PPH is the balloon tamponade (BT) of the uterus, which today is a high-tech and effective way to prevent and treat PPH /3, 24, 26, 27/. This method can be applied in the early stages of postpartum haemorrhage, preventing the development of massive blood loss, which is especially important for everyday obstetric practice. The **aim of the study** has been to determine the effectiveness of the use of the balloon tamponade method in the prevention and treatment of postpartum haemorrhage. We've examined 112 puerperas with PPH of varying severity. The baseline study has included retrospective and prospective studies. Depending on the treatment tactics, women with haemorrhage have been divided into II main levels. Retrospective studies (balloon tamponade not performed) have consisted of 72 patients, of whom 34 gave birth through the birth canal; 38 - after delivery by caesarean section. We've used a combined tactic (retrospective studies - balloon tamponade not performed), which included n=72 patients (of which 34 women had vaginal delivery; 38 had operative delivery), with using the standard obstetric tactics, they've made Level I. A prospective study has been conducted (n=40) for women who underwent a balloon tamponade according to the method of Zhukovsky Y.G. (20 - vaginal

delivery; 20 - caesarean section) and who made Level II. Level III: the control group (CG), which was n=30 conditionally healthy fertile women who did not have PPH during childbirth. The age of the examined women has varied from 18 to 44 years and older, the average age was  $31 \pm 13$  years. The clinical examination has included a medical history, clinical, laboratory and instrumental examination methods (hemostasiogram, including clinical and biochemical analyzes: coagulogram with the determination of platelets, fibrinogen, activated partial thromboplastin time (APTV), prothrombin time (PT), determination of blood clotting using Lee-White method, as well as ultrasound, cardiotocography, Doppler sonography, assessment of the biophysical profile of the foetus, etc.).



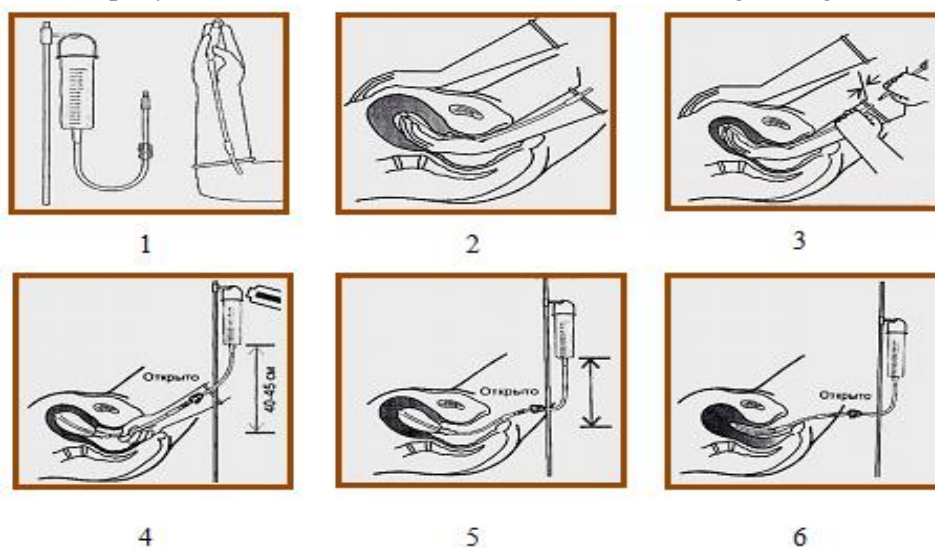
**Fig.1. Maternal mortality according to the Royal College of Obstetricians and Gynaecologists and WHO /13, 14/**

### **Materials And Methods**

Studies have been performed before delivery, and then in 1-3 hours and 24 hours after delivery. The sequence of actions (steps) of ballon tamponade (BT) during natural childbirth in women in labour with PPH: it is necessary to start BT by placing the reservoir on the rack for intravenous infusions at a height of 45-50cm above the puerpera level. Fill the system with a completely sterile warm solution from the vial, holding the free end of the tube above the reservoir.

Cover the lumen of the filled tube with a clamp, lowering the free end of the tube below the reservoir to remove air bubbles (Steps 1; 2; 3); (see Fig.2). Step 4: introduction of a balloon catheter into the uterine cavity is a key step that determines the effectiveness of BT. Step 5 is based on the connection of the open end of the balloon catheter with the tube of the filled reservoir (Fig.2).

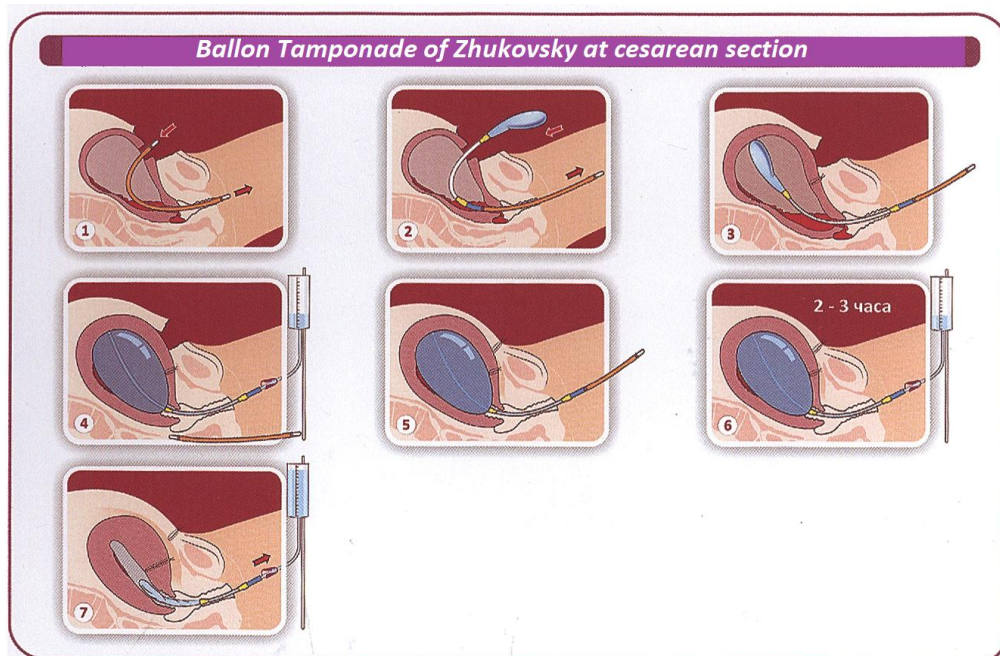
After performing Steps 1 through 5 with any technique of inserting a catheter into the uterine cavity, Step 6 common to these techniques begins - opening the clamp on the tube. This activates the phenomenon of ‘communicating vessels’ between the balloon and the reservoir. After opening the clamp, the level of the solution in the reservoir begins to decrease rapidly, due to its movement into the lumen of the straightening balloon.



**Fig.2. (Steps: 1; 2; 3; 4; 5; 6). Stages of balloon tamponade during natural childbirth in women in labour with PPH (Zhukovsky method)**

A warm solution is added to the reservoir synchronously. The replenishment of the solution in the reservoir continues until the solution level in the middle of the reservoir is stabilized. On average, 350-400 ml of solution are consumed to fill an communicating ‘balloon-reservoir system’. If possible, ultrasound should be used to control the position and expansion of the balloon in the uterine cavity. The uterus tamponading: the expanded balloon is held in the uterine cavity with the clamp open and the steady level of the solution in the reservoir at a half-meter height (Fig.2). This ensures moderate pressure of the balloon wall on the entire inner surface of the uterus. While maintaining this state, usually within 1 hour, signs of recovery of the contractile function of the uterus appear. This is diagnosed by increasing the level of the solution in the reservoir, since due to a decrease in the size of the uterus cavity the liquid from

the balloon begins to be displaced into the reservoir. This recovery rate of contractile activity of the uterus, within 1 hour, is a valuable distinguishing characteristic of the Zhukovsky BT method. In rare cases, if BT is not sufficiently effective, the reservoir should be raised another 10-15cm to increase the pressure of the balloon wall on the bleeding vessels of the placental site. In Fig.3 the technique of BT at caesarean section is presented. The technique of carrying out Zhukovsky balloon tamponade at caesarean section included: 1) retrograde introduction of a plug conductor into the cervical canal; 2) attachment of the catheter to the conductor-plug and introduction of a catheter into the uterine cavity; 3) uterus closure; 4) filling the balloon with warm saline solution (38-39°C); 5) disconnecting the reservoir from the cylinder; 6) monitoring the patient in the intensive care unit; 7) removing the balloon catheter. Thus, the BT technique allows detecting early signs of recovery of the contractile activity of the uterus, not interfering with the healing process, but following it, by reducing the volume of solution in the balloon, until the haemorrhage stops completely.



**Fig.3. (Steps: 1; 2; 3; 4; 5; 6; 7) Methods of carrying out Zhukovsky balloon tamponade at cesarean section**

If we analyze the method of carrying out balloon tamponade, then this Zhukovsky technique is based on the principle of 'open circuit' and the law of communicating vessels /27/. This method is safe and highly effective in application for stopping PPH,

which is especially important for practical obstetrics. Diagnosis of PPH was performed immediately after the birth of the afterbirth (external examination of the uterus with an assessment of its contours, size and tone); signs of haemorrhage in the postpartum period; control of external haemorrhage volume; exclusion of intra-abdominal haemorrhage; assessment of the puerpera's state; we've also monitored the deposition of blood into the uterine cavity using ultrasound and monitoring of basic hemodynamic parameters. As of state: there have been defined KOS, group incompatibility, Rh factor, blood test for infections, carriage of hepatitis B and C. According to the WHO materials "on the prevention and treatment of postpartum haemorrhage" (Geneva, 2014) /28, 29/, PPH were classified into IV degree for the severity. A "tamponade test" has been conducted, which included: a "positive test" (after filling the ballon, the haemorrhage stops), that determined that there was no need for a laparotomy. "Negative test" (after filling the ballon haemorrhage continues) has been an indication for laparotomy. According to the indications, compression stitches have been made on the uterus (B-Lynch method). Internal iliac arteries have been ligated, if required (considered as a conservative surgical intervention). According to the indications, hysterectomy has been applied. To stop the PPH, we've used the ballon uterus tamponade according to the method of Zhukovsky Y.G. /27/.

The indications for use of the ballon uterus tamponade have been continued haemorrhage after a manual examination of the walls of the uterus: impaired uterine contraction (hypo or atony) and exclusion of other possible causes of haemorrhage (delayed parts of the placenta or blood clots in the uterus, trauma of the birth canal, impaired blood coagulation function, etc.).

### **Results and Discussion**

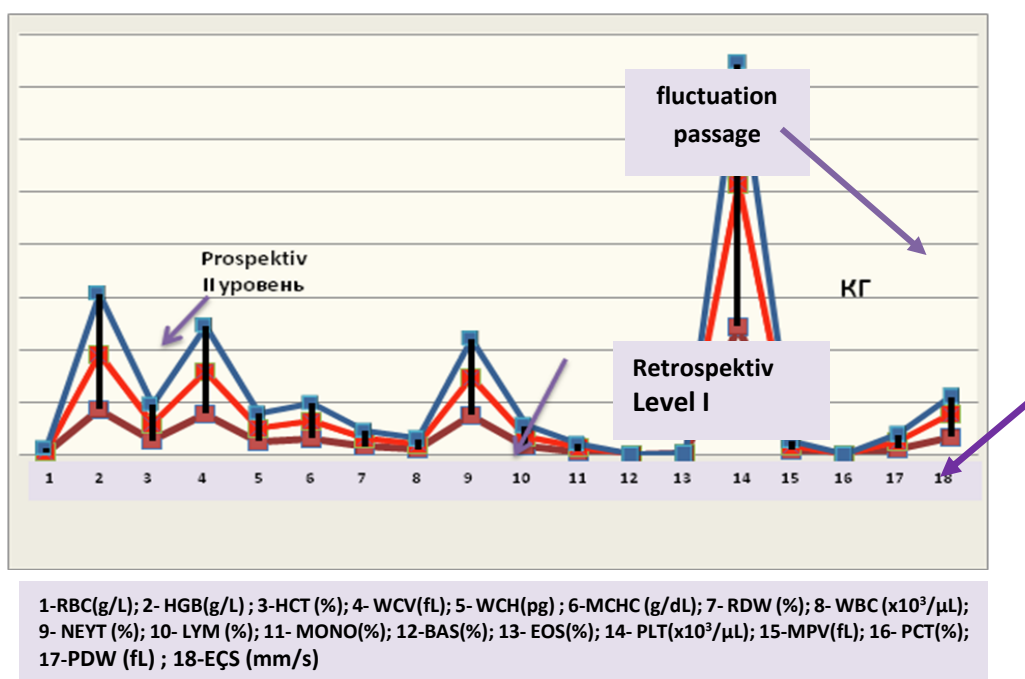
Analysis of parity has showed that the majority of women in labour were secundipara, 73(65.2%); primipara accounted for 39(34.8%) cases. PPH has been most often noted in women of late reproductive age: their specific weight was 76(67.9%), whereas PPH of puerperas of active reproductive age was 36(32.1%) cases. The structural characteristic of extragenital diseases in women with PPH has showed the predominance of blood system diseases (iron deficient, hemorrhagic, hypercoagulable anaemia, thalassemia, HELLP syndrome) - 56(50%) cases; endocrine diseases - 13(11.6%); diseases of the cardiovascular system have been recorded in 6(5.4%) cases; diseases of the gastrointestinal tract have been noted in 5(4.5%) cases; infectious diseases (hepatitis B and C) in 4(3.6%); diseases of the organs of sight in 2(1.8%); diseases of the genitourinary system in 1(0.9%) case.

The structural characteristics of gynaecological diseases in women with PPH have showed the dominance of uterine myomata (including multiple uterus myomata, uterine

fibromyomata, myomatous nodes) which have been noted in 13(18%) cases; cervical erosion in 3(2.7%) cases. The risk factors for PPH in women in labour in our study have been: the age of mothers over 35 years old - 16(14.3%); the threat of miscarriage - in 11(9.82%); spontaneous miscarriage - 6(5.35%); preeclampsia and HELLP syndrome - in 4(3.57%); medical abortions - in 23(20.5%); injuries of the soft birth canal - in 13(11.6%) cases; antenatal foetal death - 4(3.57%) cases; induction of labour - 11(9.82%); arterial hypertension - in 3(2.7%); obesity of Degr. II-IV - 5(4.46%) cases, large foetus - 9(8%) cases, respectively, etc. Thus, all women in labour have a risk of PPH, even in the absence of predisposing factors. Comparative statistical analysis of hemostasiogram in women in labour with PPH has revealed: a significant decrease in HGB; NST; WCV; LYM; PDW indexes; significant increase in the number of WCV; RDW; NEYT; PLT; EÇS. Significant changes in the MPV; PCT indicators have not been noted (Fig.4). It is known that the blood coagulation system is called haemostasis and protects the body from blood loss. Both endocrine and nervous functions of the body are responsible for the correct work of haemostasis. Undoubtedly, a decrease in blood clotting, hypocoagulation, carries the risk of developing uncontrolled haemorrhages. Hypercoagulation, on the contrary, leads to the formation of clots, i.e. thrombosis, which is fraught with the development of thrombosis and thromboembolism. As is known, a hemostasiogram is a set of blood parameters that characterize its ability to clot.

It is also known that the main indicator of the state of the haemostatic system is the prothrombin time, i.e. the time of formation of a thrombin clot which characterizes coagulation (plasma) haemostasis. This indicator characterizes Phases 1 and 2 of plasma coagulation and the activity of work of Factors II, V, VII and X. This test is used to assess the external mechanism of blood coagulation. Our studies have shown a shortening of the prothrombin time (PT) at comparable levels relative to CG:  $13.6 \pm 0.17$  sec and  $13.89 \pm 0.2$  sec in the Levels I and II, whereas in the Level III it was  $14.96 \pm 0.13$  sec, respectively ( $p < 0.05$ ; DI 95%).

PT shortening is characteristic of the last weeks of pregnancy. Active partial thromboplastin time is an indicator of the effectiveness of stopping haemorrhage by plasma factors, also characterizes coagulation (plasma) haemostasis and is the most sensitive and accurate indicator of hemostasiogram. In our studies, the APTV index has been recorded in intervals of  $30.67 \pm 0.42$  sec in Level I;  $31.88 \pm 0.63$  sec in Level II, whereas in CG APTV was  $30.78 \pm 0.7$  sec. Comparative analysis of the coagulogram has showed that the Quick values in Level I have been in the range of  $93.14 \pm 1.33\%$ ; in Level II,  $96.54 \pm 1.58\%$  with respect to CG -  $82.6 \pm 1.18\%$  ( $p < 0.05$ ; DI 95%), respectively. Quick is the prothrombin time of Quick.



**Fig. 4. Comparative chart of indicators of a gemostaziogramma at women in labor.**

Thrombin time (TT) is the third most important basic coagulation test characterizing the final stage of coagulation process, the conversion of fibrinogen to fibrin by the action of thrombin. The definition of TT is used to evaluate the anticoagulant activity of blood. In our researches, TT was: in Level II  $10.51 \pm 0.16$  sec and in Level I  $10.16 \pm 0.15$  sec, whereas in CG this indicator is  $10.08 \pm 0.13$  sec ( $p < 0.05$ ;

DI 95%). According to the international nomenclature, fibrinogen is factor I of the plasma coagulation system, the basic test for the study of haemostasis. According to the obtained results, at Level I the fibrinogen values of  $346.6 \pm 9.01 \text{ mg/dL}$  have been slightly higher than  $291.5 \pm 8.77 \text{ mg/dL}$  with respect to the CG; whereas in Level II, this indicator has been  $327.4 \pm 11.86 \text{ mg/dL}$  relative to the CG  $291.5 \pm 8.77 \text{ mg/dL}$ , respectively ( $p < 0.05$ ; DI 95%). The INR (International Normalized Ratio) Index is the international normalized ratio or prothrombin coefficient, this is the ratio of patient PT to normal plasma PTR in the degree of international sensitivity index. This indicator is a mathematically correcting quantity.

According to the generally accepted classification, a comparative analysis of both levels has revealed that early PPH prevailed in women in labour which was observed in 103(97.3%) cases, whereas later PPH was recorded in 3(2.7%) cases, respectively. According to the PPH classification by severity: Severity Degree I has been observed in 66(58.9%); Severity Degree II - 32(28.6%) cases; moderate Severity Degree III has been reported in 10(8.9%); Severe Degree IV - 4(3.6%) cases, respectively.

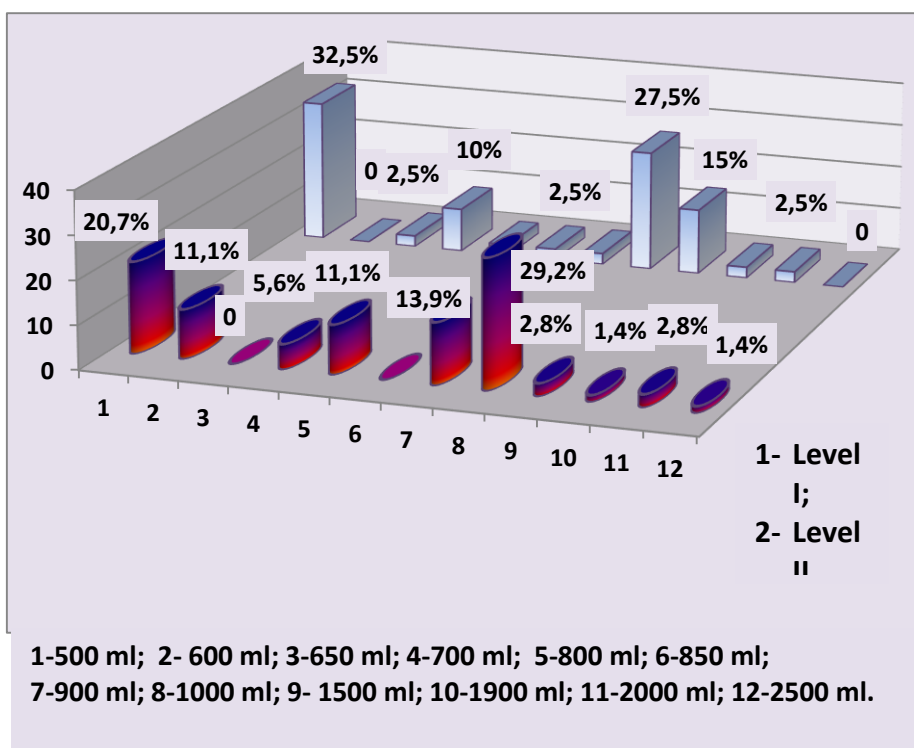


Fig.5. Diagram of the PPH frequency depending on the volume of blood loss



Our combined tactics for treating postpartum haemorrhage has included: surgical haemostasis (ligation of the ileal artery and imposition of compression stitches according to B-Lynch); mechanical pressure and drainage of the uterus using ballon tamponade; correction of coagulation disorders. Traditional tactics for blood loss exceeding physiological one, has included: manual and instrumental examination of the uterus, uterus massage, infusion and transfusion therapy using fresh frozen plasma, erythrocyte mass, tromboconcentrate, protease inhibitors, as well as surgical methods of haemostasis. It should be noted that the following interventions have been applied during childbirth (retrospective studies Level I - caesarean section): uterus massage; uterotonics (oxytocin, ergometrine, methylergometrine, misoprostol); infusion and transfusion therapy; also there have been carried out: uterus amputation (with/without appendages) - 14(36.84%) cases; hysterectomy (with/without appendages) - 6(15.8%); compression seams B-Lynch - 8(21%); relaparotomy - 3(7.9%) cases; ligation of the great vessels (internal iliac arteries) - 1(2.6%) case; the hysterectomy has been performed (with/without appendages) in 1(5%) of cases only with a prospective study Level II - vaginal delivery). Uterine balloon tamponade has been performed in 40(35.7%) cases. The principle of the ballon tamponade is to exert direct pressure on the bleeding vessels of the placental area by the wall of the ballon melted in the uterus. Intrauterine pressure on the bleeding placental area with a ballon melted in its cavity is considered by the world obstetrics a method of choice - the first step in the absence of the effect of uterotonics. The efficacy of treatment has been assessed according to 2 criteria: the volume of blood loss and the number of hysterectomies. The effectiveness of the use of ballon tamponade in our study has been 95% based on the complete absence of haemorrhage, as well as reducing the length of hospital stay for patients (a prospective study:  $5.0 \pm 1$  bed-days for vaginal births and  $7.0 \pm 4$  bed-days for caesarean section). Thus, the ballon tamponade using the Zhukovsky method has allowed us to solve three key tasks: first, to stop the haemorrhage quickly and with high efficiency; second, to identify in time women in labour for whom laparotomy is indicated, and proceed with the operation until the development of hemodynamic disturbances; third, to prevent unavoidable complications. Studies have shown that the use of the uterus ballon tamponade technique in the complex treatment of PPH leads to a significant reduction in the need for surgical gesmostasis, a reduction in the number of massive haemorrhages and organ-sparing operations by 95%. The system of examination proposed by us and step-by-step measures for early stopping PPH have allowed reducing the risk of pathological blood loss which is clinically significant for preventing maternal mortality and morbidity and justifying the use of this methodology as a mandatory step of the protocol for conservative measures to combat ongoing PPH. Thus, the conduct of this

study is relevant and is of scientific and practical interest in terms of the safe and effective application of the modern and new ballon tamponade method according to Y.G.Zhukovsky both for the prevention and treatment of postpartum haemorrhages.

### **Conclusion**

1. All women in labour have the risk of PPH, regardless of the method of delivery (vaginal or operative). The frequency of occurrence of risk factors in the structure of the occurrence of PPH has been: secundiparas (65.2%), the age of mothers over 35 years old (14.3%), uterine myoma (18%); injuries of the soft birth canal (11.6%); threat of termination of pregnancy (9.8%); induction of labour (9.8%); obesity (4.5%); antenatal foetal death (3.5%); large foetus (8%) of cases.
2. The indication for the use of ballon tamponade has been continued haemorrhage after an earlier manual examination of the walls of the uterus (an important condition): violation of uterine contraction (hypo 75% and atony 9.8%) and exclusion of other possible causes of haemorrhage (injuries of the birth canal 11, 6%, violation of blood coagulation (3.6%).
3. Timely detection and management of pregnant women threatened by haemorrhage and prevention of haemorrhage, as well as timely and full uterus ballon tamponade in a complex of measures to combat postpartum haemorrhages contributes to the preservation of the woman's life and generative function. The effectiveness of ballon tamponade was 95%, as evidenced by the complete absence of haemorrhage.
4. Ballon tamponade of the uterus is the rationale for using as a mandatory step in the protocol of conservative measures to combat the continuing PPH after a manual examination of the uterus.

### **References**

1. S.Ş. Həsənova. "Yüksək risk qruou olan qadınlarda erkən zahılıq düvrünün hipotonik qanaxmalarının müasir üsulla profilaktikası" Aftoreferat dis. t. ü. f.d. elmi dərəcə almaq üçün 2017, Bakı, 21 səh.
2. O.R. Baev, A.I. Davydov, "Postpartum bleeding: obstetric tactics and intensive therapy". Questions of Gynaecology, Obstetrics and Perinatology Journal. 2011, vol. 10(6), pp.65-69
3. E.M. Levite, I.G. Bobrinskaya, E.A. Chernov. "Operational blood loss: measurement, treatment" Russian Medical Journal. 2006, No. 3, pp.16-20
4. T.V. Legalov, I.I. Kukarskaya. "A modern approach to the conservative treatment of postpartum hypotonic haemorrhages using uterus ballon tamponade" J. Gynecology and Endocrinology. 2017, №9 (138), pp.52-57

5. E.A. Lyalina. "The management model of preventable risk factors for maternal mortality from obstetric bleeding in modern conditions" Abstract of medical sciences candidate thesis. Ivanovo, 2006, p.23.
6. P. Abedi, S. Jahanfar, F. Namvar, J. Lee. "Breastfeeding or nipple stimulation for reducing postpartum haemorrhage in the third stage of labour" The Cochare database of systematic review 1: CD010845.doi: 10.1002/14651858.CD010845. pub2.PMID 26816300; 2012
7. M. Balki, S. Dhumme, S. Kasodeka, G. Seawar et al. "Blood transfusion for primary postpartum haemorrhage: a tertiary care hospital review". Journal of Obstetrics and Gynaecology. Canada. 2008, vol. 30, №11, p. 1002-1007
8. Marcovici "Postpartum Haemorrhage - a review" *Jurnale de Chirurgie, Iasi*. 2005, vol. 1(4), pp. 8493
9. H. Soltan. T.A. Poulouse, D.R. Hutchon. "Placental cord drainage after vaginal delivery as part of the management of the third stage of labour" The Cochrane database of systematic review (9). 2011: CD004665.doi10.1002/14651858.CD004665.pub3.PMID 21901693
10. The Ministry of Health, Labour and Welfare in Japan. 2011. <http://www.winet.nwec.jp/toukei/save/xls/L100220.xls>.
11. Maternal mortality. World Health Statistics, 2014, Geneva, WHO, Newsletter No. 348, 2015
12. Z. Papp. "Massive obstetric hemorrhage" *J. Perinat. Med.* 2003, vol. 31(5), pp. 408-414
13. Royal College of Obstetricians and Gynaecologists. Prevention and management of postpartum haemorrhage. Geer-top Guideline No.52. London. RCOG; 2011
14. World Health Organization. International Statistical Classification of Diseases and Related Health Problems 10th Revision 2010 Available at: <http://www.who.int/classifications/apps/icd/icd10online/>
15. S.V. Barinov, Y.G. Zhukovskiy, V.T. Doldikh et al. "Novel combined strategy of obstetric haemorrhage management during caesarean section using Intrauterine ballon tamponade" *J. Matern. Fetal Neonatal Med.* 2016, vol. 1, pp. 1-5
16. S. Canonico, M.Arduini, G.Epicoco et al. "The placentaprevia/percreta: case of successful conservative surgical treatment" *J. Obstetricia e Ginecolodia*. 2012, vol.13, pp.11-13
17. G. Carroli, C. Cuesta, E. Abalos, A.M. "Gülmezoglu Epidemiology of postpartum haemorrhage: a systematic review" *Best Pract. Res. Clin. Obstet. Gynaecol.* 2008, vol. 22(6), pp.999-1012
18. L.B. Conrad, L.J. Groome, D.R. Black "Management of Persistent Postpartum Haemorrhage Caused by Inner Myometrial Lacerations" *J. Obstet. Gynecol.* 2015, vol. 126, pp.266-269
19. M. Della Torre, S.J. Kilpatrick, J.U. Hibbard, L. Simonson et al. "Assessing preventability for obstetric haemorrhage" *American J. Perinatol.* 2011, vol. 28(10), pp. 753-760

20. FIGO GUIDELINE Annotated version Treatment of Postpartum Haemorrhage with Misoprostol. International Federation Gynaecology and Obstetrics London, United Kingdom. May. 2012
21. G. Hofmeyr, H. Abdel-Aleem et al. "Uterine massage for preventing postpartum haemorrhage". The Cochrane Database of Systematic Reviews 7. 2013: CD006431.doi. 10.1002/14651858.CD006431.pub3. PMID 23818022
22. T. Ishii, K.S awada, S. Koyama, A.Isobe et al. Ballon tamponade during caesarean section is useful for severe post-partum haemorrhage due to placenta previa. // J. Obstet. Gynaecol. Res. 2012, vol. 38(1), pp.102-107
23. R.A. Kadir, C.E. Kingman, C. Chi et al. "Is primary postpartum haemorrhage a good predictor of inherited bleeding disorders?" J. Haemophilia. 2007, vol. 13, pp.178-180
24. A.P. Milovanov "Analysis of the causes of maternal mortality: a guide for physicians." M.: Medicine. 2008, p.228.
25. A.V. Mikhailov, M.L. Chekhonatskaya, N.Y. Yannaeva "Clinical and morphological parallels of hemodynamics of the uterus on the eve of childbirth with the nature of the course of the birth act" J. Post-Graduate Physician. 2008, No. 2, pp.123-130
26. "Zhukovsky ballon tamponade in the prevention and treatment of postpartum haemorrhage". Materials of XIV All-Russian Scientific Forum "Mother and Child". J. Effective pharmacotherapy. 2014, №11, pp.54-66
27. Y.G. Zhukovsky, I.I. Kukarskaya "Risk management: total control regime. Zhukovsky ballon tamponade and new obstetric practice" J. "Status Praesens". 2013, No. 3(14), pp.1-6
28. World Health Organization. WHO recommendations for the prevention and treatment of postpartum haemorrhage. Geneva: World Health Organization; 2014 [www.who.int](http://www.who.int).
29. World Health Organization. International Statistical Classification of Diseases and Related Health Problems 10th Revision 2010 Available at: [http://www.who.int/classifications/apps/icd/icd\\_10\\_online/](http://www.who.int/classifications/apps/icd/icd_10_online/)

## **LIGHT AND HEALTH**

**Prof. Dr. Christian Bartenbach**

*International Academy of Science H&E,*

*Innsbruck, München*

**1<sup>st</sup> Part**

**Abstract**

This paper discusses how the effect of light is related to health, well-being and diseases, of both a mental and physical nature. This not only concerns the optimisation of vision and the visual performance range, but also the “creation of knowledge” as a

harbinger of consciousness. Since most of the sensory stimuli that reach our brain are of a visual nature, this means that the processing of information inputs is mainly a visual activity. This processing and the associated visual behaviour is predominantly done in a neutral way through the “visual system” and hormonally through the “non-visual system”. These processes are explained and the associated research results, some of which have not yet been published, are presented. Results that predominantly concern the visual processes of perception also show the significance they would have if they were actually implemented. This also applies in particular to the “non-visual system”, in which the hormonal components that are influenced by light, i.e. serotonin and melatonin, are considered in conjunction with the circadian rhythm with regard to the implementation of daylighting and artificial lighting systems. This paper deals with a discussion about the complex effects the medium of light has on humans' visual and non-visual systems. This not only concerns good vision, but also the creation of knowledge, which is a prerequisite for raising awareness, and which in turn contributes to well-being and health. Light influences the human body, influences our sense of well-being and maintains our health. The term “health” is defined by the World Health Organization (WHO) as the state of complete

- physical
- mental-emotional, and
- social

well-being, and not only as the absence of illness and infirmity.

The brain's primary function concerns the “acquisition of knowledge” and it pursues this task through the “capacity to form concepts”, writes neurobiologist Semir Zeki. The essential foundation of this is the visual system as a source of sensory perception, as humans receive more information through eyesight, which is also part of our immediate visual field of activity. We are extremely dependent on our eyes and we live in a world that is largely adapted to being able to see. In fact, more than half of all sensory stimuli that reach our brain is of a visual nature, says Eric Kandel in his excellent book *The Age of Insight*. It is my understanding that the brain, with its visual conceptions, and in particular that of daylight, its course of time, the circadian rhythm that accompanies it, its quantity and distribution as well as the spectral composition and changes as the day goes by, and thus the visual information associated with it in the surrounding environment, has a significant influence on our behaviour.

In my use of language and in my texts, “good light” means that high visual acuity and visual performance are essential criteria for our lighting technology. In addition,

visual perception, i.e. recognition and the ability to pay attention and thus the expansion of what is conscious and unconscious, which in turn results from the processing of information in our brains, is a higher dimension and largely determines our behaviour. “Good vision” is important, but is only an attendant component in the visual system. If vision is good, the processing of this “foveal field of vision” occurs via the neuronal nervous system and serves primarily to convey information.

The neuronal processing occurs instantly. The visual system also adapts in order to meet varying visual conditions and copes with enormous differences in brightness during the day and at night, which range from  $E_{aSun} \sim 100,000 \text{ lx}$  in the direct sun to  $E_{aNight} \sim 0.1 \text{ lx}$  at night. Our visual organ is capable of adapting to these conditions and to continue seeing.

### **The visual system**

The visual system refers to the visual processes that humans have. Its components are:

- Visual performance
- Visual perception
- Attention
- Information processing

When we refer to the visual system, we are concerned with optimising visual performance and the necessary prerequisites that lead to “good vision”.

#### **The key factors here are:**

- The criteria of contrast sensitivity
- Adaptation processes
- The conditions of stable perception

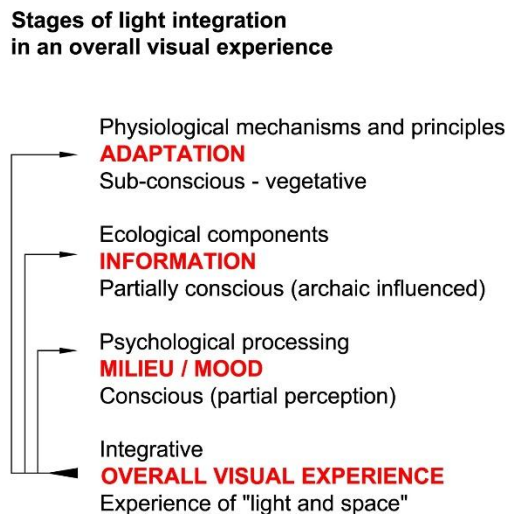
#### **Closely linked to this are:**

2. Luminance classification for the inner retinal and surrounding area in their visual field areas and their positioning

### 3. The significance of textures and colour and their position in the visual space

Since about 80 per cent of the information processed by humans is a result of visual perception, the visual system's autonomous processes are crucial for the determination of good vision.

The mechanisms and processes of involuntary and divided attention are largely autonomous and unconscious. They are almost exclusively influenced by the vegetative nervous system. In order to gain or increase knowledge, however, focused attention and the creation of consciousness are necessary.



**Fig.1. Stages of light integration in an overall visual experience**

The range of visual information is so large that it cannot all be processed at the same time, as perception and processing would become diffuse. Selective attention reduces this range of information so that it can be processed. The processes that lead to the optimisation of visual performance, i.e. “good vision”, are adaptation processes, stable states of perception, contrast sensitivity and visual acuity, etc., as opposed to the visual physiological components.

Flawless visual processes of optical perception as well as those of attention processes involving visual tasks and visual information are therefore prerequisites of well-being and health. This includes the influence of the spatial visual environment, with

its colours, textures, material surfaces and optical appearance. The resulting light and spatial environment has a significant influence on well-being. These relationships are shown in the following diagram (Fig.1).

Because the visual detection of an optical situation (space) is a complex mental process, it is necessary to approach the actual appearance of a space in several differentiated phases (Fig. 1).

This process can be dealt with in the reverse fashion as well, as in many cases spatial concepts and appearances are determined by the owners of buildings and their architects. In conceptualising lighting and spatial environments, it is important to realise that with visual perception and its processing operations, unconscious (autonomous) as well as conscious processes linked to awareness are involved. Mental duress leads to fatigue and stress and can make a space uncomfortable. This can be caused by inappropriate lighting, textures or colours, and can lead to an inappropriate lighting and spatial environment. In addition there are disturbances caused by glare, which can be physiologically caused, but above all also by distraction and a reduction of attention, which then influence the state of consciousness. One of the most important prerequisites is the balanced allocation of brightness for visual tasks.

These considerations are part of the visual system. In addition, there is a change in the hormonal balance, which is part of the non-visual system. As can be seen by looking at standards, the qualitative assessment of lighting is still based primarily on quantitative criteria. Although physiological components of vision are taken into account, they are not sufficient for us to have a true understanding of the complex process of visual perception. This is necessary, however, in order to obtain objective findings on the basis of which the lighting qualities of rooms can be assessed with regard to various requirements (use, activity, visual tasks). An essential aspect is therefore to incorporate the findings of visual perception into planning processes, especially in the design and creation of the lighting environment. For this reason, the focus in the design and creation of lighting environments should be on the aspect of visual perception.

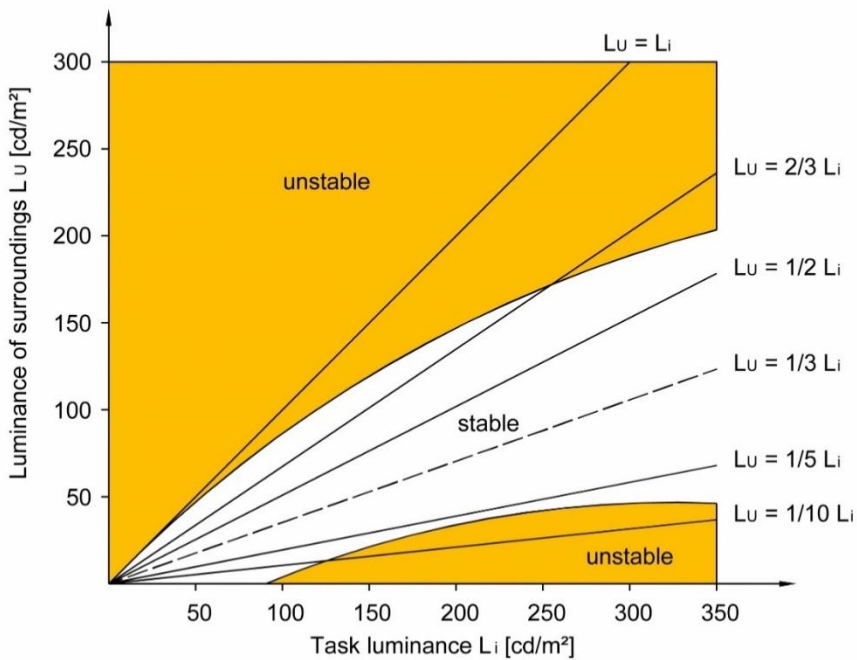
The individual components of the perception process can thus be used to extend the assessments of spatial appearance. The importance of design-related constraints such as colours, textures, materials and furnishings, etc. can be duly incorporated in order to be able to plan a holistic, integrative appearance on a visual basis. Through the neurophysiological mechanism of adaptation, the eye autonomously (for the most part unconsciously) adjusts its sensitivity to brightness in response to constantly changing light conditions in its field of vision.

Thus, fluctuations in brightness are seen as a largely invariant quantity. This is the primary prerequisite for a constant, i.e. relatively continuous, perception of space. The condition that brightness (L) becomes an invariant is the “constancy of brightness



through adaptation”. This range is considered to be achieved when the adaptation process has reached its final state under the given luminance conditions. In order to optimise the basic sensations of vision, and due to the changes that accompany active behaviour, it is necessary to stabilise the visual field of perception. The task area is surrounded by the spatial environment, which is visually included and defined by the field of vision. These relationships are shown in Figs. 2 and 3. The theoretical luminance model (Fig. 2) makes it possible to define an objective relationship between  $L_i$  (task luminance) and  $L_u$  (surroundings that need to be determined for the conception and implementation of the planning process).

### Task luminance vs. luminance of surroundings



**Fig. 2. Luminance ratios between task area and surroundings for stable visual conditions**

Interrelationships such as the ones shown above are frequently used in planning processes on actual projects, especially concerning office lighting (computer workstations). Tests carried out with many test persons (up to 40 people) have led to the recommended luminance ranges shown above and have also been described in a number

of articles. These results are shown in the series of images here, and the test methods used are shown in the table and Fig. 4.

These results clearly show that if the luminance distribution in a space is not within the stable range of perception, effects on a person's health can be expected, which will particularly impair people's well-being. The following models of optical perception and information processing were used as a basis for our research activities.

### Luminances (task luminance/luminance of surroundings)

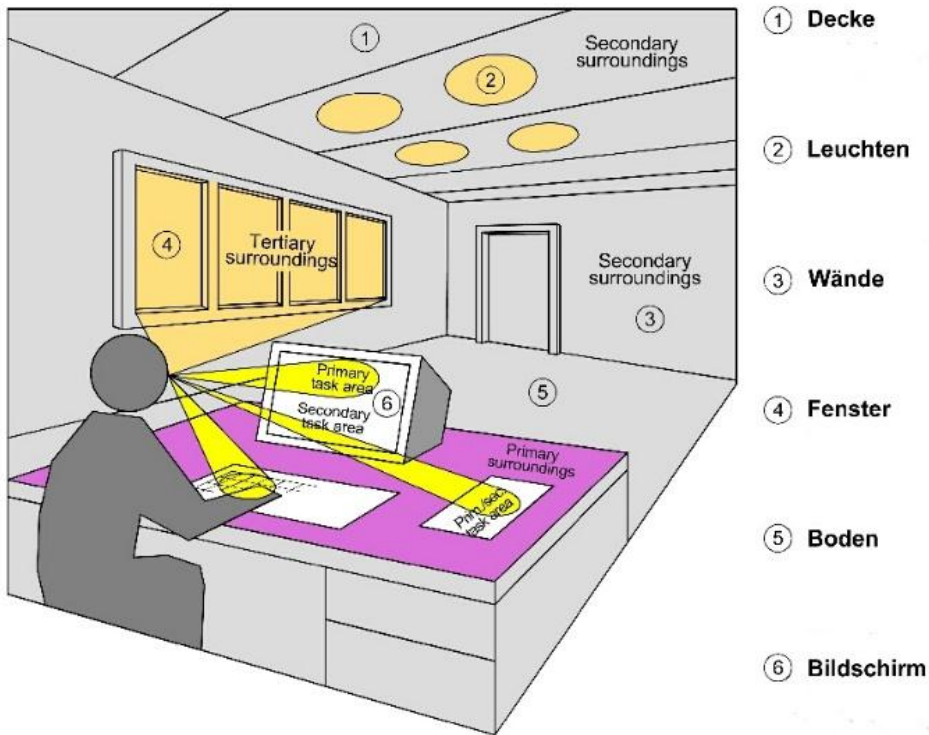


Fig. 3. Shows the ergonomically relevant structure of the visual field in its spatial sub-components using the example of a computer workstation

Test room:

Quantitative recording of psycho-physiological stress exposure under variable luminous ratios between task area and surroundings.

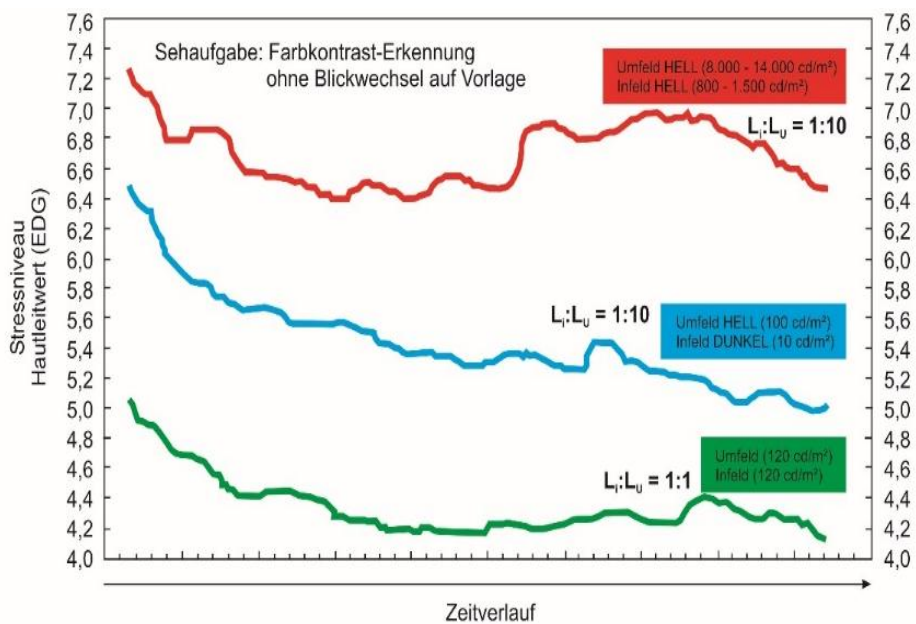


Fig. 4.

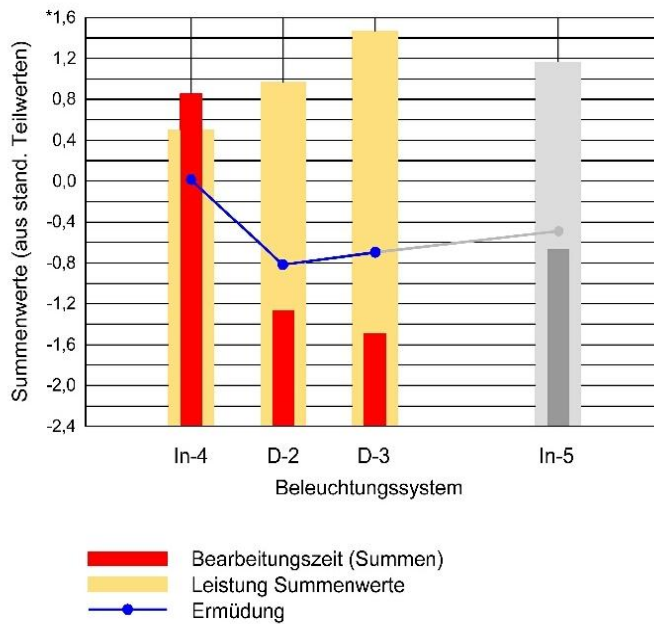
Fig.5.

More than 30 lighting variations based on performance and fatigue variables were compared and a total of approx. 1400 persons (random sampling) were tested.

Some of the results:



**Fig. 6. Ratio of  $L_i$  to  $L_u$ , based on skin conductance (stress level) over time**



\* Einer Skaleneinheit (0,1) entspricht ein Leistungszuwachs bzw. eine Leistungsabnahme von 1.08



**Fig. 7.**

**Visual performance subject to visual performance, fatigue and processing time, using the criterion of lighting systems. The indirect system is to high ambient luminance unfavourable**

In-4 Floor lamps, indirect distribution  
 D-2 Round ceiling lamps, direct distribution  
 D-3 Specular louvre lights, direct distribution

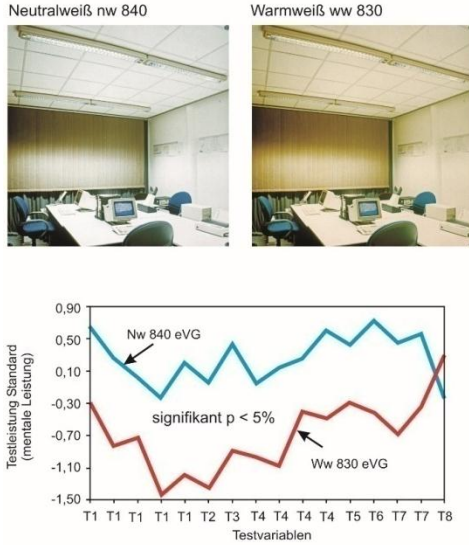


Fig. 8.

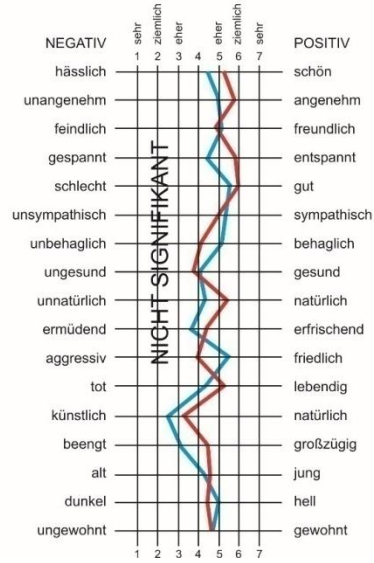


Fig. 9.

Dependence of visual performance on the colour locations. The results of these tests show (Fig. 8) that with objective methods of measurement, higher colour locations at computer workstations lead to significantly higher visual performance (objective test). The subjective test methods (surveys – semantic differential) allow us to make no significant statement, as shown in Fig. 9.

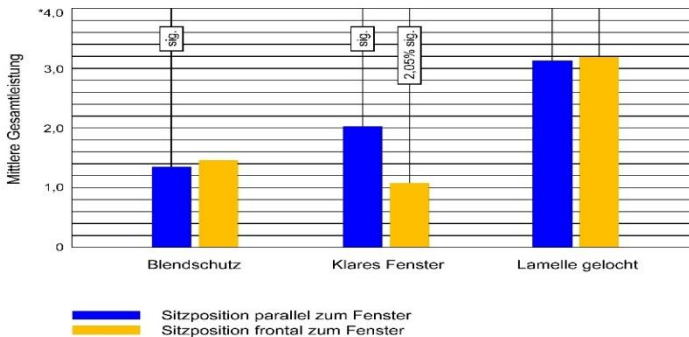


Fig.10.

1 Glare protection: Side window with screen (principle of shading)

## **2 Clear window**

### **3 Deflection vein: Mirror reflector elements and sun protection with ambient luminance (principle of light deflection)**

This assessment shows that, despite the high absolute TQ due to the high luminance of the window's surface (outside world), the clear window has similar values to the shaded window, which receives low task area values but also indicates a low self-luminance of the system. The window with the deflection system shows sufficient task area brightness of TQ ~ 3 per cent, which is lower than the values of the clear window but still has a luminance of 200 to 300 cd/m<sup>2</sup> of the window – which corresponds to the range of stable perception (the system was developed for this purpose) and thus shows the highest mental performance and least amount of fatigue.

### **Summary of visual performance, the visual system**

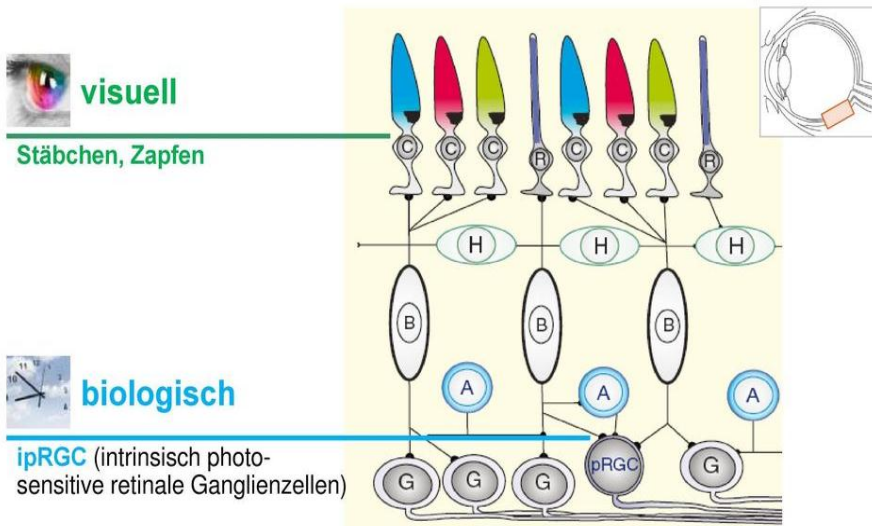
Visual performance is largely networked with the "autonomous processes" that control our visual processes. Through the focused area, the task area, the directed attention processes and awareness is stimulated. As far as the processes of "conscious-unconscious" can be generally separated, and whether the emergence of states of consciousness occurs abruptly, i.e. is a threshold phenomenon or whether there is a smooth transition between unconscious and conscious states, is unclear (the neurologist Gerhard Roth says he thinks the latter is probable). One can assign criteria of stable perceptual processes to the autonomous visual process. They form the basis for optimising the visual performance and are also the basis for creating a lighting and room environment that is appropriate to the task and supports well-being and health.

### **The non-visual system**

The non-visual system (timing system) has another purpose. It measures the slow fluctuations in luminance during the day and at night and reacts to the retina's "photosensitive ganglion cells", which are able to absorb light as an independent type of receptor. They are distributed over the entire retina and have the largest receptive fields in the retina, enabling them to efficiently collect light that provides information about light and darkness. They also receive input from the cones and rods and are thus part of the "visual system", and contain the light absorbing pigment melanopsin.

The photosensitive ganglion cells, which were first discovered in the last decade, act as a third type of photoreceptor alongside the cones and rods. They react in a less sensitive way and are much slower to light stimuli than the cones and rods' visual system, making them unsuitable for image processing. They are, however, able to continuously respond to constant exposure, but only that with high intensity (daylight).

This distinguishes the photosensitive ganglion cells, the third type of receptor, from the cells of the visual system (cones and rods) and they process and act differently as well, making them part of a non-visual system. These photosensitive ganglion cells are connected to the SNC (nucleus suprachiasmaticus, i.e. the inner clock), which monitors the circadian rhythm of the body as a central timer.



**Fig. 11 Visual and non-visual effects are based on different receptors**  
(Source: Osram)

It has been determined, that circadian rhythms such as...

- sleeping - waking
- rest - activity
- influence on hormone control such as melatonin, serotonin, cortisone
- digestion-detoxification
- ultradian rhythm such as, e.g. breathing, heart, brain activity
- infradian rhythm, such as weeks, months, years, daily

...are controlled by this central internal clock (SNC). Since each cell has an internal clock and we consist of trillions of cells that have corresponding rhythms according to their functionally determined area, they are controlled and synchronised by the central clock (SNC). Just as a conductor leads his orchestra and acts as the timer, light via the SNC acts as a timer for our inner clock. Bright light is one of the strongest timers. Especially daylight, with its rhythm, its distribution and its changes. The light that enters the eye is decisive, i.e. the vertical illuminance at the eye ( $E_{VA}$ ), which is the criterion

for the light flux that enters the eye. The question arises as to what is connected to the term “bright light” that is necessary to activate and bring to bear the third photoreceptors (photoreceptive ganglion cells), which serve as the basis of the non-visual system and the circadian rhythm? This is extremely important for the planning process, as knowledge about quantity and type of light used to achieve the desired effect is necessary and can be defined to a large extent. Since it seems to be essential as shown by research results and other chronobiological activities, that “light with sufficient brightness and a suitable spectrum” is available, according to daylight and its changes throughout the day, the circadian rhythm that occurs in our buildings – is stabilised by our inner clock and the timers. Daylight is the strongest and most important timer, but there are other strong timers inside buildings, other people and structures during the daily routine, such as a regular daily routine with fixed times for...

work – social contact – leisure activities – meals, etc.

These structures of time information keep our “inner clock” stable, in a 24-hour time rhythm. Regarding the internal clock (SNC), chrono biologists also see the central control of a higher-level pacesetter, whose primary task is to...

- repeatedly coordinate the complex human organism and the inner clock it has for its cell structure
- synchronise the inner clock with the outside world, e.g. every morning this pacesetter receives time signals (like a radio-controlled clock) via the timers in order to synchronise, e.g. switching to active during the day and less active during the night
- prevent disruptions: in the case of long-lasting disruptions, it once again begins to coordinate things with the external world
- prepare for upcoming events, e.g. during sleep to prepare for the “waking state” in the morning.

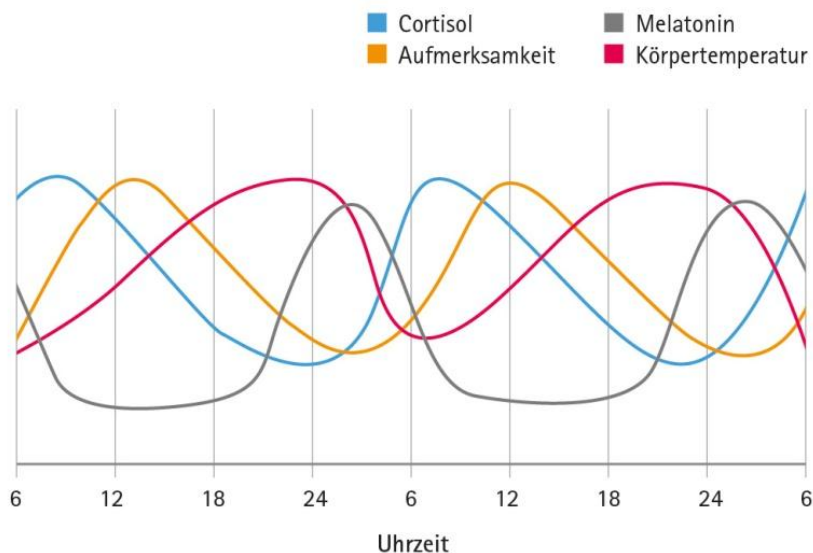
And thus, the foundation for the optimisation of the non-visual system and therefore for well-being and health has been laid. It can also be said that health will be influenced if internal or external harmony and order are inhibited by physical, mental or social processes.

In real terms, this means a corresponding expansion of the design of daylighting and artificial lighting, and the resulting requirement with regards to the type of daylighting openings (e.g. skylights) there should be with daylighting systems and the necessary building structure that “lighting design” requires.

The SCN (suprachiasmatic nucleus) is the anatomical domicile of the biological clock. It checks and coordinates, together with a semi-autonomous system *with inner*



*organ clocks*, numerous daily rhythms, “vegetative functions” and the hormonal blood level using a hierarchically structured system.



**Fig.12. Circadian rhythms of cortisol, melatonin, attention and body temperature**

The rhythms shown in Fig. 12 modify sensations and states of mind, and thus form the basis for daily rhythmic patterns of behaviour (Ehreinstejn). Synchronising factors in the environment are called timers, and as already mentioned, the decisive human timer is daylight and the rhythm inherent in it.

## 2<sup>nd</sup> Part

### Serotonin

Serotonin mainly works in the limbic system. This is the part of the brain that is responsible for our mood and emotional memory. Serotonin elevates feelings of well-being and has a stimulating effect, hence the name “happy hormone”. Serotonin is a neurotransmitter (biochemical substances that pass information from one nerve cell to another) that functions in the central nervous system, intestines, cardiovascular system

and blood. We know that one of the factors that causes the production of serotonin in our bodies is light – sunlight and other forms of daylight.

Even artificial light of a certain quantity and quality (spectrum) can achieve this effect. Because too little light leads to a deficiency of serotonin, depression can occur (an indisputable fact). This is also the reason why light therapy is used to improve light deficiency and successfully prevent any subsequent depression. An American study carried out in sunny San Diego (Russell J. Reiter 1994) shows how little time we actually spend outdoors.

On average, middle-aged adults spend about 4% of their time outside, and about half of this is in cars, so that most people spend 97 to 98% of their time indoors. Because a daylight factor of  $DF = 2$  to 3% is considered to be an adequate amount of daylight indoors (only visual performance is usually taken into account here), we usually find ourselves in a twilight-like atmosphere. Although this is enough for good vision, it does not satisfy the requirements of non-visual systems, as shown in Fig. 13. This figure shows the external brightness during the day in comparison to the typical amount of light indoors.

### **Illustration of real daylight situations**

Quantitative criteria developed for visual systems in real applications amount to approximately  $DF = 2\%$  for office work during the day. If this level of brightness is not sufficient for the immediate activity, it is supplemented with artificial light. With regard to distribution, the term “daylight factor” is based on a standardised, diffuse overcast sky that varies with respect to brightness over the course of a day and year, and to the meteorological process.

People generally live in rooms that only have a fraction of the amount of light (2 to 4%) found outside. We create a kind of twilight that is usually sufficient for the necessary visual performance, but the rooms are not as transparent as rooms full of daylight would be.

The consequences of this are that light therapy is used if symptoms of depression occur. It is necessary, however, to design the light and atmosphere of rooms in a way that daylight allows for the production of enough serotonin so that light therapy is not necessary in the first place.

The absolute brightness of daylight outdoors, its temporal change, its scenarios and the way it is transmitted to the interior rooms all have a great influence on the light and atmosphere of indoor spaces and thus on our well-being and health. As can be seen in the diagrams in Fig. 13, there is certainly a sufficient amount of daylight in our world.

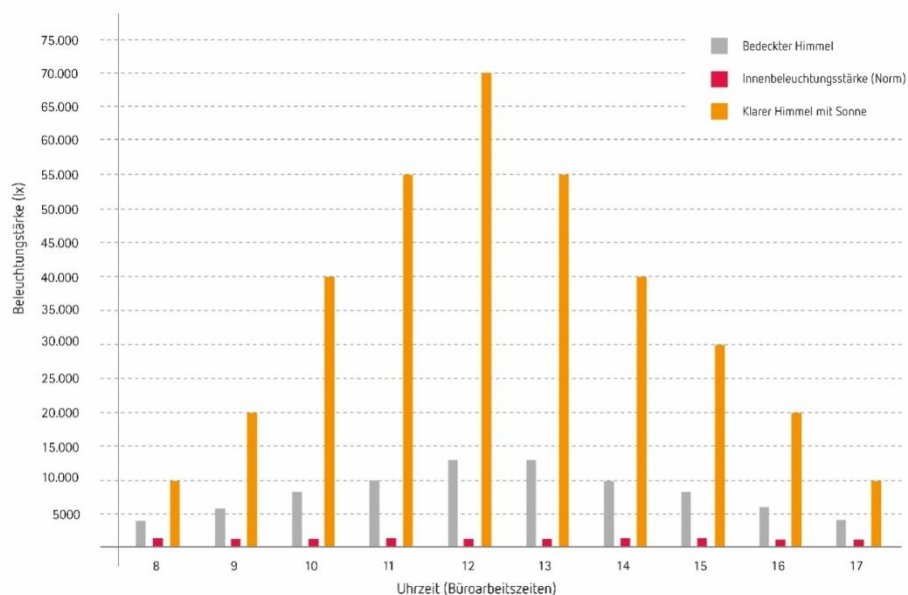
It is available to us free of charge and we are biologically adapted to it. It is, however, urgently necessary to bring it into our rooms at the right time and in sufficient amounts.

Our concern as lighting designers should be that the level of daylight and artificial light inside buildings be of such quality that the interior environment harmonises with the production of serotonin, making any additional light therapy unnecessary. That is the goal. This raises the question of which visual criteria we apply and how they have to be designed to meet the requirements.

Visual criteria for the support of serotonin production:

- Amount of light
- Effective duration of light
- Spectral composition

Visual conditions for the optimisation process of visual performance and well-being



**Fig. 13. Table from the book *Melatonin* by Russel J. Reiter, p. 229**

Research carried out by the Lichtlabor Bartenbach, the Competence Centre and the University of Innsbruck – (psychiatry) professor Hinterhuber, have determined that the levels of luminescence necessary for the production of serotonin are, for example:

- 2500 lx over a period of 2 hours

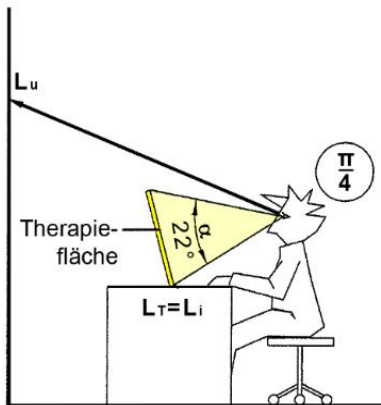
- 5000 lx over a period of 1 hour

This corresponds to luminescence of  $L = 3000 \text{ cd/m}^2$ , which can be achieved by using small area light therapy devices, Fig. 14 (general recommendation). If you want to distribute the lighting level over an entire room, the spatial angle (field of view) increases many times over (approx  $\pi$ ) and the brightness supporting the production of serotonin becomes considerably less but much more feasible. Such a visual space becomes therapy simply due to its “new brightness”. Planning processes require that all necessary luminance values be very precise, as they have a great influence on determining the amount of light and its distribution within a space, and thus significantly influence the location and geometry of openings that allow daylight in. This is one of the main requirements of designing a space. The hypothetical assumption is that if brightness supports or enables serotonin production, while considering the spectrum and the effective duration of light, then this is also sufficient for maintaining the circadian rhythm.

Three studies were carried out. Common to all three were the ranges of luminance ( $L_{um}$ ) to be tested:

- 1<sup>st</sup> test series 80 - 1500  $\text{cd/m}^2$
- 2<sup>nd</sup> test series 33 - 130 - 1462  $\text{cd/m}^2$
- 3<sup>rd</sup> test series 11 - 274 - 770  $\text{cd/m}^2$

Description of the procedure:





**Fig.15**



**Fig.14**

Tryptophan depletion (TD), an established method of influencing the serotonergic system and mood, was carried out. The purpose of this study was to assess the effect of the TD under different light conditions using serotonin – associated plasma levels and a visual analogue scale (vAS), measured in healthy women. 215 female students were recruited by the Medical Faculty in Innsbruck (report reference). The results of these studies concerning an increase in serotonin are shown in Fig. 17.

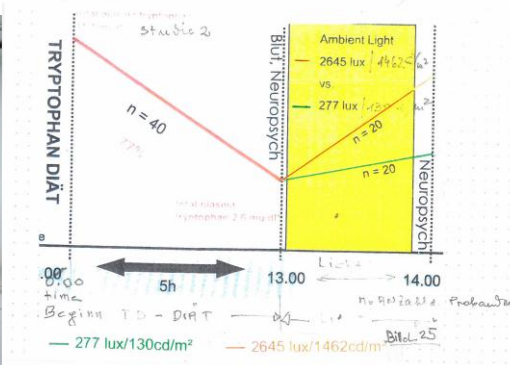
#### Design of the 1<sup>st</sup> and 2<sup>nd</sup> test series

In such seating positions (arrangement) the field of vision has a spatial angle of  $\square \square \sim 1,26 \times \pi$ , and in the visual process of perception, visual field luminance (ambient luminance) has an average  $L_{um}$  value. This indicates that after the test subjects had had a five hour tryptophan diet, exposure to light caused a serotonin increase at  $L_{um} = 130$   $cd/m^2$  (Fig. 17).

In summary, the results of all three studies showed that ambient light (average ambient or visual field luminance in  $cd/m^2$ ) of  $L_{um} = 11 - 1500$   $cd/m^2$  shows a significant influence on cerebral serotonergic systems. In addition, the results (Fig.17) indicate that bright ambient light can have a positive effect on mood, even with lower brightness levels than those recommended in conventional light therapy (2500 lx/10,000 lx).



**Fig. 16**



**Fig.17**

It was found that bright light is not only more effective than dimmed light (80 cd/m<sup>2</sup>) in improving dysthemia (circadian rhythm disorder) after a tryptophan diet, but is also effective for other emotional and cognitive functions.

The results of Fig. 17 show that a serotonin increase occurs even at  $L_{um} \sim 130 \text{ cd/m}^2$ . These investigations were carried out in a joint KPZ research project at the University of Innsbruck (psychiatry), headed both by professor Hinterhuber and Bartenbach.

Tendencies indicate that serotonin production occurs even at lower ambient luminance levels than are generally recommended for bright light. If we consider that the length of stay indoors is usually 3 to 4 hours and that our daily rhythms are caused by different intensities of brightness, distributions and appearances, it is often possible to achieve sufficient brightness at geographical locations at peak times of the day and year.

As can be seen from the results of another study, a significant increase in serotonin production even occurs at  $L_{um} \sim 270 \text{ cd/m}^2$ . These results are significant and allow us to conclude that not only do brightness levels of  $L_{um} \sim 130 - 1.500 \text{ cd/m}^2$  over a two-hour period of time spent inside not only enable and support serotonin production, but are also a prerequisite for maintaining and facilitating circadian rhythms. They thus have an effect on the autonomic nervous system as well as on our mood, well-being and health. When planning a daylight environment, it makes sense to ensure that the luminance ranges, which can change according to external brightness (circadian rhythm), are within the range of the theoretical luminance model, thus synchronising the visual and non-visual systems.

As serotonin production begins in the morning, it is a good idea to consider this in the planning process and make it possible early in the day. Experience has shown that the level of serotonin will last an entire day, and is also the prerequisite for subsequent melatonin production. Because the time required for serotonin production with higher

average luminance should be approximately 1 to 2 hours, room environment scenarios can be limited to this period of time. Projects have already been carried out based on these findings. The system illustrated in Fig. 18 has been optimised with the use of a daylighting system – a 30° specular reflector and sun protection system with a double curtain. Synchronisation is possible but task area brightness, especially in the middle of this large room, requires extra artificial light on overcast days.



**Fig. 18 (BMW headquarters Munich).**



**Fig. 19 (Deutsche Bank Berlin)**

In this spatial environment (Fig. 18) visual performance is sufficient as the amount of daylight is more than  $DF = 3\%$  and the distribution of daylight corresponds to the visual tasks. Artificial light is used when required, glare and distraction do not occur here. The amount of daylight is not enough to ensure serotonin production. The circadian rhythm is supported by a change in external brightness, especially in the room in Fig. 19. The amount of light can be partially increased through use of the sun (Fig. 19), supporting both serotonin production and the circadian rhythm, whereby synchronisation is achieved during the period of possible sunshine duration (solar use). In summary, it can be stated that in the case of buildings that have external light coming in from the side, if the necessary prerequisites are met, the goal of a synchronisation of visual and non-visual systems with complementary daylighting is generally possible.

## **Melatonin**

### General:

Melatonin is a metabolic product of serotonin. It is known as a sleep hormone and is mainly produced in the pineal gland. The production of melatonin is primarily influenced by the light that humans absorb through their eyes. As a metabolic product, melatonin is produced during the night and serves to help people fall asleep as well as regulate bodily functions during sleep. Bright, full spectrum light that hits the retina triggers a signal that inhibits the release of melatonin. Melatonin deficiency causes sleep disorders, weakens the immune system and reduces regeneration at night. A major American study was made that investigated approximately 150,000 nurses who work the night shift under artificial light. It was found that the production of melatonin was reduced and that colon and breast cancer increased by approximately 35%.

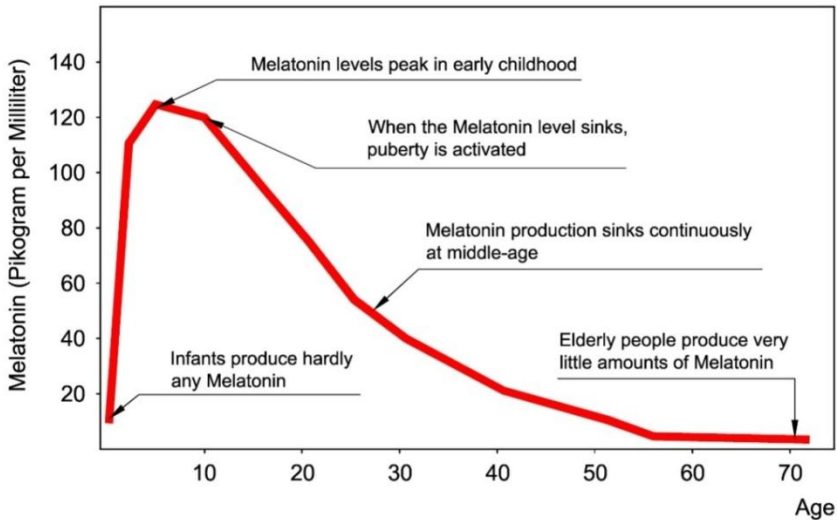
It is believed that during the night melatonin...

- protects against cancer (captures free radicals)
- protects against Alzheimer's
- prevents strokes and heart attacks (blood clots are prevented)
- activates the immune system
- inactivates the reproductive system
- promotes regeneration through sleep
- acts as an antioxidant

The maximum secretion of melatonin occurs between the ages of one and thirteen. Melatonin production in the pineal gland decreases by approximately 80% when adulthood is reached. Melatonin is sometimes referred to as a youth or growth hormone. Gerontological researchers assume that this hormone delays biological ageing and has a life-prolonging effect. During the months when there is little light, the body does not break down excess melatonin sufficiently during the day. This leads to a disturbance of the sleep-wake cycle. At high levels of brightness, melatonin production is abruptly suppressed. This suppression during the day is, as mentioned above, important. According to research, this would otherwise lead to too much melatonin or melatonin that has been secreted for too long during the day, which would negatively influence winter depression and would also influence the stability of the circadian rhythm. It also appears to be important that enough serotonin be available during the day, because, as already described, it is an essential component for the production of melatonin. As mentioned, the circadian rhythm is one of the prerequisites for the functioning of the non-visual system.



## Melatonin production depending on age



**Fig. 20. Melatonin production depending on age (source: Russel J. Reiter, *Melatonin*, University of Texas, USA)**

The light-dark cycle's connection to the outside world is through the eyes, which are a source of sensory input to the nerve pathways, whose origin is in the retina and through the SNC to the pineal gland. This is also the most important producer of the hormone melatonin. It is the body's own signal for the night. White light, and especially that with a full spectrum, triggers signals that inhibit the release of melatonin. The pineal gland is not only the producer, but also the mediator between the circadian rhythm and the endocrine functions that secrete hormones in our blood and organism. Almost all the body's cells are informed by the level of melatonin in the blood with regard to when the day ends, and when the next morning begins. Melatonin primarily controls our biological clock and is one of the essential prerequisites of our circadian rhythm and our health. In order to integrate this general consideration of the handling and implementation of the non-visual system in the planning process, a number of questions must be answered, making research and development necessary.

## **Lighting effect and melatonin production**

The effect light has on the production of melatonin depends on its intensity, its distribution in an interior space and the vertical illumination of the eye, as well as on the spectral composition of the light that reaches the eye and the course of time, as light intensities and spectra fluctuate according to the time of day and year. Using the sensitivity curves of the photopic, scotopic and circadian processes, the melatonin retention function was worked out and shown in Fig. 24. It is also the case that the effective spectral distribution on which the colour location is based, is generated in a room through the spectrum of the light source, the types of reflections (indicator matrix) of the material surfaces on the walls and the type of multiple reflections. It is, however, mainly during daylight that the change in time according to the dynamic equilibrium is taken into account. The general prerequisites and level of knowledge about melatonin as a basis were developed in detail in a research project (KPZ 35) carried out by Bartenbach Lichtlabor's Austrian Competence Center together with the UMIT in Hall, professors Schobersberger and Hoffmann. The objective was to define the spectral progressions with sufficient brightness at night and at the same time to enable visual performance using a lighting system or light source whose spectral distribution on the eye maintains the production of melatonin. The multiple reflections in the room, their reflection values and reflectance properties as influenced by a steady state were all taken into account regarding how they determine the eye's colour location. With these requirements in mind, two test rooms were set up, whereby Test Room 1 (V1) was illuminated with melatonin light, while Test Room 2 (V2) was illuminated with white light. With the exception of the differentiated spectra, both rooms had the same lighting indicators and technology, and the same visual activities (Fig.22). The spectra that are appropriate for use are shown in Fig. 24 as an example.

### **Day and night work study**

Test Room 1

spectrum melatonin light (Fig. 21)

$T_K \sim 2500 \text{ K}$

LED light sources "test light"



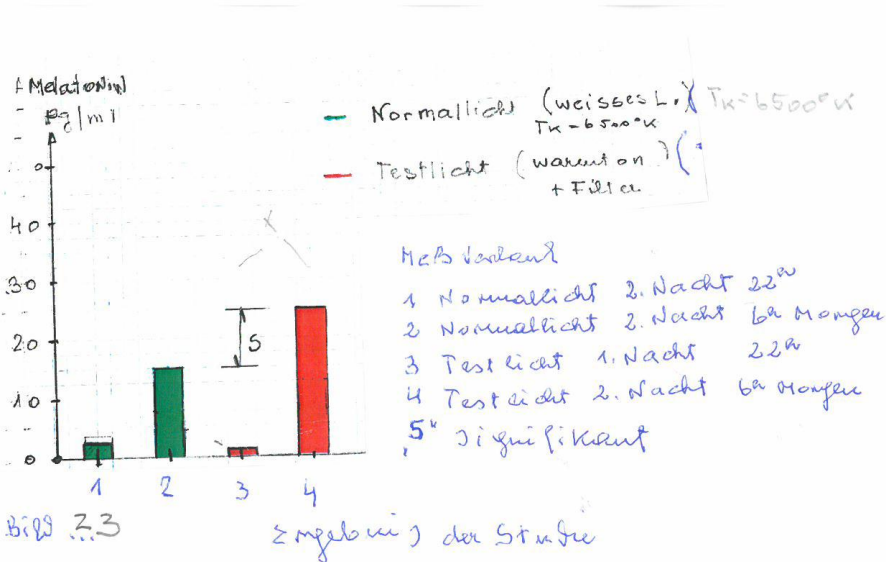
**Fig. 21.**

The spectral distribution in the colour location  $T_K 2500^\circ K$  is shown in Fig. – The LED light source, spectral absorption in the range of possible melatonin production enhances spectral distribution.

- Test Room 2
- white light, spectrum -
- fluorescent light  $T_K \sim 6300K$
- normal light



**Fig. 22.**



**Fig. 23. Measurement process:**

1. Normal light 2<sup>nd</sup> night 10 pm
2. Normal light 2<sup>nd</sup> night 6am (morning)
3. Test light 1<sup>st</sup> night 10 pm
4. Test light 2<sup>nd</sup> night 6am (morning)
5. Significant

The results of this extensive research, which was carried out during the night and used high light intensity ( $E_v = 800 \text{ lx}$  and  $L_{um} = 310 \text{ cd/m}^2$ ) was that in Test Room 1 with the melatonin light, production of melatonin was maintained to a significant degree. In Test Room 2 with the fluorescent lights and a colour temperature of 6300 K, the production of melatonin was greatly reduced (Fig. 23). Performance tests (visual system) were carried out during a simulated night shift. With neither the visual perceptual performance nor the processing of cognitive information and motor response organisation was there any significant difference between the test lights and full-spectrum normal lights. As described above, the production of melatonin in Test Room 2 was reduced. The spectral distribution of a light source that corresponds to melatonin light can be determined from the so-called melatonin suppression/maintenance curve (Fig. 24).

It should be noted, however, that...

4. it is objectively possible to maintain melatonin production in the intensity range of  $L_i = 80 - 300 \text{ cd/m}^2$  and  $L_u = 15 - 75 \text{ cd/m}^2$
5. the spectral transitions that lead to night or rather melatonin light brought about by daylight, daylight supplementary lighting and the transition to artificial light need to be objectively determined
6. the visual forms of behaviour in question need to be objectively analysed
7. luminance ratios (with their accompanying technical lighting codes) and the spectral progressions that occur in the circadian rhythm over the course of time and with transitions need to be determined and the melatonin light associated with this process is to be tested comprehensively with regards to its feasibility of production
8. the acceptance of such light in room environments needs to be subjectively investigated, as melatonin light produces unfamiliar light and room environments due to its low blue content and low colour location. Temporal and spectral transitions for behavioural aspects of acceptance (appearance) are therefore dominant.

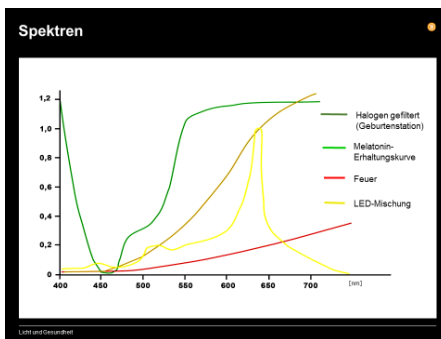
### **The determination of melatonin-maintaining spectra**

#### **Method:**

The melatonin suppression curve (Fig. 24) serves as the theoretical starting point, and acts as a base for designing a melatonin maintenance curve. There is a relatively wide range below 2500 K to 1500 K, and especially below 2000 K, where no reduction in melatonin is indicated. The spectra used in Test Room 1 have already shown that melatonin production is present even at high intensities of  $E_v = 800 \text{ lx}$  und  $L_u = 310 \text{ cd/m}^2$ . If the stipulation to maintain melatonin production is met, melatonin light will exclusively or consistently become night light, meaning that the basic principles of good lighting design, as already mentioned above, must be observed. This means that so-called “night light”, during which the various activities at night occur, must also ensure high visual performance, while making relaxation and well-being possible as well. According to the biological process that takes place in the circadian rhythm, humans should sleep at night and regenerate themselves in the process. In our society, however, this is no longer possible to this extent, as night has literally been turned into day. Artificial light is now used for all night-time activities. Up to the 19th century, fire provided light, but today there is a wide variety of light sources. We have to be aware of the fact that night light is human-made artificiality. It is similar to a tool that has been changed or improved over time. Fire, the oldest and longest-used light source, has accompanying phenomena such as warmth, comfort, closeness, and well-being (light as a tool). This type of night light does not inhibit melatonin production. It would thus make sense to determine the appearance of the different spectra at such low colour temperatures and the associated notions of appearance, especially as visual performance

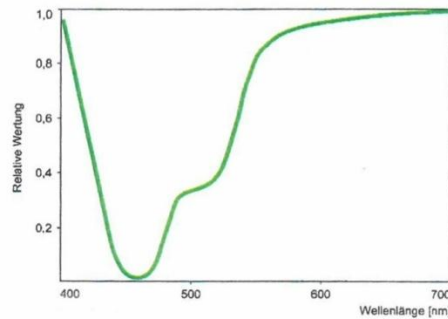
and diverse lighting and room environments are also determined by such requirements. This shows that it is possible to determine a spectral range that is suitable for the corresponding intensities of light (visual power) while also maintaining melatonin levels. When designing a melatonin-preserving light milieu, the following criteria must be taken into account:

2.  $L_i/L_u$  intensity / distribution / visual performance – objective
3. state of mind / well-being / HRV
4. adjustment processes
5. acceptance – subjective



**Fig. 24**

**Possible spectral range for the lightspectra melatonin maintenance functions.**



**Fig. 24**

**Melatonin maintenance function, that can be used to maintain melatonin production can be derived from this.**

### Possible applications

Night light, whose spectral range should be within the melatonin maintenance curve shown in Fig. 24, will be a continuous spectrum and have a colour temperature of 2000K +/- 300K (hypothesis). From the results of the studies, as mentioned above, it could be concluded that using such colour temperatures and suitable spectral progressions, a light and room environment could be created that will be both objectively (sustainably) and subjectively accepted. The change from daylight to night light is, if not made abruptly, unproblematic.

Room surfaces using the reference colour white objectively show no significant HRV differences at colour temperatures of 3000/4000/6500 K. Subjectively, more pleasant properties were assigned to the test rooms using 3000 K. This also emerges from an interview of the test subjects with melatonin light. Similar results can be found in the studies of night shift work. This study of night shift work is also based on findings

that light environments with low colour temperatures were broadly accepted and were in this case also desirable. For the application in general, it becomes clear that the respective activities and usage processes can be attributed to the correspondingly necessary optimised visual services.

It is therefore essential when conceptualising night light that the spectrally critical range is designed using wavelengths between 450 and 550 nm, so that even at intensities of  $L_{\max} = 250 \text{ cd/m}^2$  melatonin production is maintained. In addition, the areas of activity that determine the task area  $L_t$  are not only adapted in intensity, but also spatially zoned and thus differentiated accordingly. The task area is a maximum of  $20^\circ$  of the visual field of the fovea, which is about 2 to 3% of the entire visual field. Of great importance for the formation of a sensitivity to differences and for focused attention is, however, the medium environmental impact, which a majority of the visual field covers, and which is thus decisive for one's state of mind when designing a lighting and room environment. The relationship between ambient luminance, colour temperature, texture, colour, form and the features of the light sources or the light system must be understood as a whole. As a guideline for system development, it is certainly necessary to take the spectral possibilities of this system into account in such a way that they correspond, for example, to the spectrum illustrated in Fig. 24. While with such concepts, visual performance (UE) and directed attention should be maintained if possible while using night light, the entire appearance of the room is changed. In time, through the use of chromatic adaptation (especially with white room surfaces), familiarisation and acceptance will grow. As such adaptation processes must be optimised and allow for many possibilities, as shown in figure 24, it is necessary to determine this spectral range through psychological experiments on both an objective (HRV) and subjective basis (semantic differential).

System conception for separate functions is:

- direct lighting systems with  $2 \times 30^\circ$  (LED) with system luminances ( $L_{\max} = 80 \text{ cd/m}^2$ ) that occur outside the distribution cone, reflective with adjustable optics
- equipped with a basic spectrum for the maintenance of melatonin
- wallwasher LED
  - with direct wallwash
  - in zonal areas
  - with additive overlay
  - determinable (different size spaces)
  - adjustable intensities
  - self-illuminance outside of distribution cone ( $L_u = 40\text{-}80 \text{ cd/m}^2$ )
  - basic spectrum for the maintenance of melatonin

- variation of blue proportion
- spectral adaptation to the surface of materials
- control

In summary, it can be said that light inhibits nocturnal melatonin production.

The main objective is to develop a light spectrum that does not impair melatonin production and that satisfactorily meets the visual requirements such as:

6. visual performance (UE = directed attention)
7. well-being and health aspects (HRV), 8. acceptance of the resulting spatial environment for the visual area of work and living.

If one takes into account the general trend and thus also the importance of the melatonin hormone, it can then be assumed that in future melatonin production should be maintained during the night. This means that artificial light at night will be used in an integrated way as melatonin-maintaining light. Since human activities at night are many-faceted, the optimisation of visual performance and maintenance of directed attention is important. And therefore the range of task area luminance with  $L_i = 80 - 300$  cd/m<sup>2</sup> and ambient luminance with  $L_u = 15 - 80$  cd/m<sup>2</sup> was adopted from the research results. The spectral distribution of the spectrum that falls on the eye and, above all, the environment ( $L_{um}$ ) that surrounds the visual field has a significant influence on mood; within the space these are the room-defining reflective room surfaces.

This realisation is based on the results of research work, but is at this time not sufficient for the development of a sound planning framework or products. It is therefore a goal to create melatonin light whose spectral distribution maintains melatonin production at night (night light), while permitting the necessary luminance ranges ( $L_i = 80 - 300$  cd/m<sup>2</sup>  $L_u = 15 - 80$  cd/m<sup>2</sup>).

This makes it possible to design light and room environments that have optimal visual conditions of perception and directed attention. As far as sensitivity is concerned, it is important to set the colour temperature at the eyes, which is mainly caused by steady state equilibrium and the modulation of light on the surfaces of the immediate environment, as this increases the objective criterion of HRV and supports parasympathetic processes.

The effect of the sensitivity of the mean ambient luminance  $L_{um}$ , which is a result of the entire surrounding visual field, can be evaluated using the HRV criterion. This mainly influences mood and thus well-being. The luminance ranges are dominated by  $L_{um}$ .



## References

1. Christian Bartenbach / Walter Witting - Fundamentals of Photometric and Perceptual Psychology
2. Bartenbach / Competence Centre KPZ - Project No. P1009 The Influence of daylight and
3. artificial light on office workstations" (sunspace)
4. Bartenbach / UMIT Hall / KPZ- Project No. 35 The influence of light and light colour on mood, physiology and work performance during the day and night
5. Bartenbach / UMIT Hall / KPZ- Project No. 131 Health-oriented lighting applications in tourism and at leisure facilities
6. Bartenbach / University of Innsbruck (psychiatry)
7. Professor Hinterhuber / KPZ
8. Project No. 130 The therapeutic and non-therapeutic effects of light
9. E. Kandl - The Age of Insight
10. G. Roth - Das Gehirn und seine Wirklichkeit
11. R.J. Reiter / J. Robinson - Melatonin
12. D.L. Schacter - Searching for Memory
13. S. Zeki - Splendors and Miseries of the Brain
14. J. Zulley / B. Knab - Unsere innere Uhr Aldrans, März 2018

## EFFECTS OF SYSTEMIC HYPERTHERMIA ON EXERCISE PERFORMANCE, ENDOCRINE STATUS AND QUALITY OF LIFE IN HEALTHY UNTRAINED VOLUNTEERS

Oleg S. Glazachev<sup>1,2</sup>, Maxim A. Zapara<sup>1</sup>

<sup>1</sup>*I.M. Sechenov First Moscow State Medical University (Sechenov University), Moscow, Russia*

<sup>2</sup>*International Academy of Science (Health & Ecology E.v.), Russian Section*

**Key words:** *passive systemic hyperthermia, adaptation, increased BDNF, quality of life, exercise performance, multimodal rehabilitation programs*

## Introduction

The modern medical model mainly focuses on one-sided nosological diagnosis. The influence of socioeconomic status, quality of life (QOL), functional activity, premorbid personal characteristics, mental health, compensatory resources on objective and subjective indicators of physical and mental human health are not taken into account. At the same time, to maintain a high quality of life, only the availability of drug supply is absolutely not enough. A number of systematic studies have shown that

combined course of individually prescribed physical activities, physiotherapy techniques, psycho-trainings, as well as patient education in controlling risk factors for chronic diseases in the form of multimodal rehabilitation programs (MRP) is the most effective approach to the rehabilitation and maintenance of QOL. One of such approaches in the development of MRP is the implementation of the principles of adaptive medicine. Adaptive medicine is a direction that studies human adaptive abilities to environmental stressors, and also develops methods and means to improve these capabilities, functional reserves and QOL [7, 8]. The principles of adaptation medicine (induction of adaptation direct and cross-effects) are the basis for a number of well-known and recently introduced new approaches to improving the health reserves and QOL of various groups of the population, in particular, using adaptation to hyperthermia [8, 13]. Hyperthermic Fitness Treatment (HFT) or passive whole-body hyperthermia is proved in many applied and clinical trials to be a helpful tool for enhancing thermal acclimation, physical tolerance and endurance, improving cardiovascular dysfunctions, normalizing metabolic status and body weight in patients with chronic non-infectious diseases and in aged healthy individuals [4, 14, 16]. Effects of sauna bathing, heat acclimation and hyperthermic treatments (adaptation to systemic, whole body hyperthermia, which leads to core temperature increase on 2,0-2,5°C) are accurately described in well-controlled medical studies, performed by experienced researchers imposing different protocols (from 1 session lasting 15-20 min, daily 1 week up to 2 sessions per day, 3 weeks) [14, 17, 18]. The general result of the most trials suggests adaptation to hyperthermia (sauna bathing sessions) is accompanied by a multi-faceted molecular, cellular, organic and systemic, organismic responses – by progressively increased resistance to thermal stressors, increased bronchial conductivity and pulmonary ventilation, sweating; stimulated activation of neuro-humoral and cardiovascular systems, boosted microcirculation and, as a consequence, providing more efficient transport and utilization of O<sub>2</sub> by body tissues, resulting in increase of exercise tolerance, physical activity, normalization of appetite, balancing thermogenesis and heat release [9, 17, 25, 30]. Mechanisms underlying the described clinical effects are partially connected with increased production of some neurotransmitters, hormones and peptides, among them – Brain derived neurotropic factor (BDNF), Human Growth Hormone(HGH), Heat Shock Proteins family as cell signaling pathways inducers etc. [11, 14, 15, 26]. In spite of difference in study design, protocols, and hyperthermic machines - devices, it is safe to make the conclusion that periodic individually adapted hyperthermic sessions are capable to induce haematological, neuro-humoral, cardio respiratory and antioxidant adaptation to provide pathogenetic treatment and rehabilitation of patients with chronic non-infectious diseases. Enhanced stress resistance and improved oxygen transfer/utilization are basic mechanisms whereby the

organism increases its resistance to any physical and environmental stressors and to variety of pathogenic factors.

### **Study hypothesis:**

HFT, delivered by “Cocoon” system as multiple repeated sessions, could lead to improving psychophysiological status, cardiovascular performance, and physical conditions, and key biomarkers in relatively healthy physically untrained volunteers.

### **Research organization and methods**

The randomized controlled study comprised 30 volunteers (males, average age  $20.2 \pm 2.1$  y.o.). The research protocol was formed in compliance with the provisions of “Bioethical rules of human research” and approved by the Bioethics Commission of the University. All respondents gave their written informed consent prior to the examination.

After preliminary examination, all participants were divided into two groups (block randomization 1:1 in blocks by 6 based on randomization list): Hyperthermia Fitness Treatment group (HFT, 15 people), who later underwent 24 procedures of passive hyperthermal adaptation, and Light Intermittent Exercise group (LIE, 15 people), who underwent 24 training sessions with elliptical gym apparatus in interval regime. The participants of the two groups did not differ by the key demographic characteristics (Table 1).

Table 1

#### **Key demographic characteristics of the research participants**

<b>Indicators</b>	<b>HFTgroup</b>	<b>LIEgroup</b>
Age, years	20.7 $\pm$ 2.3	20.0 $\pm$ 0.3
Body mass index, kg/m <sup>2</sup>	23.7 $\pm$ 3.1	22.6 $\pm$ 2.9
Smoking	9 (64.3%)	4 (36.4%)
Taking medications	14.3% (n=2)	9.1% (n=1)
SpO <sub>2</sub> , %	97.9 $\pm$ 1.05	98.1 $\pm$ 2.1
Heart rate at rest (HR), bpm	68.2 $\pm$ 10.7	70.0 $\pm$ 8.9
Systolic arterial pressure, mmHg	126.8 $\pm$ 13.4	125.1 $\pm$ 8.9
Diastolic arterial pressure, mmHg	76.5 $\pm$ 8.3	79.4 $\pm$ 6.7

Legend: the data are represented as mean  $\pm$ SD or n/N (%).

#### **Hyperthermic procedures and intermittent training**

The HFT participants underwent a course of passive hyperthermal adaptation using a capsule Alfa Basic (Sybaritic Inc., Minnesota, USA). The capsule is an ergonomic camera in which an athlete may take a lying position and undergo hyperthermia procedures (infrared heating), the head being outside the camera blown by cool air with a built-in ventilator.

Preliminarily, all HFT participants underwent a testing hyperthermia procedure (HP) in the capsule, with increasing of temperature from 40°C by 10°C each 10 minutes till the individual subjective tolerance threshold is achieved, then the body core temperature was measured. Further, the parameters of hypermetric adaptation procedures were selected individually by the results of the testing procedure. On average, the temperature in the capsule was established at 65–80°C, while the temperature of the subject's body core by the end of the procedure increased by 1.5–2.0°C. The recommended duration of one procedure was 40 minutes. In general, each HFT participant underwent 24 hyperthermia procedures in the following regime: the first period – 3 procedures a week every second day, total 12 procedures in 4 weeks; the second period – 2 procedures a week, 12 procedures in 6 weeks.

All subjects were recommended to attend the procedures in well hydrated state, not less than three hours after meals and caffeine intake, not to change the dietary pattern during the research period. As any influence would be obviously eliminated in case of attempting to organize placebo procedures in the thermal capsule, the LIE participants were invited to the laboratory at the same periods and with the same frequency as the HFT group.

The former underwent training on elliptical gym apparatus HouseFit N-300 (China) in interval regime: moderate loads (45–55% from the individual values of HR max) during 6–7 minutes were interchanged for rest periods (treadling with 25–30% load of HR max). Duration of each interval training (IT) session was 40 minutes, total 24 trainings in 10 weeks. Before and immediately after each HP/IT, the following measurements were made for each volunteer still within the capsule (sitting on the elliptical gym apparatus): HR, systolic and diastolic arterial pressure (SAP and DAP, automatic tonometer AND UA-767, AND, Japan), body core temperature (infrared thermometer AND DT-635, AND, Japan) as a mean of double measurements in both axillary regions. Besides, in the dynamics of each procedure we monitored the blood saturation with oxygen (SpO<sub>2</sub>) and HR with a pulseoxymeter MD300 (BCE Tech, China).

### **Estimating the parameters of exercise tolerance and cardio-respiratory endurance**

Initially, after 12 procedures of hyperthermia (interval trainings) and after a 10-week cycle of HP/IT (after 24 procedures) we estimated the parameters of the body

composition with a portable bio-impedance meter Tanita BC-601 (Tanita, Japan), calculating the muscle mass in kg and fat mass in % to the total body mass. In the same period, all participants underwent a cardiopulmonary exercise test (CPET) with a gas analyzer FitmateMED (COSMED, Italy) and a running machine Intertrack (Shiller, Switzerland) by BRUCE protocol (step load of increasing intensity up to refusal, duration of each step 3 minutes (initial speed 1.7 mph increasing to 2.5, 3.4, 4.2, 5.0 and 5.5 mph, initial angle of the running track 10° increased at each step by 2° (American College of Sports Medicine, 2006; Nieman et al., 2007)). All participants preliminarily underwent familiarization with load testing; the gas analyzer was calibrated before each testing. Prior to doing the load testing, we estimated the breathing function, registering the following indicators: forced vital capacity (FVC), forced expiratory volume in the first second (FEV1), peak expiratory flow (PEF), mean expiratory flow at the levels of large, middle, and small bronchi (MEF-75%, MEF-50%, and MEF-25%, respectively). In the test dynamics, the HR values were monitored continuously with the sensors of a breast strap Polar 610i (Finland), the signal of an optoelectronic sensor in the mask as transmitted to the gas analyzer. The values of all registered indicators were averaged for each 15-second interval. Borg scale was used to objectify the subjective self-reports on the load. On average, the test was completed in 14-15 minutes. When analyzing the dynamics of aerobic efficiency and cardio-respiratory endurance, the following indicators were taken into account: maximal heart rate (HR<sub>max</sub>), % of HR<sub>max</sub> from predicted individual values, blood pressure increase at each stage of load, at maximal load, and during restoration period, peak oxygen consumption (VO<sub>2peak</sub>), % VO<sub>2peak</sub> from predicted values (VO<sub>2peak</sub>, %), oxygen consumption at the level of anaerobic threshold (VO<sub>2AT</sub>), % of VO<sub>2AT</sub> from predicted values (VO<sub>2AT</sub>, %), respiratory frequency (Rf), peak pulmonary ventilation (VE), oxygen pulse (VO<sub>2peak</sub>/HR<sub>max</sub>), ventilatory equivalent of oxygen (VE/VO<sub>2peak</sub>). All testing was carried out in a laboratory premises at the temperature of 21–23°C.

### **Evaluation of Quality of Life**

We assessed QOL using the Medical Outcomes Study Short-Form 36-Item Health Survey (SF-36), which is a self-completed quantity of health-related QOL. This questionnaire comprises eight domains covering physical functioning, vitality, role-physical, social functioning, bodily pain, role-emotional, general health and mental health [29]. A high score indicates a better QOL characteristic. Furthermore, there are two summary scores which summarize two domains: first the Mental Component Summary and second the Physical Component Summary. SF-36 questionnaire translation into Russian and testing of the methodology was carried out by the Institute of Clinical and Pharmacological Research (St. Petersburg) (web resource access mode: <http://bono-esse.ru/blizzard/RPP/sf36.pdf>).

### **Measurement of Blood Markers**

Peripheral venous blood (10 ml) samples of the fasting (overnight fast) study subjects were with drawn by a qualified laboratory technician via a septic technique from the antecubital vein in the sitting position, using sterile needles and were collected into vacuum tubes between 8:00 and 9:00 am in order to take in account a possible circadian rhythm. To minimize the source of platelets, blood was allowed to clot (BD Vacutainer Plus SST) and serum was separated immediately (centrifugation at 3500 rpm at 4°C for 15 min after sampling), then harvested, aliquoted and stored at – 80°C until further analysis. Serum BDNF, HGH, HSPs (60, 70, 90) concentrations were determined in the laboratory «EFIS», authorized by the Regional department of Health (Moscow) for execution of clinical and biochemical/ hormonal blood analyses for the university's hospitals. *Serum levels of BDNF* measured using an enzyme-linked immunosorbent assay (ELISA) kit Human Free BDNF Quantikine ELISA, DBD00, P125979 (R&D Systems) according to the manufacturers instructions on the photometer Multiskan original 352 (Labsystems, Finland).

All samples and standards were measured in duplicate, and the means of duplicates were used for statistical analysis. All samples from a given participant were analysed in the same microliter plate to minimize run-to-run variability.

The sensitivity as reported in the ELISA literature was 7,8 pg/ml. *Serum level of Human Growth Hormone* was measured by radioimmunoassay technique (Skybio Ltd, Bedford, UK, assay kit IMMULITE® 2000 (*Growth Hormone*). Reference data were considered for males - up to 3 ng/ml; for females – up to 8 ng/ml. *Serum levels of HSPs* were measured using the high-sensitivity enzyme immunometric assay (EIA) kits: Manufacturer - Enzo Life Sciences Inc;

Photometer Multiskan original 352 (Labsystems, Finland), Serum HSPs concentrations were expressed in ng/ml. All analyses for HSPs were conducted in duplicate, and the samples were thawed only once in the analysis process.

### **Statistical analysis**

The data were analyzed with Statistica 11.0 software. The data are represented as a mean and standard deviation  $M \pm SD$ . Checking for normal distribution was carried out with Kolmogorov-Smirnov test; to estimate the significance of intra- and inter-group differences in dynamics, we used one-sample t-test, Wilcoxon test (for intra-group comparisons) and Mann-Whitney test (for inter-group comparisons). The differences were considered significant at  $p < 0.05$

## **Results**

### *Physiological responses of the study participants to HP and IT*

A typical adaptive physiological response of HFT group participants to systemic passive hyperthermia treatments was an increase in core body temperature by an average of 2°C, a quite tremendous decrease in the values of SBP and DBP by 10-15 mm Hg, an increase in HR by 35-40 bpm.

The averaged reactions of the participants examined to receive passive heating procedures (average data for all 24 procedures) are presented in Table 2. At the same time, interindividual variations were noted in the response of individual subjects to hyperthermic training: the increase in core temperature by the end of the hyperthermic session ranged from + 1.1 °C up to + 6.1 °C; HR values increased from + 8 bpm to + 92 bpm, SBP values ranged from +14 mm Hg to -41 mm Hg, DBP values - from +12 mm Hg to -42 mm Hg. In contrast to the HFT group in the LIE group, when performing IT at ellipsoid machine, the core temperature and the blood pressure values did not change significantly, only moderate tachycardia was observed - an increase in HR values by an average of 30 bpm. At the same time, individual reactions to interval exercise training were also very variable - changes in body core temperature varied from -1.1 °C to + 2.1 °C, fluctuations in SBP values were from +2 mm Hg to +52 mm Hg, and in DBP values from -32 mm Hg to +36 mm Hg, tachycardia level varied from +42 bpm to +82 bpm.

### **Blood markers of hyperthermic acclimation**

Statistical analysis showed no significant differences between groups in values of BDNF, HGH, HSPs at the baseline (Table 3). The variation coefficients for repeated analyses for BDNF, HGH and HSPs concentrations in CTRL group were 4% (BDNF), 3,5% (HGH), 2%, (HSP60), 4% (HSP70) and 7% (HSP90) respectively, reflecting quite stable levels of such markers' values without any significant stressors. After 12 HPs the HSP60 values significantly increased in the HFT group, remaining significantly higher than at pretreatment test after the full course of procedures.

In HFT group significant increase in BDNF values was observed after 12 and 24 sessions, however this data did not differ significantly from post-intervention data in the LIE group (Table 5). When analyzing pre-post shifts in biomarkers' values in HFT or LIE groups, it was also found that meaningful changes occurred only in the dynamics of BDNF - a significant increase on 13,5±7,1% after 24 procedures of hyperthermia while in LIE group the shift in BDNF after 24 trainings was negative -6,3±15,6%. Shifts in the values of other biomarkers showed no reliable dynamics. It is also necessary to

note the significant interindividual variability of the blood indicators - HSPs, HGH, BDNF at pre-treatment period as well, as in dynamics of both HPs or Its (with opposite - increasing and decreasing values of individual indicators).

### **Psychometric correlates of passive hyperthermic acclimation**

The data of self-reporting scales of the quality of life (QOL) in study dynamics are presented in table 4.

Table 2

#### **Average Dynamics in Physiological parameters before and after Hyperthermia Fitness Treatments (HFT) and Light Intermittent Exercising (LIE)**

Group	Study group (Hyperthermia Fitness Treatment, HFT), n=14			Control Group (Light intermittent exercising, LIE), n=11		
	Before	After	Delta	Before	After	Delta
Parameters:						
Bodycoretemperature, °C	36,5±0,4	38,1±0,8 *(p=0,002)	+1,7±0,4	36,4±0,1	36,3±0,4	-0,08±0,2 **p=0,005
Systolic Blood Pressure, mm Hg	120,9±17,8	117,2±13,7	-11,7±5,9	122,7±9,7	127,2±8,2	5,6±4,8
Diastolic Blood Pressure, mm Hg	73,5±11,3	55,1±8,3 *(p=0,003)	-15,8±6,0	70,0±5,7	67,9±7,5	2,0±5,1* *p=0,02
HeartRate, bpm	83,9±7,9	125,9±16,2 *(p=0,003)	+42±15,1	83,2±8,6	113,9±11,2	+ 30,6±14,0
SpO <sub>2</sub> , %	97,4±1,2	95,8±0,9 *(p=0,02)	- 1,5±1,8	96,9±0,3	96,2±0,5	-0,6±0,4

Average data, summarizing the results of each participant in 24 sessions of HFT or in 24 sessions of LIE. \* -difference significance to the data before HFT session. \*\* -difference significance in delta “before - after HFT” to delta “before - after LIE” session.

The moderate level of the State anxiety, average or above average points of self-assessment of general health in QOL, its physical and mental components, lack of pronounced sleep disorders were typical for almost all examined subjects in HFT and LIE groups. Despite the randomness of the distribution by groups, the participants of 2 groups differed significantly in pre-intervention values of subjectively assessed QOL several domains. In LIE group, the values of self-assessments for the general health (GH), emotional status (RE), bodily pain (BP), vitality (VT), mental health (MH) domains were significantly higher than in HFT group, reflecting better subjectively estimated rank in QOL. But in dynamics of IT sessions - neither after 12 nor after 24 trainings parameters of all QOL



domains in LIE group did not change. In HFT group a significant increase in the values of quality of life' indicators by GH, PF, RP, RE, SF, VT, MH domains was noted already after 12 hyperthermic procedures. After 24 procedures, there was a further increase in almost all the domains of QOL, although they did not exceed the values of the corresponding indicators in LIE group.

### **Cross-effects of adaptation to systemic repeated hyperthermia**

As cross-effects of adaptation to repeated exposures of passive systemic hyperthermia we assessed levels of aerobic performance and exercise tolerance in CPET, performed in thermo-neutral conditions (not in the heat), resting respiratory, cardiovascular parameters were no significant differences in cardio-respiratory fitness indices between participants of 2 tested groups, as well as in the dynamics of interval exercise interventions in the LIE group (Table 5). At baseline all the participants of HFT and LIE groups were healthy and physically fitted (average level of aerobic performance -  $\text{VO}_2\text{max}/\text{BM}$  was  $40,5 \pm 4,1$  ml/min/kg, which can be considered as normal for young men, non-athlets). After 12 sessions of HP there was significant increase in parameters of exercise time to fatigue, oxygen consumption at the level of anaerobic threshold  $\text{VO}_2\text{AT}$ - by  $16.3 \pm 12.0\%$  with a significant hyperventilatory response (increase in VE values on  $15\% \pm 21.7\%$ , respiratory frequency  $R_f$  max- by  $15.9 \pm 21.7\%$ , and the values of the equivalent  $\text{VE}/\text{VO}_2$  peak exceeded those of the LIE group). The degree of QOL domains increment (pre-post 24 sessions) was significantly higher in HFT group, except for the scale of physical functioning (PF).  $\text{VO}_2\text{max}$  in HFT group increased on  $9,9\% \pm 17,8$  and became significantly higher than in LIE group. At post-treatment in HFT group there were further significant increase in exercise time to fatigue and in the values of aerobic performance -  $\text{VO}_2\text{max}$ ,  $\text{VO}_2\text{max}/\text{BM}$  (and  $\text{VO}_2\text{max}$  in% to individual predicted values) - by  $12.5 \pm 8,3\%$  and  $8.1 \pm 9.0\%$ , respectively, a further increase in  $\text{VO}_2\text{AT}$ , as well as an increase in the values of the  $\text{O}_2$  pulse ( $\text{VO}_2\text{max}/\text{HRmax}$ ), reflecting improved cardiac efficiency under submaximal exercise. At the same time, a significantly higher ventilatory "response" (VE) to the load was maintained, and no changes in the chronotropic response to exercise (no significant changes in HR max) were noted. This fact reflects the increase in the power of biosubstrates' aerobic oxidation mechanisms while doing graded exercise test in HFT group members who, during the time of passive hyperthermic procedures, did not engage in additional sports or amateur exercise training.

Table 3

**Blood biomarkers data before and after 12 and 24 sessions of the interventions**

Parameters	Group	Before	After 12 sessions	After 24 sessions	DeltaPre-Post 12 sessions	DeltaPre-Post 24 sessions
HSP 60, ng/ml	HFT	2,9±4	4,8±4,9 *(p=0,03)	4,3±5,4 **(p=0,05)	1,9±3,7 (156±370%)	1,4±3,1 (67±158%)
	LIE	1,9±2,3	2,2±2,1	1,3±0,7	0,3±3,1 (103±218%)	-0,5±2,5 (28±69%)
HSP 70, ng/ml	HFT	0,2±0,2	0,2±0,2	0,3±0,4	0,03±0,1 (185±547%)	0,09±0,2 (53±89%)
	LIE	0,1±0,2	0,2±0,2	0,1±0,2	0,01±0,07 (57±197%)	-0,01±0,05 (12±150%)
HSP 90, ng/ml	HFT	15,5±3,6	14,3±4	14,3±4,7	-1,2±3,5 (-5,7±23,9%)	-1,2±4,7 (-5±30,2%)
	LIE	14,8±4,1	14,4±2,4	14,9±2,5	-0,4±2,8 (0,9±19%)	0,1±3,1 (4,2±20,1%)
BDNF, pg/ml	HFT	26710±5437	28238±5183 *(p=0,04)	30170±5268 **(p=0,005)	1528±1946 (6,2±6,7%)	3460±1832 (13,5±7,1%)
	LIE	26114±3841	25198±3729	24104±2876	-916±6489 (-0,3±28,6%)	-2010±3829 (-6,3±15,6%) #(p=0,01)
HGH, ng/ml	HFT	0,9±1,9	1,7±3,1	2,1±3,3	0,8±3,9 (1744±3270%)	1,1±3,2 (2494±6071%)
	LIE	1,4±3,2	0,9±2,6	1,0±1,9	-0,5±0,9 (50±191%)	-0,4±3,9 (575±1477%)

Difference significance: \* - after 12 sessions to the data before HFT sessions; \*\* - after 24 sessions to the data before HFT sessions; # - between LIE and HFT groups at the same stage of assessment.

This fact can be explained by initial high levels of PF domain in both groups and by involving the LIE group participants in regular exercising and HFT group – in passive heating in equal frequency. It is also important to note a significant increase in the values of the integral domains of the QOL - the Mental component (MH) and the Physical component (PH) both after 12 and after 24 HPs. At the end of the course of heating procedures, the increase in these indicators in HFT group significantly exceeded their slight changes in LIE group (Table 4).

Table 4

**Parameters of Life Quality Self-assessment in MOS SF-36 scales**

Parameter	Group	Baseline	After 12 sessions	After 24 sessions	DeltaPre-Post 12 sessions	DeltaPre-Post 24 sessions
GenelalHealth (GH)	HFT	65,4±10,9	76,8±11,2 *(p=0,008)	88,8±9,7 **(p=0,005)	11,4±9,9 (19,1±19,3%)	23,4±11,8 (38,7±24,8%)
	LIE	85,7±16,1 #(p=0,01)	91,8±12,6	85,4±12,5	6,1±19,5 (12,4±37,3%)	-0,3±20,8 (5±37,6%) #(p=0,03)
PhysicalFunctioning (PF)	HFT	92,5±9,8	96±5,7 *(p=0,005)	98±3,5 **(p=0,03)	3,5±4,7 (4,4±6,6%)	5,5±6,4 (6,8±8,9%)
	LIE	99,5±1,6	99±2,1	100±0	-0,5±1,6 (-0,5±1,6%)	0,5±1,6 (0,5±1,7%)
RolePhysical (RP)	HFT	60±26,9	82,5±20,6 *(p=0,03)	97,5±7,9 **(p=0,01)	22,5±21,9 (58,3±66,3%)	37,5±27 (101,7±111,2%)
	LIE	87,5±21,2 #(p=0,04)	85±26,9	85±24,2	-2,5±7,9 (-5±15,8%) #(p=0,03)	-2,5±7,9 (-3,3±10,5%) #(p=0,01)
RoleEmotional (RE)	HFT	47,2±23,1	67±22 *(p=0,03)	90,1±15,9 **(p=0,008)	19,8±17 (53,5±48,3%)	42,9±22,3 (116,6±72,9%)
	LIE	93,4±13,9 #(p=0,01)	93,4±13,9	93,4±13,9	0±22 (3,3±27,7%) #(p=0,04)	0±0 (0±0%) #(p=0,008)
SocialFunctioning (SF)	HFT	46,4±10,3	52,7±8 *(p=0,04)	58,2±10	6,3±6,7 (16,7±19%)	11,8±16 (33,4±44,6%)
	LIE	50±0	50,1±5,9	47,7±7,8	0,1±5,9 (0,2±11,8%)	-2,3±7,8 (-4,6±15,6%) #(p=0,05)
BodilyPain (BP)	HFT	69,4±24	88,4±13,7 *(p=0,008)	95,8±9,2 **(p=0,008)	19±12,3 (43,2±55,3%)	26,4±19,9 (50,8±76,1%)
	LIE	92±10,8 #(p=0,04)	90,2±14,1	90,8±15,1	-1,8±10,4 (-1,8±12%) #(p=0,008)	-1,2±9,2 (-1,5±11%) #(p=0,008)
Vitality (VT)	HFT	57,5±15,5	69±13,9 *(p=0,005)	79±15,1 **(p=0,005)	11,5±4,7 (22,8±14,8%)	21,5±12 (42,7±30,1%)
	LIE	76,5±16 #(p=0,02)	71,5±18,3	71±20	-5±13,3 (-5,8±17,5%) #(p=0,008)	-5,5±14,8 (-6,9±18,7%) #(p=0,007)
MentalHealth (MH)	HFT	66,8±15	72,4±13,7 *(p=0,04)	82,4±14,1 **(p=0,01)	5,6±9,3 (10,4±20%)	15,6±11,1 (26,2±22%)
	LIE	84,4±8,1 #(p=0,02)	82,4±12,1	80,1±10,7	-2±12,7 (-1,9±14,1%)	-4,3±12,6 (-4,5±14,8%) #(p=0,008)
Physicalhealth (PH)	HFT	50,7±5,6	55,9±3,5 *(p=0,007)	57,9±1,4 **(p=0,005)	5,3±3,3 (11±7,2%)	7,2±5,4 (15,5±12,6%)
	LIE	53,6±8,2	56,1±4,6	55,7±3,8	2,5±8,4 (7,7±24,8%)	2,1±7,5 (6,7±22,1%) ##(p=0,04)

Neither the values of body mass, nor BMI in the comparison groups did not differ significantly at the baseline and did not change at post-interventional testing. Despite passing sessions of quite intensive heating by the participants of HFT group and interval exercising by moderate intensities in LIE group their body composition parameters (percentage of muscle and fat mass) also did not change. When analyzing the indices of pulmonary functions and external respiration, significant shifts in the parameter values were found only in the HFT group – after 12 passive hyperthermic procedures there were significant increment in PEF and MEF75%, MEF50%, and after a full course of heating procedures - also in FEV1, MEF75%, MEF50%, MEF25%. In average extend of 12–22% (Table 11). It should be noted that initially all study participants were healthy and had no obstructive, non-restrictive lung disorders, and the post-interventional increase in bronchial conductivity from large to small bronchi is an important positive effect of HFT.

### **Discussion**

To our knowledge and to-date our study is the first randomized controlled study to compare directly physiological, biomolecular and psychological effects of systemic repeated passive hyperthermia and regular light intermittent exercises in relatively healthy young men. Based on the position of direct and cross-adaptation effects, formed by repeated exposures of any stress factor (extreme or sub-extreme environmental factors that initiate a systemic non-specific stress response), we tested the hypothesis of adaptation formation to hyperthermia itself (direct effects), but also parallel increase in resistance to physical exertion, improvement of psychological and emotional status (cross-effects) as a result of multiple exposures of the systemic (onto the whole body, but with head-out of heating) individually tolerable hyperthermia. It is proved that repeated passive hyperthermic treatments are efficient to evoke stable beneficial effects of adaptation to heat in stimulation of BDNF and improvements in psychological status of healthy young men. Course of 24 repeated systemic passive hyperthermic procedures in 10 weeks leads to a significant increase in plasma BDNF concentrations (by an average of 9-13%) and serum HSP-60 (by an average of 50-65%), which is accompanied by a significant increase in self-assessments of quality of life in domains of “general health”, “physical functioning”, “vitality”, “mental health”, “role-emotional”, decrease in subjective assessments of state and trait anxiety levels. In a parallel examination of the LIE group persons, who passed successively the same number of interval exercise training sessions of mild-to-moderate intensity, there were no significant changes in either one of the blood markers or in the parameters of psychometric scales and self-reports. There is evidence that adaptation to heat stresses is accompanied by stimulation of cytoprotection molecules (including HSPs) synthesis, which is based on epigenetic mechanisms [8, 13].

Table5

**Parameters of cardio-respiratory fitness in the study dynamics**

Parameters	Group	Before	After 12 sessions	After 24 sessions	DeltaPre-Post 12 sessions	DeltaPre-Post 24 sessions
VO <sub>2</sub> max, ml	HFT	2961,7±473,9	3216,7±483,1 <i>*(p=0,04)</i>	3359,5±376,7 <i>***(p=0,01)</i>	255±444,9 (9,9±17,8%)	397,8±448 (15,4±18,6%)
	LIE	3031±540,8	2859,1±489,5	2845,3±594,9	-190,8±298,7 (-5,5±9,5%) <i>##(p=0,02)</i>	-208,2±381,4 (-6,6±13,2%) <i>##(p=0,01)</i>
VO <sub>2</sub> max, %	HFT	91,8±10,3	96,8±12,6 <i>*(p=0,05)</i>	100±7,9 <i>***(p=0,01)</i>	5±6,9 (5,5±7,4%)	8,2±6,3 (9,6±7,8%)
	LIE	97,6±13,1	96±7,7	90±11,9	-1,6±7,4 (-0,9±7,2%)	-7,6±13,5 (-6,9±13,1%) <i>##(p=0,01)</i>
VO <sub>2</sub> max/BM ml/Kg/min	HFT	38,7±4,3	40,9±5,3 <i>(p=0,05)</i>	42,2±3,3 <i>***(p=0,01)</i>	2,1±2,9 (5,5±7,4%)	3,5±2,7 (9,6±7,8%)
	LIE	41±5,3	40,4±3,1	38,1±4,8	-0,7±3,1 (-0,9±7,2%)	-3,2±5,7 (-6,9±13,1%) <i>##(p=0,02)</i>
VE, l/min	HFT	98,6±18	114,1±21,6 <i>*(p=0,03)</i>	121,7±14 <i>***(p=0,02)</i>	15,5±19,8 (17,4±23,1%)	23,2±24 (27,8±30,1%)
	LIE	100,5±26,5	93,6±26	98,7±31,2	-6,6±14 (-6,1±13,9%) <i>##(p=0,02)</i>	-0,9±32,1 (1,8±35,4%)
Rfmax, cpm	HFT	38±8,3	43,7±5,9 <i>*(p=0,02)</i>	43,7±10,9	5,7±5,6 (19,1±25,3%)	5,7±11,6 (20,1±37,8%)
	LIE	40,9±9,6	38,5±9,5	40,7±8,5	-2,5±6,7 (-3,8±26,2%) <i>##(p=0,02)</i>	0,2±14,2 (10,6±54,2%)
HR max, bpm	HFT	178,7±11,3	183,1±11	180±14,2	4,4±9,2 (2,6±5,5%)	1,3±18,7 (1,1±10,8%)
	LIE	176,5±16,4	177,2±11,9	171±17	0,7±16,4 (1,1±11,3%)	-6,2±22,4 (-2,7±14,2%)
HRmax, %	HFT	89,3±5	91,5±5,5	90±7,4	2,2±4,7 (2,6±5,5%)	0,7±9,4 (1,1±10,8%)
	LIE	87,3±8,5	87,6±6,3	84,2±8,5	0,4±8,1 (1,1±11,3%)	-3,1±11,1 (-2,7±14,2%)
VO <sub>2</sub> AT, ml/Kg/min	HFT	18,6±2,5	22±3 <i>*(p=0,01)</i>	22,6±2,2 <i>***(p=0,005)</i>	3,4±2,3 (18,5±11,9%)	3,9±1,9 (21,9±11,8%)
	LIE	22,1±3	21,3±4,2	20,6±3,5	-0,5±6,1 (0,5±29,3%)	-1,1±5,1 (-3±21,3%) <i>##(p=0,04)</i>
VO <sub>2</sub> AT, %	HFT	48,4±6,1	54,3±8, <i>*(p=0,01)</i>	53,6±5, <i>***(p=0,01)</i>	6±4,4 (12,4±9,2%)	5,2±4,2 (11,4±9,1%)
	LIE	53,8±8,6	53,6±13,4	55,5±11	-0,2±16,6 (2,4±33,9%)	1,7±11,4 (4,6±21,9%)
VO <sub>2</sub> max/HR	HFT	16,5±2,3	17,6±2,4	18,8±2,7 <i>***(p=0,03)</i>	1±2,8 (7,5±18,9%)	2,2±2,6 (14,6±17,8%) <i>##(p=0,01)</i>

	LIE	17,4±4,8	16±2,6	16,5±3	-1,5±2,7 (-5,8± 12,4%)	-1±2,6 (-3,3±12,1%)
EQO2(VE/VO 2)	HFT	25,4±3,7	28±4,9	28,9±3,3	2,6±5,5 (12,2± 25,8%)	3,5±5,5 (16,4±24,8%)
	LIE	24±5,2	22,8±6	25,4±6,1	-1,2±2,8 (-5,5± 11,8%)	1,4±6,7 (8,6±33,1%)
Exercisetimet ofatigue, s	HFT	925,5±202,2	1100±129,1 *(p=0,04)	1100,8± 103,1	174,5±207,1 (24,4± 31,3%)	175,3±231,1 (25,7±37,3%)
	LIE	1035,5±69,4	1036±26,6	991±121,5	0,5±73,8 (0,5±7,7%) #(p=0,01)	-44,5±152,3 (-3,7±14,9%) ##(p=0,04)

Under stress, HSPs can be secreted by cells and perform an immunomodulatory function, the mechanisms of which are unique to different proteins [2, 21]. The action can be pro- or anti-inflammatory, which depends, for example, on their concentration.

Therefore, available information on the role of extracellular HSPs is controversial [22]. For example, according to the results of experiments [21], extracellular HSP-60 stimulates proliferation and regenerative processes, and activates microglia and serves as a signal for oligodendrocyte apoptosis [10]. The authors believe that the degree HSPs induction is enhanced and prolonged by additional factors, such as dehydration and plasma hyperosmolarity, while under physiological stress, HSP-72 level quickly returns to its original level. We determined the extracellular level of HSPs 2 days after the end of heating procedures and registered an increase only of HSP-60 in experimental group, but not in persons who have been trained by intermittent exercise. Probably, the obtained results indicate that the method of adaptation to passive repeated hyperthermia applied by us is a stimulus, firstly sufficient to activate the synthesis and secretion of HSPs, secondly not excessive, because the level of HSP-70 and HSP-90 remained unchanged. In our work, for the first time, an increase in the serum BDNF was observed during long-term adaptation to passive repetitive hyperthermic treatments. In contrary, exercise trainings of low-to-moderate intensity, applied by us in LIE group, had no effect on serum BDNF, measured 2 days at follow-up the last training session. This is consistent with the literature data, according to which the BDNF stimulation occurs under significant stressors, for example, intense exercise, exceeding the anaerobic threshold [6, 12, 31], which is accompanied by body core temperature increment on 1.5-2.5°C. And the same level of hyperthermia was achieved in our study in each of 24 hyperthermic sessions in almost all volunteers. The exercise-induced increase BDNF was reported to be related to a corresponding increment in body core temperature [3, 24]. In that study, serum BDNF levels were higher during exercise conducted at 30°C

room temperature, compared to that in a room set at 18°C. The results suggested that the rise in core temperature augmented the increase in serum BDNF level during exercise.

Moreover, the study of D.Kojima [15] reported head-out immersion of young volunteers in hot water for 20 min was accompanied by increase of core temperature and serum BDNF (in physical rest conditions), suggesting that a high body core temperature acts independent of exercise to increase serum BDNF levels. The mechanisms underlying the stimulation of BDNF synthesis by thermal stressors or by exercising have been little studied. Participation of intracellular calcium ions, active metabolites of oxygen and lactate is supposed [12]. It is known that the sources of BDNF, in addition to the brain, can be blood cells, vascular endothelium, and other tissues, for example, skeletal muscles, where BDNF participates to upregulate regenerative processes [3, 23].

### **Cross-effects of adaptation to passive hyperthermia: improved aerobic performance and exercise tolerance, pulmonary functions**

It was shown adaptation to the course of passive hyperthermia leads to a moderate increase in aerobic performance and cardio-respiratory endurance in healthy volunteers – non-athletes, tested while they perform an incremental treadmill test to fatigue in thermo-neutral conditions. Since the LIE group, whose participants were of the same level of initial cardiorespiratory fitness and visited the laboratory in a similar mode to perform interval exercise training of moderate intensity, did not reveal significant changes in the analyzed indicators, we believe that the effect of hyperthermic stress is the leading factor in the identified adaptive shifts in aerobic performance. It is believed that to start thermoregulatory adaptive processes that are important in adapting to metabolic stressors (exercise loads by different intensities), it is necessary to increase body core temperature by 1.5-2.5°C [27, 28], which was a key factor in the dosing of hyperthermic procedures in our study. The noted “ergogenic” effects of adaptation to passive hyperthermia can be partially explained by a series of morpho-functional changes, triggered by repetitive procedures for increasing body core temperature and positive for better adaptation to metabolic stress, induced by exercise test in normothermic conditions: improved cardiac performance due to a moderate decrease in blood pressure and afterload, an increase in the dermal and muscular blood flow, blood plasma volume, a decrease in the submaximal values of the heart rate, the stimulation of oxygen extraction by muscles due to reducing the affinity of hemoglobin to oxygen, as well as stimulating capillarization, increasing the power of antioxidant mechanisms and stimulating the production of nitrogen monoxide as a modulator of oxygen-dependent

processes occurring in the body (blood oxygen transport function prooxidant-antioxidant balance etc.) [5, 19, 20, 30].

Important in the understanding of heat triggered adaptive changes seems to be identified in the work, a significant increase in exercise pulmonary ventilation, as well as indices of bronchial conductivity at rest, which can be considered as a mechanism of adaptation to recurrent passive hyperthermia, rather than a decrease in exercise pulmonary efficiency, and is consistent with data of A.E. Beaudin et al. [1].

The authors of this study showed that increased exercise pulmonary ventilation (more metabolic requests) after a course of 10 passive hyperthermic procedures is due to a decrease in the temperature threshold (lower gradient of increasing body core temperature) of the ventilatory response, similar to reducing the sweating threshold, which is a component of the thermolytic efferent "response" to repeated episodes of hyperthermia, triggered from the preoptic nuclei of the anterior hypothalamus, but not the consequence of increased sensitivity of the respiratory center to CO<sub>2</sub> (that is considered to be a sign of exercise training) [1, 28]. The changes in bronchial conductivity, revealed in the study, cannot be associated with stimulation of the thermoreceptors of the respiratory tract, since in our study, the head of the HFT participants was out of the Cocoon chamber during the hyperthermic procedures and was not exposed to heat, and they breathed by air at a neutral temperature. Potential factors for improving pulmonary ventilation and bronchial conductivity at rest after a course of passive hyperthermia may be the normalization in dynamics of nitrogen monoxide production in the pulmonary parenchyma, which affects pulmonary blood flow and ventilation, as well as certain training of the respiratory muscles during hyperthermic influences (quite tremendous hyperventilatory pattern, induced by each heating treatment) [14, 24, 30], however, these assumptions require additional verification.

### **Limitations and Outlook**

This study has several limitations. First, the sample size was small (11-14 participants in each group of comparison). Second, the blood samples were only analyzed at baseline and after 12 (4 weeks) and 24 (another 6 weeks) of interventional sessions (head-out systemic hyperthermia or intermittent exercise training at low intensities in thermoneutral conditions), without assessment of acute, immediate pre-postheating changes in one hyperthermia treatment (or intermittent exercise session). The other limitation is the absence of the placebo group, which would include participants, who will spend proper time periods being laid in Cocoon thermo-capsules under normothermic conditions, without proper thermal exposure.

Significant inter-individual variations in adaptive responses of recruited volunteers to passive hyperthermia suggest the presence of individuals who are resistant



and/or sensitive to heating, which requires the development of criteria / indicators for determining and predicting the effects of passive hyperthermic adaptation. Additional assessments should examine the effects of chronic repeated hyperthermic exposures on the interplay between resting levels of BDNF, HSPs, cardiovascular fitness and cognitive functions in human subjects. Further, investigations into the response of BDNF and HGH to an acute single hyperthermic treatment before and after the course of repeated systemic hyperthermic exposures in other groups of aged population might bring additional data on the relationships between circulating BDNF levels, other hormones, cognitive and psychological state and cardiovascular fitness and their interactions. An intensive assessment (psychology, cognitive tests, additional blood markers, oxydative stress indicators) would be useful to analyze the physiological adaptations to a single session and to repeated treatments by systemic passive hyperthermia in the light to stimulate neuroplasticity and cognitive capacities.

### **Conclusion**

The present study is to our knowledge the first to demonstrate that repeated sessions of systemic passive hyperthermia (whole-body infrared heating with head-out of Cocoon capsule) resulted in significant increase in serum BDNF in young healthy men. Such BDNF increase was associated with marked improvements in quality of life characteristics. Moreover, in contrary to several research works showing no effects of heat acclimation to aerobic performance in humans, tested in normothermic conditions, our study demonstrated significant increment of aerobic performance and exercise tolerance in healthy men, repeatedly tested in conditions of comfortable environmental temperature after 12 and then after 24 sessions of passive hyperthermia. Light-to-mild intermittent exercising in the same frequency as passive heating did not affect neither BDNF levels, no parameters of exercise tolerance and quality of life. The results suggest hyperthermically induced elevation of body core temperature to 38,0 – 38,5°C is particular trigger stimulus to induce a cascade of molecular and cellular adaptive processes evolving other mechanisms than exercising. We consider our results quite promising to offer passive hyperthermia as non-pharmaceutical adjuvant to multimodal rehabilitation programs for patients with age-related declines, mild dementia or even at initial stages of neurodegenerative diseases, for boosting cardiorespiratory fitness, improvement of neurological health, cognitive functions and quality of life in relatively healthy population.

### **References**

1. Beaudin A.E., Clegg M.E., Walsh M.L., White M.D. Adaptation of exercise ventilation during an actively-induced hyperthermia following passive heat

- acclimation. *Am. J. Physiol. Regul. Integr. Comp. Physiol.* 2009; 605.
2. Brigadski T., Leßmann V. BDNF: a regulator of learning and memory processes with clinical potential. *E -Neuroforum* 2014; 5: 1–11.
  3. Bekinschtein P., Oomen C., et. al. Effects of environmental enrichment and voluntary exercise on neurogenesis, learning and memory, and opattern separation: BDNF as a critical variable. *Seminars in Cell & Developmental Biology.* 2011; 22: 536-542.
  4. Biro S, Masuda A, Kihara T, Tei C. Clinical implications of thermal therapy in lifestyle-related diseases. *ExpBiol Med (Maywood).* 2003; 228(10):1245-9.
  5. Cotman C., Berchtold N., Christie L. Exercise builds brain health: key roles of growth factor cascades and inflammation. *Trends in Neurosciences.*2007; 30(9):464-472.
  6. Ferris L.T., Willaiams J. S., Shen C-L. The Effect of Acute Exercise on Serum Brain-Derived Neurotrophic Factor Levels and Cognitive Function. *Med. Sci. Sports Exerc.* 2007. 39(4): 728–734.
  7. Glazachev O.S. Technologies for Psychophysiological Functions’ Correction and Health Reserves’Potentiaion: Implementation of Adaptive Medicine Principles. *Herald of the International Academy of Sciences. Russian Section.* 2013; 1: 45-54.
  8. Gibson O.R., Taylor L., Watt P.W., Maxwell N.S. Cross-Adaptation: Heat and Cold Adaptation to Improve Physiological and Cellular Responses to Hypoxia //Sports medicine (Auckland, NZ.). 2017; 47: 1751.
  9. Gryka D., Pilch W., Szarek M., Szygula Z., Tota Ł.The effect of sauna bathing on lipid profile in young, physically active, male subjects. *Int J Occup Med Environ Health.*2014; 27(4):608-18.
  - 10.Iguchi M., Littmann A., Chang S., Wester L., Knipper J., Shields R. Heat stress and cardiovascular, hormonal, and heat shock proteins in humans. *Journal of Athletic Training.* 2012; 47(2): 184–190.
  - 11.Iwase S., Kawahara Y., Nishimura N., Sugenoja J. Effect of micro mist sauna bathing on thermoregulatory and circulatory functions and thermal sensation in humans. *Int J Biometeorol.*2016; 60(5): 699-709.
  - 12.Jiménez-Maldonado A., Rentería I., García-Suárez P.C., Moncada-Jiménez J. and Freire-Royes L.F. The Impact of High-Intensity Interval Training on Brain Derived Neurotrophic Factor in Brain: A Mini-Review. *Front. Neurosci.* 2018; 12:839.
  - 13.Horowitz M. Epigenetics and cytoprotection with heat acclimation. *J. Appl. Physiol.* 2016. 120: 702–710.
  - 14.*Hussain J., Cohen M.* Clinical Effects of Regular Dry Sauna Bathing: A Systematic Review. *Evidence-Based Complementary and Alternative Medicine.* 2018:1857(4): 13-30.
  - 15.Kojima D., Nakamura T., Banno M., Umemoto Y., Kinoshita T., Ishida Y., Tajima F. Head-out immersion in hot water increases serum BDNF in healthy males. *International Journal of Hyperthermia.* 2018; 34(6): 834-839.
  16. Laukkanen T., Khan H., Zaccardi F.,Laukkanen J.Association Between Sauna Bathing and Fatal Cardiovascular and All-Cause Mortality Events. *JAMA Intern Med.* 2015; 175(4): 542-48.

- 17.Laukkanen T., Kunutsor S., Kauhanen J., Laukkanen J. Sauna bathing is inversely associated with dementia and Alzheimer’s disease in middle-aged Finnish men. *Age and Ageing*. 2016; 0: 1-5.
- 18.LeeE., LaukkanenT., KunutsorS., KhanH., WilleitP., ZaccardiF., LaukkanenJ. Sauna exposure leads to improved arterial compliance. Findings from a non-randomised experimental study. *Eur. J. Prev. Cardiol*.2018; 25 (2):130-138.
- 19.Lorenzo S., Halliwill J., Sawka M. Heat acclimation improves exercise performance. *Journal of Applied Physiology*.2010; 109(4): 1140-1147.
- 20.Minson C.T., Cotter J.D. CrossTalk proposal: Heat acclimatization does improve performance in a cool condition. *J. Physiol*. 2016; 594: 241-243.
- 21.Pei W., Tanaka K., Huang S.C., et al. Extracellular HSP60 triggers tissue regeneration and wound healing by regulating inflammation and cell proliferation. *NPJ.Regen. Med*. 2016; 1: 16013-17.
- 22.Pereira E.S., Krause N.W., Calefi A.S., Georgetti M., Guerreiro L., Gama E.F. Significant Acute Response of Brain-Derived Neurotrophic Factor Following a Session of Extreme Conditioning Program Is Correlated With Volume of Specific Exercise Training in Trained Men. *Front Physiol*. 2018; 3(9):823.
- 23.Phillips C., Akif Baktir M., Das D., Lin B., &Salehi A.The Link Between Physical Activity and Cognitive Dysfunction in Alzheimer Disease. *Physical Therapy*.2015; 95(7):1046-1060.
- 24.Rasmussen P., Brassard P., Adser H., Pedersen M. V., Leick L., Hart E., et al.Evidence for a release of brain-derived neurotrophic factor from the brain during exercise. *Exp.Physiol*. 2009; 94:1062–1069.
- 25.Redberg R. Health benefits of sauna bathing. *JAMA Int. Med*. 2015; 175(4): 548.
- 26.Schmid J. Some like it hot: Cardiovascular health benefits of Finnish sauna. *European Journal of Preventive Cardiology*. 2018; 25(2):127–129.
- 27.Selsby J.T. Intermittent hyperthermia enhances skeletal muscle regrowth and attenuate oxidative damage following, reloading. *J.Appl Physiol*. 2007; 102: 1702-1707.
- 28.Vigas M., Celco J., Koska J. Role of body temperature in exercise induced growth hormone and prolactin release in non-trained and physically fit subjects. *Endocrine regulations*. 2000;34: 175-180.
- 29.Ware J.E., Sherbourne C.D. The MOS 36-item short form health survey (SF-36): conceptual framework and item selection. *Med Care*. 1992; 30: 473-483.
- 30.Zinchuk V., Zhadzko D. Sauna effect on blood oxygen transport and prooxidant-antioxidant balance in athletes. *MedicinaSportiva: Journal of Romanian Sports Medicine Society*, 2012; 8 (3): 1883,
- 31.Zoladz J.A., Pilc A. The effect of physical activity on the brain derived neurotrophic factor: from animal to human studies. *J PhysiolPharmacol*. 2010; 61(5): 533-41.

# PHYSICAL-MATHEMATICAL SCIENCES

## ECONOPHYSICAL ANALYSIS OF ECONOMIC DEVELOPMENT

<sup>1</sup>Shahlar Gachay Askerov, <sup>2</sup>Tural Khanjiqazov

<sup>1,2</sup>*Baku State University, Baku, Azerbaijan*

*email: [ashahlar@hotmail.com](mailto:ashahlar@hotmail.com)*

*[TuralKhanjiqazovtural.khan@gmail.com](mailto:TuralKhanjiqazovtural.khan@gmail.com)*

### Abstract

The article considers the econophysical analysis of the relationship between monopoly and competition. It is indicated that as a result of mutual influence between two independent monopolistic firms there is competition, and competition is a derivative of monopoly. In a competitive environment, the relationship between production process and time is a non-linear one, as a result of which competition leads to progress. In this case, the variety of output characteristics of a market entity is a consequence of the influence of the market structure. This approach makes it possible to define progress as a term with a unit of measure. Different economic models have been proposed for developing and developed countries. It has been constantly shown that developing countries should obtain latest technology and provide transparent legal system for progress. Developed countries, however, should create new technologies based on science.

**Key Words:** econophysics, competition, monopoly, duopoly, progress, production rate, diode Schottky, revers  $I$ - $V$  characteristic diodes.

### Introduction

Econophysics is a science that learns the nonlinear dynamics of economic processes. The goal is to investigate and forecast the economic development process using methods of physical sciences. In order to solve economic problems it is sometimes useful to apply models, methods, and laws of the science of physics. The term econophysics was first introduced in 1995 by American physicist Harri Eugene Stanley (Mantenga & Stanley, 2000). Even though the age of this science field is approximately 20 years, according to the data, many advanced universities are currently teaching econophysics courses. One of the brightest examples for the application of physics to

solve economic problems is the gravity model of international trade. This model was first introduced to the world of economics in 1954 by Walter Isard (W. Isard, 1954). It is well known that the competition is the driving force of the economy and an important factor in the development of the economy.

Therefore, the interaction between monopoly and competition is widely studied. This problem is considered in the light of the econophysics in this article. In our opinion, some results obtained by us in certain areas of physics can also be applied to a market economy. Such phenomena include low-energy cathode sputtering (Askerov, 1969; 1970) and the reverse branch of the current-voltage characteristic of the Schottky Diodes (Askerov & et.al., 2018). The sputtering coefficient of metals near the threshold region of the ion energy depends on the surface structure and this dependence can be either linear or nonlinear.

The properties of the devices of metal-semiconductor contact also depend on the structure of interface. Thus, the  $I$ - $V$  characteristics of the Schottky diodes in the opposite direction can be linear or non-linear, depending on the structure of interface. In the above-mentioned physical phenomena, the effect of the structure on the property has been perfectly studied. We believe that this mechanism can also be applied to the interaction between monopoly and competition in a market economy. Because the interaction between monopoly and competition depends on the structure of the market. Thus, during the monopoly the production of goods is dependent on time linearly, while during the competition this dependence become nonlinear.

### **Research methods**

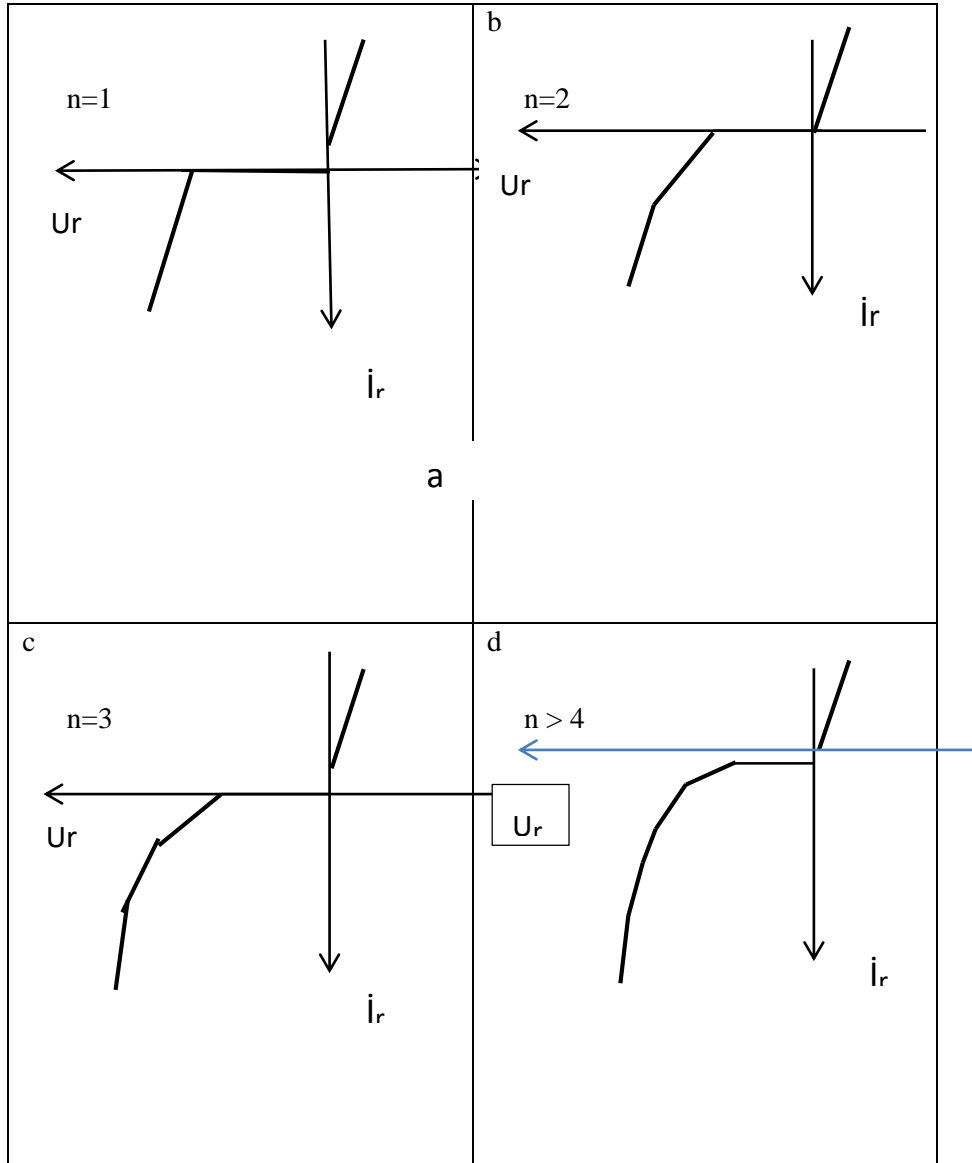
The similarity of mechanisms between the low-energy sputtering and the market economy was studied and reported in: “The Study of the Market Economic Problem by the Method of Econophysics” (Askerov & Askerov, 2018). It was shown that, during cathode sputtering there is a clear interdependence between the structure and the property. Thus, it is possible to alter the properties of the object by changing the structure and to convert its linear output characteristics to non-linear characteristics. As mentioned above, the results obtained in this field have been applied to the market economy. Another physical phenomenon that can be of use in market economy cases is the reverse branch of the current-voltage ( $I$ - $V$ ) characteristic of the Schottky diodes (SD). The Schottky diode is a diode that is formed between a semiconductor and a metal. In this case, the semiconductor must necessarily have a single-crystal structure. However, the metal can also have a polycrystalline structure. This type of diode was researched and implemented over the last hundred years. The reverse branches of the current-voltage characteristics of these diodes vary for their shapes, which are presented

in fig 1. As it is shown in the fig. 1, the shapes of the  $\dot{I}$ -V characteristic have "hard" (fig.1a) and "soft" (fig.1d) breakdowns, and sometimes is observed I-V characteristic with breaks (fig.1, b and c). Fig. 1a shows that the SD has an ideal (hard breakdown) I-V characteristic and the reverse current breaks only at one point. With an increase in the reverse voltage  $U_r$ , the reverse current grows linearly. This means the interface is uniform and not only the semiconductor, but also the metal has a monocrystalline structure. And the diode consists of only one sub-diode. Fig.1b shows that the reverse I-V characteristic is broken at two points. This means that the investigated diode consists of a parallel combination of two sub diodes which have different parameters such as: (i) the breakdown voltage, (ii) diode area and (iii) barrier heights. After breakdown of the first diode, the reverse current rises according to the avalanche breakdown mechanism. When the voltage reaches the breakdown voltage point of the second diode, the second diode breaks, and the reverse current breaks one more time. In the case, when the number of sub diodes is three, the third breaking appears in the reverse current-voltage characteristic (fig.1, c). In the same way, it is possible to explain the I-V characteristic of Schottky diodes when the number of sub diodes is more than 4. Obviously, if the number of sub diodes increases, then the inverse I-V characteristic of the common diode will be nonlinear (fig.1, d). Thus, in the opposite direction, the linearity or nonlinearity of the current-voltage characteristic of a SD diode depends on the degree of inhomogeneity of the interface. By changing the degree of inhomogeneity with (by) the technology, it is possible to change the number of contact-forming sub diodes. Here  $b$  is the proportionality coefficient, which shows the volume of output per unit time. It can be called the *production rate*. At  $b = 0$  there is no production, i.e. the goods are not produced. We can assume that in the case of a pure monopoly,  $b$  remains constant ( $b = b_m = \text{const}$ ) and does not change over time. In this case, we have the production, but we don't have the progress.

To achieve progress, it is necessary that the volume of output per unit of time (production rate) increases nonlinearly with time. In other words, to achieve progress, the linear dependence of  $I(t)$  should become non-linear. This means that the coefficient of progress of proportionality  $b$  (in formula 1) should gradually increase. We believe that this is a *necessary condition* for progress.

The number of sub diodes can be varied by the shape of the I-V characteristic. If  $n = 1$ , the Schottky diode has an ideal "sharp", and if  $n > 4$ , a "soft" current-voltage characteristic. When  $n = 2$  or  $3$ , there are  $\dot{I}$ -V characteristics with 2 or 3 bends. As a result of geometrical addition of linear reverse currents, the common current-voltage characteristic becomes soft, i.e. nonlinear. It can be concluded from the aforementioned that, if the number of sub diodes increases, the angular coefficient of the I-V characteristic increases continuously. As a result, the straight-forward character of the

sub diodes is transformed to become non-linear. According to the author, the above mentioned approach can be applied in the market economy as well.



**Fig.1. Reverse branches of the I-V characteristic of the metal-semiconductor contact.  $U_r$  and  $I_r$  show the reverse voltage and the current flowing through the diodes**

## Results and Discussion

Suppose that the volume of production ( $I$ ) in the case of monopoly is linear dependant (Askerov & Askerov, 2018) on the time ( $t$ ):

$$\dot{I} = b t \quad (1)$$

Fig.2 shows the dependence of the production volume of goods (or services) on time under different market structures. The production activity of the pure monopolist firm is represented by a straight line  $mm$ , while the activity of the second similar firm is shown by the straight line  $dd$ . As it is easy to see, the presence of the second independent producer of identical goods ( $dd$ )

in the market creates competition and the dependence  $\dot{I}(t)$  is transformed from a straight line into a broken line  $1-2$ . If another new independent producer of goods ( $oo$  lines) appears in the market, the competition will increase even more, the number of broken lines will increase to three ( $1-2-3$ ). In the economic theory, the case of  $1-2$  is called *duopoly* and the case  $1-2-3$  is called *oligopoly* (Econophysics, 2007). The angular coefficient  $b$  will respectively increase as the number of firms increases.

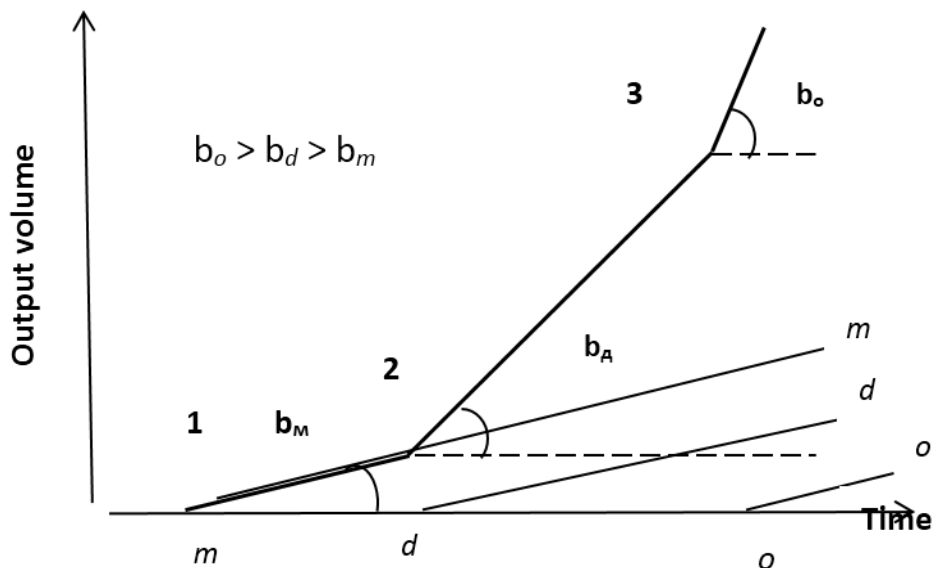


Fig.2. Dependence of the production volume of goods (or service) on time in case of pure monopoly ( $mm$ ), duopoly ( $dd$ ) and oligopoly ( $oo$ ) market structures



The parallelism of the lines  $mm$ ,  $dd$  and  $oo$  in fig.2 means that the technologies used in the production of goods by competing firms are at the same level. In addition, as can be seen from the graph, if the number of competitors grows, the output volume per unit of time will also increase:  $b_o > b_d > b_m$ . Thus, in the presence of competition, the transition process from an absolute monopoly to an imperfect monopoly (oligopoly) makes market more complex, and its output characteristics differs significantly from the output characteristics of individual independent producers in the market.

The increase in the quantity of production per unit of time  $b$  (production rate) in case of duopoly can be represented by the following formula:

$$b_d = b_m + \alpha t \quad (2)$$

Here,  $b_d$  and  $b_m$  are production rates of a duopoly and pure monopolistic firm, respectively;  $\alpha$  is a constant characterizing progress. According to the formula (2), progress can be defined as a production value equal to the change in  $b$  per unit time, and its unit of measurement is the production volume (goods or services) /square of time.

From high school-level physics it is known that, the speed of the alternating motion at any time is defined by the following formula:

$$v_t = v_0 + at \quad (3)$$

Where  $v_t$  is the velocity at time  $t$ , and  $v_0$  is the initial velocity, and  $a$  is the acceleration. It is known from physics that acceleration is a change in velocity in unit time and is measured by a unit: *distance* /  $t^2$ .

Acceleration in the economy characterizes the progress and shows the change of production rate over time and measured by the unit: *production volume* /  $t^2$ .

If we take formula (2) into account in formula (1), we can see that  $\dot{I}$  is nonlinearly time-dependent. Even with perfect competition (many firms) and an identical technology, the amount of output per unit of time proportionally increases over the square of time, which leads to the emergence of progress:

$$\dot{I} = b_m t + \alpha t^2 \quad (4)$$

Under such conditions there is no need for the development of science. It is sufficient to have a high level of university education, and a legal environment for competition. Some countries which belong to so-called emerging economies often choose this way of development. Another factor that strongly influences the progress is, of course, technology. It is well known that technology depends on the level of science.

The need for technological development leads to a greater need for science. For this reason, in developed countries the society allocates big financial resources for science. The relationship between the change in the level of technology ( $\Delta T$ ) and science ( $S$ ) in a certain time interval  $\Delta t$  can be represented in the following form:

$$\Delta T = \kappa_1 S \Delta t \quad (5)$$

where,  $\kappa_1$  is the coefficient of proportionality.

Thus, we can conclude that with the increase in number of competing firms, the types of market structures change, and their sequence from pure monopoly to perfect competition can be represented by the following chain: **Pure monopoly - Duopoly - Oligopoly - Imperfect competition - Perfect competition.**

To conclude, the relationship between monopoly and competition is very simple and there is no contradiction between them. Initially, the market is born as a monopoly, and then analogical firms are created, competition among firm's starts. From the foregoing, it can be concluded that in order to achieve progress, over time the nonlinear pattern of production is *important*. To do this, it is *sufficient* to have a number of firms interacting with each other under the influence of competition.

It is noted that if the number of firms grows, the market is subject to the law of complex systems (Peter Richmond et. al, 2013). By acquiring technology and creating conditions for competition in the market, one can achieve progress even without having a strong science. In other words, free competition and strong antitrust laws are very important for the economic growth of countries. Technology is a factor that strongly influences the progress. There is a great need for science in order to develop the technology. Science is a very strong factor that influences the nonlinearly changing growth of the economy. Scientists are subjects that develop the science. Scientists are generators of ideas, they stand at the center of world development. In many developed countries, the scientist's daily salary is calculated for 24 hours a day and is quite high. In developing countries, the salary of a scientist is equal to the wage of a civil servant and is calculated at 8 hours per day and is not enough.

Therefore, the flow of scientists from the developing countries to the developed world countries occurs. It is shown that with the increase in the number of competing firms, the types of market structures change, and their sequence from pure monopoly to perfect competition can be represented by the following chain: pure monopoly-duopoly-oligopoly-pure competition and again a monopoly suddenly occur as a result technological advancement. From above mentioned points, we can offer two different models for economic development. Models of developing and developed countries are

significantly different. High technology is imported from abroad and transparent legal environment leads to competition. For this country sufficient to have a high level of university education. In this case, however, the level of economic growth and progress are not at the desired level. In the model of developed countries, science has an exceptional place and creates new technologies. Serious anti-monopoly laws are applied. In such a situation rapid development, in other words, progress is inevitable. Models for developing and developed countries vary significantly. In developing countries technology is obtained from abroad and transparent legal system leads to competition. Under these conditions, there is economic development and progress, even though below desired levels.

### **Conclusion**

It is clear from the above that there is no conflict or "magic hand" between monopoly and competition, there is a natural and mutual relationship in the market. Like an electric charge that creates an electric field around itself, each company creates its own "market field" and interacts with each other through this field. From this study, the following results are obtained:

1. In order to achieve progress, it is *necessary* to bring together several firms that produce the same product (service). This makes contracting companies a complex system and creates a significantly competitive environment. Unlike the straight line characteristics of monopoly firms, the output characteristic of the complex system is nonlinear.
2. Another important condition for progress is the protection of entrepreneurs from monopolies, i.e., need for antimonopoly legislation.
3. As a result of the research, the term "progress" has a new meaning, indicating an increase in production rate over a unit of time, and measured by the *production volume/square of the time*.
4. Technology is key to economic development. It is possible to acquire technology, create a competitive environment and achieve progress. There is no need for serious science, it is sufficient to have a high level of university education.
5. However, advanced technology is essential for rapid economic development. Technology is obtained through science, and the science is led by scientists. Hence, scientists are at the center of development. This fact is well understood by developed countries. This result is not new, since the value of scientists has been understood by the society since many centuries.

## References

1. Askerov, Sh.G., and SenaL.A, (1969), Cathode sputtering of metals by slow mercury ions, Sov.
2. Phys.-Solid State (Engl. Transl.) 11: 1288-1293,(Translated from Fiz.Tverd.Tela; 11:1591-1597.
3. Askerov, Sh.G. Gasanov, M.G, Abdullayeva, L.K, (2018). The influence of the metal
4. Microstructure on the breakdown mechanism of schottky diodes Materials Physics and
5. Chemistry, Volume 1 doi:10.63019/mpc.v1i2.124
6. Askerov Sh.G., Askerov A.Sh. The study of the Market Economy Problem by the metod of Econophysics 4th International Conference on Global Issues in Multidisciplinary Academic Research, February 01-02, 2018, Tokyo, Japan
7. Econophysics, (2007) Modern physics in search of economic theory / ed. V.V. Kharitonov and A.L.Ezhova. M.: MĪPhĪ, 624 p.
8. Peter Richmond, Jurgen Mimkes and Stefan Hutzler (2013) Econophysics and Physical Economics, Oxford university press, 243
9. Mantenga R.N., Stanley H.E. (2000). An introduction to Econophysics: Correlations and
10. Complexity in Finance. Cambridge University Press, 147 p.
11. Walter Isard, (1954). "Location Theory and Trade Theory: Short-Run Analysis". Quarterly Journal of Economics. 68 (2): 305.

## OPTIMAL CONTROL OF STURM-LIOUVILLE TYPE DIFFERENTIAL INCLUSIONS WITH FUNCTIONAL CONSTRAINTS

<sup>1</sup>E.N. Mahmudov\*, <sup>2</sup>D.I. Mastaliyeva\*\*

*\*International Academy of Science, Azerbaijan Section,*

*\*Department of Mathematics, Istanbul Technical University, Istanbul, Turkey,*

*\*\*Azerbaijan National Academy of Sciences Institute of Control Systems, Baku, Azerbaijan*

*E-mail: elimhan22@yahoo.com, dilara.mesteliyeva@gmail.com*

*This paper is dedicated to the memory of Professor Lotfi A. Zadeh (1921-2017),  
Founder of Fuzzy logic and Fuzzy Mathematics*

## Abstract

The paper studies a new class of problems of optimal control theory with linear second order self-adjoint Sturm-Liouville type differential operators and with functional

and non-functional endpoint constraints. Sufficient conditions of optimality, containing both the second order Euler-Lagrange and Hamiltonian type inclusions are derived. The presence of functional constraints generates special second order transversality inclusions and complementary slackness conditions peculiar to inequality constraints; this approach and results make a bridge between optimal control problem with Sturm-Liouville type differential inclusions and constrained mathematical programming problems in finite-dimensional spaces. The idea for obtaining optimality conditions is based on applying locally-adjoint mappings to Sturm-Liouville type set-valued mappings. The result generalizes to the problem with a second order non-self-adjoint differential operator.

**Keywords:** Sturm-Liouville, functional, transversality, complementary slackness, Hamiltonian.

**AMS Subject Classifications,** 34A60, 34G25, 65K05, 90C25.

### **Introduction**

Optimal control of discrete-differential inclusions with lumped and distributed parameters has been expanding in all directions at an astonishing rate during the last few decades. Note that the differential inclusions are not only models for many dynamical processes but they also provide a powerful tool for various branches of mathematical analysis; see more discussions and comments in the relatively recent publications [5, 6, 8, 13, 15, 17] and the references therein. Notice that first order differential inclusions play a crucial role in the mathematical theory of optimal processes given in the next papers [4, 5, 8, 12, 18, 19]. Closely related optimality problems for a first order differential inclusions were considered by Rockafellar [5] and Mordukhovich [12] and the present study is an important generalization of their works to the problem with Sturm-Liouville type differential inclusions. In the paper [5] are considered a Mayer problem of optimal control, whose dynamic constraint are given by a convex-valued first order differential inclusions.

Both state and endpoint constraints are involved. Are proved necessary conditions incorporating the Hamiltonian inclusion, the Euler-Lagrange inclusion, and the Pontryagin maximum condition. These results weaken the hypotheses and strengthen the conclusions of earlier works. The paper [12] is devoted to the study of a Mayer-type optimal control problem for semilinear unbounded evolution inclusions in reflexive and separable Banach spaces subject to endpoint constraints described by finitely many Lipschitzian equalities and inequalities. First are constructed a sequence of discrete approximations to the optimal control problem for evolution inclusions and proved that

optimal solutions to discrete approximation problems uniformly converge to a given optimal solution for the original continuous-time problem.

The paper [18] deals with the exact controllability for impulsive fractional semilinear functional differential inclusions in Hilbert spaces. Under suitable assumptions, the exact controllability of the control systems are formulated and proved. The main tools in this study rely on the fixed point theorem for multivalued maps due to Dhage associated with evolution systems. The paper [19] proposes a new method to determine the viability of linear differential inclusions on an unbounded polyhedron. Based on nonsmooth analysis and viability theory, a sufficient and necessary condition of viability for a convex cone is presented and the result are applied to an autonomous continuous-time positive linear system and a continuous-time positive linear system with scalar inputs. Moreover, a sufficient condition that guarantees the viability of linear differential inclusions on an unbounded polyhedron is given. In fact, the difficulty in the problems with second order ordinary differential inclusions is rather to construct the Euler-Lagrange type second order adjoint inclusions and the suitable boundary of so-called transversality conditions.

That is why on the whole in literature only the qualitative properties of second order differential inclusions are investigated (see [1,16] and references therein). The article [1] studies the three-point boundary value problems for second-order perturbed differential inclusions of the form  $u''(t) \in F(t, u(t), u'(t)) + H(t, u(t), u'(t))$  a.e. on  $[0,1]$ . The existence of solutions is proved under nonconvexity condition for the set-valued mapping  $H$ . Here it is assumed that  $F : [0,1] \times E \times E \rightrightarrows E$  ( $E$  is a separable Banach space) is upper semicontinuous on  $E \times E$  and such that, for any fixed  $(x, y)$  in  $E \times E$ , the set-valued mapping  $F(\cdot, x, y)$  has a measurable graph,  $H : [0,1] \times E \times E \rightrightarrows E$  is a set-valued mapping with a measurable graph and closed values, lower semicontinuous on  $E \times E$ . The paper [16] is concerned with the nonlinear boundary value problems for a class of semilinear second order differential inclusions, are given some existence theorems of solutions in the convex case. A notion of solution tube to these problems is used here to give priori bounds for the solutions of auxiliary inclusions.

In spite of the presence of the above mentioned qualitative studies, optimal control of problems with the higher order DFIs has not been studied in the literature; up to our best knowledge, there a few papers of Mahmudov [7-11] devoted to such studies. The paper [9] concerns itself with the second order polyhedral optimization described by ordinary discrete and differential inclusions. The stated second order discrete problem is reduced to the polyhedral minimization problem with polyhedral geometric constraints and necessary and sufficient conditions of optimality are derived in terms of

the polyhedral Euler-Lagrange inclusions. The paper [11] studies a new class of problems of optimal control theory with Sturm-Liouville type differential inclusions involving second order linear self-adjoint differential operators. Necessary and sufficient conditions, containing both the second order Euler-Lagrange and Hamiltonian type inclusions and “transversality” conditions are derived.

The result strengthens and generalizes to the problem with a second order non-self-adjoint differential operator; a suitable choice of coefficients then transforms this operator to the desired Sturm-Liouville type problem.

The present paper is dedicated to one of the most difficult and interesting fields – optimization of the second order Sturm-Liouville (S-L)-type differential inclusions with functional and non-functional endpoint constraints. Various applications of the Sturm-Liouville Oscillation Theory to differential equations and spectral theory play a significant role in modern mathematics and, thus, the problem is of high interest to the scientific community.

To the best of our knowledge, there is no paper which considers optimality conditions for these problems in the literature and we aim to fill this gap. It should be noted that there are papers [2, 3] in the literature devoted to the study of some qualitative properties of the second order (S-L)-type differential inclusions. In the paper [3] are considered a second-order differential inclusion and are obtained sufficient conditions for  $h$ -local controllability along a reference trajectory.

The problems posed in the present paper and the corresponding optimality conditions are new and organized in the following order; in Section 2, the needed facts and supplementary results from the book of Mahmudov [8] are summarized for the reader’s convenience. In particular, Hamiltonian function, argmaximum sets of a set-valued mapping, the locally-adjoint mapping (LAM) are introduced and the (S-L) problem for differential inclusions is formulated. In Section 3, sufficient conditions of optimality for (S-L) problem are derived. The right-hand side of the transversality inclusion and complementary slackness condition will surprise any one working in the field because this approach and results make a bridge between optimal control problem with higher order differential inclusion (S-L) and constrained mathematical programming problems in finite-dimensional spaces.

Thus, using LAM we deduce the sufficient conditions of optimality for (S-L) problem in second order Euler-Lagrange forms. In addition, under the closedness condition of set-valued mapping, the optimality conditions for the (S-L) problem are derived in terms of Hamiltonian function in the much more pleasant form. Note that the basic idea in the paper for the continuous problem (S-L) was to replace it by the discrete-approximate problem and then by passing to the limit to formulate sufficient conditions optimality for the original problem. In this paper establishment of these conditions is

omitted and we start our discussion with sufficient optimality conditions for problem (S-L). And in this sense the obtained results of Section 3 as well as of the next sections are only the visible part of the “icebergs”. In Section 4 is investigated a Bolza problem with non-self-adjoint second order linear differential operator and with functional and non-functional endpoint constraints.

A sufficient condition of optimality is formulated in term of second order an adjoint linear differential operator with variable coefficients. A suitable choice of coefficients then transforms this operator to the desired Sturm-Liouville type operator. In particular, if a positive-valued, scalar function specific to Sturm-Liouville differential inclusions is identically equal to one, we have immediately the optimality conditions for the second order differential inclusions. In Section 5 the optimality conditions are given for a Bolza problem with a more general second order differential inclusions. The basic difference of this problem is that here set-valued mapping depend not only on sought function, but on its derivative, too. This fact seriously complicates the construction of proof of optimality conditions for higher order differential inclusions. These obtained conditions involve useful forms of the Pontryag in maximum condition [14] and second order Euler-Lagrange type adjoint inclusions. As example, we consider a Mayer problem with a semilinear second order continuous-time evolution inclusions and missing non-functional endpoint constraint. In addition, numerical computation developed for a Mayer problem with particular case of Newton’s second law of motion.

## **2. Needed facts and Problem Statement**

The necessary notions can be found in the monograph of Mahmudov [8]. Let  $\mathbb{R}^n$  be  $n$  dimensional Euclidean space,  $\langle x, y \rangle$  be an inner product of elements  $x, y \in \mathbb{R}^n$ ,  $(x, y)$  be a pair of  $x, y$ . Assume we are given the evolution set-valued mapping  $F(\cdot, t) : \mathbb{R}^n \times \mathbb{R}^n \rightrightarrows \mathbb{R}^n$ ,  $t \in [t_0, t_1]$ . Then  $F(\cdot, t)$  is convex, if its graph  $gph F(\cdot, t) := \{(x, y, z) : z \in F(x, y, t)\}$  is a convex subset of  $\mathbb{R}^{3n}$ .  $F(\cdot, t)$  is convex and closed, if its graph is a convex and closed set in  $\mathbb{R}^{3n}$

$F(\cdot, t)$  is convex and closed, if its graph is a convex and closed set in  $\mathbb{R}^{3n}$ . The domain of  $F(\cdot, t)$  is denoted by  $dom F(\cdot, t) = \{(x, y) : F(x, y, t) \neq \emptyset\}$ .  $F(\cdot, t)$  is convex-valued, if  $F(x, y, t)$  is a convex set for each  $(x, y) \in dom F(\cdot, t)$  Let us introduce the Hamiltonian function and argmaximum set for a set-valued mapping  $F(\cdot, t)$



$$H_{F(\cdot,t)}(x, y, z^*) = \sup_z \left\{ \langle z, z^* \rangle : z \in F(x, y, t) \right\}, \quad z^* \in \mathbb{R}^n,$$

$$F_A(x, y; z^*, t) = \left\{ z \in F(x, y, t) : \langle z, z^* \rangle = H_{F(\cdot,t)}(x, y, z^*) \right\},$$

respectively. For convex  $F(\cdot, t)$  we set  $H_{F(\cdot,t)}(x, y, z^*) = -\infty$ , if  $F(x, y, t) = \emptyset$ .

The convex cone  $K_A(x, y, z)$ ,  $(x, y, z) \in A$  is called the cone of tangent directions at a point  $(x, y, z) \in A$  to the set  $A$ , if from  $(\bar{x}, \bar{y}, \bar{z}) \in K_A(x, y, z)$  it follows that  $(\bar{x}, \bar{y}, \bar{z})$  is a tangent vector to the set  $A$  at point  $(x, y, z) \in A$ , i.e., there exists such function  $\eta: \mathbb{R}^1 \rightarrow \mathbb{R}^{3n}$  that  $(x, y, z) + \lambda(\bar{x}, \bar{y}, \bar{z}) + \eta(\lambda) \in A$  for sufficiently small  $\lambda > 0$  and  $\lambda^{-1}\eta(\lambda) \rightarrow 0$ , as  $\lambda \downarrow 0$ .

Obviously, on the definition the cone of tangent directions cannot be nonconvex; it should be pointed out that the cone of tangent directions is not uniquely defined. In any case the wider a cone of tangent directions the essentially optimality conditions.

In general, for a set-valued mapping  $F(\cdot, t)$  a set-valued mapping  $F^*(\cdot; x, y, z, t): \mathbb{R}^n \rightrightarrows \mathbb{R}^{2n}$  defined by

$$F^*(z^*; (x, y, z), t) := \left\{ (x^*, y^*) : (x^*, y^*, -z^*) \in K_{\text{gph} F(\cdot,t)}^*(x, y, z) \right\},$$

is called the LAM to the set-valued mapping  $F(\cdot, t)$  at a point  $(x, y, z) \in \text{gph} F(\cdot, t)$ , where  $K_{\text{gph} F(\cdot,t)}^*(x, y, z)$  is the dual to the cone of tangent directions  $K_{\text{gph} F(\cdot,t)}(x, y, z)$  [20].

We provide another definition of LAM to nonconvex mapping  $F(\cdot, t)$  which is more relevant for further development

$$F^*(z^*; (x, y, z), t) := \left\{ (x^*, y^*) : H_{F(\cdot,t)}(x_1, y_1, z^*) - H_{F(\cdot,t)}(x, y, z^*) \leq \langle x^*, x_1 - x \rangle + \langle y^*, y_1 - y \rangle, \forall (x_1, y_1) \in \mathbb{R}^{2n} \right\}, \quad (x, y, z) \in \text{gph} F(\cdot, t), \quad z \in F_A(x, y, z^*, t).$$

Clearly, for the convex mapping the Hamiltonian  $H_{F(\cdot,t)}(\cdot, z^*)$  is concave and the latter and previous definitions of LA Mscoincide.

In Section 3 is considered a Bolza problem with Sturm-Liouville type evolution differential Inclusions and with functional and non-functional constraints:

$$\text{minimize } J[x(\cdot)] = \int_{t_0}^{t_1} g(x(t), t) dt + \varphi_0(x(t_1), x'(t_1)), \quad (1)$$

$$(S-L) (p(t)x'(t))' \in F(x(t), t), \text{ a.e. } t \in [t_0, t_1], \quad (2)$$

$$\varphi_k(x(t_1), x'(t_1)) \leq 0, k = 1, \dots, r; \quad (3)$$

$$x(t_0) = \alpha_0, x'(t_0) = \alpha_1, (x(t_1), x'(t_1)) \in Q \quad (4)$$

Here  $F(\cdot, t) : \mathbb{R}^n \rightrightarrows \mathbb{R}^n$  is a time dependent set-valued mapping,  $g(\cdot, t) : \mathbb{R}^n \rightarrow \mathbb{R}^1$  and  $\varphi_k : \mathbb{R}^{2n} \rightarrow \mathbb{R}^1 (k = 0, \dots, r)$  are continuous functions,  $p : [t_0, t_1] \rightarrow (0, \infty)$  is continuously differentiable function,  $Q \subseteq \mathbb{R}^{2n} = \mathbb{R}^n \times \mathbb{R}^n$  is nonempty subset,  $Ax \equiv (px')'$  is a second order Sturm-Liouville operator. The problem is to find an arc  $\tilde{x}(\cdot)$  of the problem (1)-(4) satisfying (2) almost everywhere (a.e.) on  $[t_0, t_1]$  and the functional (3) and non-functional (4) constraints at minimizes the Bolza functional  $J[x(\cdot)]$ . We label this problem as (S-L). First we derive sufficient optimality conditions in the convex problem and then generalize the obtained results to the nonconvex case. Here, a feasible trajectory  $x(\cdot)$  is understood to be an absolutely continuous function on a time interval  $[t_0, t_1]$  together with the first order derivatives for which  $x''(\cdot) \in L_1^n$ . Obviously, such class of functions is a Banach space, endowed with the differentequivalent norms.

Note that the second order Sturm-Liouville operator  $A$  is a well-known example of a self-adjoint operator, i.e.,  $A^* x^* = px^{*''} + p'x^{*'}$ . As is known, in mathematics, this operator is central to Sturm-Liouville where the eigen functions (analogues to eigenvectors) of this operator are considered.

### 1. Sufficient Conditions of Optimality for (S-L) Problem with endpoint constraints

Let us explain the principal method that we use to obtain the sufficient condition of optimality for the above posed problem (S-L); the basic idea is to replace the continuous problem (S-L) by the discrete-approximate problem that can be studied effectively, and then by passing to the limit to formulate sufficient conditions optimality for the original problem. In this paper establishment of these conditions is omitted and we start our discussion with a presentation of sufficient optimality conditions for problem (S-L). And in this sense the obtained results of paper are only the visible parts of the “icebergs”. In this way we establish so-called the second order (S-L) type Euler-Lagrange and transversality inclusions and the complementary slackness conditions.

The second order Euler-Lagrange differential inclusion

$$(i) \left( p(t)x^{*'}(t) \right)' \in F^* \left[ x^*(t); (\tilde{x}(t), (p(t)\tilde{x}'(t))'), t \right] - \partial g(\tilde{x}(t), t), \text{ a.e. } t \in [t_0, t_1].$$

The second order transversality condition for endpoint constraints at  $t = t_1$

$$(ii) \quad p(t_1) \left( x^{*'}(t_1), -x^*(t_1) \right) \in \partial \varphi_0(\tilde{x}(t_1), \tilde{x}'(t_1)) + \sum_{k=1}^{k=r} \lambda_k \partial \varphi_k(\tilde{x}(t_1), \tilde{x}'(t_1)) - K_Q^*(\tilde{x}(t_1), \tilde{x}'(t_1)).$$

The complementary slackness conditions at  $t = t_1$  (iii)

$$\lambda_k \varphi_k(\tilde{x}(t_1), \tilde{x}'(t_1)) = 0, \lambda_k \geq 0, k = 1, \dots, r.$$

In what follows, we refer to  $\lambda_k$  as the Lagrange multiplier [16, 17] associated with the  $k$ -th inequality constraint  $\varphi_k(x(t_1), x'(t_1)) \leq 0$  and usually  $\lambda_{k_0} > 0$ , if  $\varphi_{k_0}(x(t_1), x'(t_1)) = 0$  and  $\lambda_{k_0} = 0$  if  $\varphi_{k_0}(x(t_1), x'(t_1)) < 0$  for a some  $k_0$ . Moreover,  $K_Q^*(\tilde{x}(t_1), \tilde{x}'(t_1))$  is the dual to the cone

of tangent directions  $K_Q(\tilde{x}(t_1), \tilde{x}'(t_1)), (\tilde{x}(t_1), \tilde{x}'(t_1)) \in Q \subseteq \mathbb{R}^{2n}$ . We assume that  $x^*(t), t \in [0, 1]$

is absolutely continuous function together with the first order derivative and  $x^{*''}(\cdot) \in L_1^n$

. It should be noted that the LAM  $F^*$  is nonempty at a given point provided that

$$(iv) (p(t)\tilde{x}'(t))' \in F_A(\tilde{x}(t), x^*(t), t), \text{ a.e. } t \in [0, 1].$$

It turns out that the following assertion is true.

**Theorem 3.1** Suppose that  $\varphi_k : \mathbb{R}^{2n} \rightarrow \mathbb{R}^1, k = 0, 1, \dots, r$  are convex continuous functions,  $F(\cdot, t)$  is an evolution convex set-valued mapping and  $Q \subseteq \mathbb{R}^{2n}$  is a convex set. Then for optimality of the trajectory  $\tilde{x}(\cdot)$  in the (S-L) problem it is sufficient that there exists an absolutely continuous function  $x^*(t), t \in [t_0, t_1]$  to gether with the first order derivative and not all zero Lagrange multipliers  $\lambda_k \geq 0, k = 0, \dots, r, (\lambda_0 = 1)$ , satisfying *a.e.* the second order (S-L) type Euler-Lagrange inclusion (i), the transversality condition (ii) and the complementary slackness conditions (iii) at  $t = t_1$ .

*Proof.* By Theorem 2.1 [8, p.62] we have  $F^*(z^*; (x, z), t) = \partial_x H_{F(\cdot, t)}(x, z^*)$ ,  $z \in F_A(x, z^*, t)$ . Then from the Euler-Lagrange inclusion (i) we obtain the second order adjoint differential inclusion

$$(p(t)x^{**'}(t))' \in \partial_x [H_{F(\cdot, t)}(\tilde{x}(t), x^*(t)) - g(\tilde{x}(t), t)], \text{ } t \in [t_0, t_1], \text{ which means that}$$

$$H_{F(\cdot, t)}(x(t), x^*(t)) - g(x(t), t) - [H_{F(\cdot, t)}(\tilde{x}(t), x^*(t)) - g(\tilde{x}(t), t)] \leq \langle (p(t)x^{**'}(t))', x(t) - \tilde{x}(t) \rangle.$$

Then by using the definition of Hamiltonian function and the condition (iv) we have

$$\langle (p(t)x'(t))' - (p(t)\tilde{x}'(t))', x^*(t) \rangle - g(x(t), t) + g(\tilde{x}(t), t) \leq \langle (p(t)x^{**'}(t))', x(t) - \tilde{x}(t) \rangle. \quad (5)$$

Let us integrate (5) over the interval  $[t_0, t_1]$

$$\int_{t_0}^{t_1} [\langle (p(t)x'(t))' - (p(t)\tilde{x}'(t))', x^*(t) \rangle - \langle (p(t)x^{**'}(t))', x(t) - \tilde{x}(t) \rangle] dt \leq \int_{t_0}^{t_1} [g(x(t), t) - g(\tilde{x}(t), t)] dt.$$

It can be easily seen that integration by parts on the left-hand side of this inequality (here is taken into account that  $x(t)$  and  $\tilde{x}(t), t \in [t_0, t_1]$  are feasible trajectories) give

us

$$\int_{t_0}^{t_1} \left[ \left\langle (p(t)x'(t))' - (p(t)\tilde{x}'(t))', x^*(t) \right\rangle - \left\langle (p(t)x^{*'}(t))', x(t) - \tilde{x}(t) \right\rangle \right] dt$$

$$= p(t_1) \left[ \left\langle x'(t_1) - \tilde{x}'(t_1), x^*(t_1) \right\rangle - \left\langle x^{*'}(t_1), x(t_1) - \tilde{x}(t_1) \right\rangle \right] \quad (6)$$

Then by virtue of (6) the above inequality can be transformed into inequality

$$\int_{t_0}^{t_1} [g(x(t), t) - g(\tilde{x}(t), t)] dt \geq p(t_1) \left[ \left\langle x'(t_1) - \tilde{x}'(t_1), x^*(t_1) \right\rangle - \left\langle x^{*'}(t_1), x(t_1) - \tilde{x}(t_1) \right\rangle \right] \quad (7)$$

Now recall that on the definition of dual cone for all pair  $(x^*(t_1), x^{*'}(t_1)) \in K_Q^*(\tilde{x}(t_1), \tilde{x}'(t_1))$  the functional transversality condition (ii) of theorem implies

$$\varphi_0(x(t_1), x'(t_1)) + \sum_{k=1}^r \lambda_k \varphi_k(x(t_1), x'(t_1)) - \varphi_0(\tilde{x}(t_1), \tilde{x}'(t_1)) - \sum_{k=1}^r \lambda_k \varphi_k(\tilde{x}(t_1), \tilde{x}'(t_1))$$

$$\geq p(t_1) \left[ \left\langle x^{*'}(t_1), x(t_1) - \tilde{x}(t_1) \right\rangle - \left\langle x^*(t_1), x'(t_1) - \tilde{x}'(t_1) \right\rangle \right]. \quad (8)$$

Thus from the inequalities (7) and (8) thereby we get

$$\int_{t_0}^{t_1} [g(x(t), t) - g(\tilde{x}(t), t)] dt + \varphi_0(x(t_1), x'(t_1)) + \sum_{k=1}^r \lambda_k \varphi_k(x(t_1), x'(t_1))$$

$$- \varphi_0(\tilde{x}(t_1), \tilde{x}'(t_1)) - \sum_{k=1}^r \lambda_k \varphi_k(\tilde{x}(t_1), \tilde{x}'(t_1)) \geq 0. \quad (9)$$

Recall that  $x(\cdot)$  is a feasible solution and  $\lambda_k \geq 0, k = 1, \dots, r$ , that is,

$$\sum_{k=1}^{k=r} \lambda_k \varphi_k(x(t_1), x'(t_1)) \leq 0. \text{ Hence, using the complementary slackness conditions}$$

(iii) at  $t = t_1$  for an arbitrary feasible  $s x(\cdot)$  from (9) we have, that is

$J[x(t)] \geq J[\tilde{x}(t)], \forall x(t), t \in [t_0, t_1]$  i.e.  $\tilde{x}(\cdot)$  is optimal.  $\square$

**Remark 3.1** We note that if non-functional constraint is inactive, i.e.,  $Q = \mathbb{R}^{2n}$ , then  $K_Q^*(\tilde{x}(t_1), \tilde{x}'(t_1)) = \{(0, 0)\}$ . Therefore, the transversality inclusion (ii) for functional constraints is  $p(t_1)(x^*(t_1), -x^*(t_1)) \in \partial\varphi_0(\tilde{x}(t_1), \tilde{x}'(t_1)) + \sum_{k=1}^{k=r} \lambda_k \partial\varphi_k(\tilde{x}(t_1), \tilde{x}'(t_1))$  and the in equality (8)

is simplified as follows

$$\varphi_0(x(t_1), x'(t_1)) - \varphi_0(\tilde{x}(t_1), \tilde{x}'(t_1)) \geq p(t_1) \left[ \left\langle x^*(t_1), x(t_1) - \tilde{x}(t_1) \right\rangle - \left\langle x^*(t_1), x'(t_1) - \tilde{x}'(t_1) \right\rangle \right],$$

which implies again that

$$J[x(t)] \geq J[\tilde{x}(t)], \forall x(t), t \in [t_0, t_1].$$

**Remark 3.2** Suppose now that the functional conditions

$\varphi_k(x(t_1), x'(t_1)) \leq 0, k = 1, \dots, r$  of problem (S-L) are missing, for example  $\varphi_k(x(t_1), x'(t_1)) \equiv 0$  and the conditions (3) always hold.

Then instead of transversality inclusion (ii) we have

$$p(t_1)(x^*(t_1), -x^*(t_1)) \in \partial\varphi_0(\tilde{x}(t_1), \tilde{x}'(t_1)) - K_Q^*(\tilde{x}(t_1), \tilde{x}'(t_1)).$$

Then the inequality (10) is replaced by  $J[x(t)] - J[\tilde{x}(t)] \geq 0, \forall x(\cdot)$ , as was to be proved. And obviously, the complementary slackness conditions (iii) at  $t = t_1$  is not required.

**Corollary 3.1** Suppose that the conditions of Theorem 3.1 are satisfied. Then by a particular choice of function  $p$  as  $p(t) \equiv 1, t \in [t_0, t_1]$  for the problem (S-L) the second order Euler-Lagrange inclusion and the transversality condition of Theorem 3.1 for functional constraints at  $t = t_1$  consist of the following

$$(i) x^{**}(t) \in F^* \left[ x^*(t); (\tilde{x}(t), \tilde{x}''(t)), t \right] - \partial g(\tilde{x}(t), t), \text{ a.e. } t \in [t_0, t_1],$$

$$(ii) \left( \frac{d x^*(t_1)}{dt}, -x^*(t_1) \right) \in \partial \varphi_0(\tilde{x}(t_1), \tilde{x}'(t_1)) + \sum_{k=1}^r \lambda_k \partial \varphi_k(\tilde{x}(t_1), \tilde{x}'(t_1)).$$

*Proof.* Since  $p(t) \equiv 1, t \in [t_0, t_1]$  and  $p(t_1) = 0$  then  $(p(t)\tilde{x}'(t))' = \tilde{x}''(t)$  ,  
 $(p(t)x^{*'}(t))' = x^{*''}(t)$

we have immediately the needed result.  $\square$

**Corollary 3.2** In addition to assumptions of Theorem 3.1 let  $F(\cdot, t)$  be a closed set-valued evolution mapping. Then, the conditions (i), (iii) of Theorem 3.1 can be rewritten in term of Hamiltonian function as follows

$$\left( p(t)x^{*'}(t) \right)' \in \partial_x \left[ H_{F(\cdot, t)}(\tilde{x}(t), x^*(t)) - g(\tilde{x}(t), t) \right];$$

$$\left( p(t)\tilde{x}'(t) \right)' \in \partial_z H_{F(\cdot, t)}(\tilde{x}(t), x^*(t)), t \in [t_0, t_1]$$

**Corollary 3.3**To illustrate how to apply the results of Theorem 3.1 consider the example; suppose now we have a Mayer problem with a semilinear second order continuous-time evolution inclusions:

$$\begin{aligned} \text{minimize } & J[x(\cdot)] = \varphi_0(x(t_1), x'(t_1)), x''(t) \in F(x(t), x'(t), t), a.e. t \in [t_0, t_1], \\ & F(x, y, t) = A_1(t)x + A_2(t)y + B(t)U, \varphi_k(x(t_1), x'(t_1)) \leq 0, k = 1, \dots, r; x(t_0) = \alpha_0, \\ & x'(t_0) = \beta_1 \end{aligned} \quad (10)$$

where  $\varphi_k, k = 0, \dots, r$  are convex continuous functions,  $A_i(t), i = 1, 2, B(t)$  are  $n \times n$  and  $n \times r$  continuous matrices, respectively,  $U$  is a continuous matrices, respectively,  $U$  is a convex closed subset of  $\mathbb{R}^r$ . It is required to find a

controlling parameter  $\tilde{u}(t) \in U$  such that the corresponding trajectory  $\tilde{x}(\cdot)$  minimizes  $J[x(\cdot)]$ .

Then according to Theorem 3.1 the Euler-Lagrange inclusion is  $x^{*''}(t) + v^{*'}(t) = A_1^*(t)x^*(t), v^*(t) = A_2^*(t)x^*(t)$ . Differentiating second equation and

substituting into first equation we immediately have the second order adjoint equation and Pontryagin in maximum condition

$$x^{*''}(t) = -A_2^*(t)x^{*'}(t) + A_1^*(t)x^*(t) \text{ a.e. } t \in [t_0, t_1];$$

$$\langle B\tilde{u}(t), x^*(t) \rangle = \sup_{u \in U} \langle B(t)u, x^*(t) \rangle. \text{ The transversality conditions}$$

$$(A_2^*(t)x^*(t_1) + x^{*'}(t_1), -x^*(t_1)) \in \sum_{k=0}^{k=r} \lambda_k \partial \varphi_k(\tilde{x}(t_1), \tilde{x}'(t_1)), \lambda_k \geq 0$$

( $\lambda_0 = 1$ ),  $k = 1, \dots, r$  is an immediate consequence of the conditions of Theorem 3.1.

□

Now we consider the optimization of Bolza problem with differential inclusions described by non-self-adjoint second order linear differential operators:

$$\text{minimize } J[x(\cdot)] = \int_{t_0}^{t_1} g(x(t), t) dt + \varphi_0(x(t_1), x'(t_1)),$$

$$(PSL) \quad Bx(t) \in F(x(t), t), \text{ a.e. } t \in [t_0, t_1], x(t_0) = \alpha_0, x'(t_0) = \alpha_1,$$

$$\varphi_k(x(t_1), x'(t_1)) \leq 0, k = 1, \dots, r; (x(t_1), x'(t_1)) \in Q,$$

where  $Bx = s(t)x'' + q(t)x' = s(t)D^2x + q(t)Dx$  ( $D^k$ ,  $k = 1, 2$  is  $k$ -th order derivatives) in general, is a non-self-adjoint second order linear differential operator with variable continuous

$k$ -th order differentiable coefficients  $s(\cdot), q(\cdot): [t_0, t_1] \rightarrow \mathbb{R}^1$ . Here  $F(\cdot, t)$  is an evolution set-valued mapping,  $\varphi_k, k = 0, \dots, r$  are continuous functions, and  $Q$  is nonempty subset of  $\mathbb{R}^{2n}$ . It

Here  $F(\cdot, t)$  is an evolution set-valued mapping,  $\varphi_k, k = 0, \dots, r$  are continuous functions, and  $Q$  is nonempty subset of  $\mathbb{R}^{2n}$ . It can be noted that in the particular case, if  $s(t) = p(t)$ ,  $q(t) = p'(t)$ , where  $p(\cdot): [t_0, t_1] \rightarrow (0, \infty)$  the second order linear differential operator,  $B$  is self-adjoint and the (S-L) and (PSL) problems coincide. This property can be proven using the formal adjoint definition:



$$B^* x^* = D^2(sx^*) - D(qx^*) = (px^*)'' - (p'x^*)' = px^{*''} + p'x^{*'} = sx^{*''} + qx^{*'}.$$

For simplicity we consider a convex problem (PSL).

**Theorem 4.1** Suppose that  $\varphi_k : \mathbb{R}^{2n} \rightarrow \mathbb{R}^1, k = 0, \dots, r$  are continuous convex functions,  $F(\cdot, t)$  is a convex evolution mapping and  $Q$  is convex subset of  $\mathbb{R}^{2n}$ . Then for optimality of the arc

$\tilde{x}(\cdot)$  in the problem (PSL) it is sufficient that there exist Lagrange multipliers not all zero and an absolutely continuous function  $x^*(\cdot)$ , together with the first order derivative, satisfying a.e. the second order Euler-Lagrange inclusion

$$(a_1) B^* x^*(t) \in F^* \left[ x^*(t); (\tilde{x}(t), B\tilde{x}(t)), t \right] - \partial g(\tilde{x}(t), t); B\tilde{x}(t) \in F_A(\tilde{x}(t), x^*(t), t),$$

a.e.  $t \in [t_0, t_1]$ ,

the second order transversality condition:

$$(b_1) \left[ (s(t_1)x^*(t_1))' - q(t_1)x^*(t_1), -s(t_1)x^*(t_1) \right] \in \partial \varphi_0(\tilde{x}(t_1), \tilde{x}'(t_1))$$

$$+ \sum_{k=1}^r \lambda_k \partial \varphi_k(\tilde{x}(t_1), \tilde{x}'(t_1)) - K_Q^*(\tilde{x}(t_1), \tilde{x}'(t_1))$$

and the complementary slackness condition at  $t = t_1$ .

*Proof.* As in the proof of Theorem 3.1 the second order Euler-Lagrange inclusion (a<sub>1</sub>) of theorem implies that

$$H_F(x(t), x^*(t)) - g(x(t), t) - \left[ H_F(\tilde{x}(t), x^*(t)) - g(\tilde{x}(t), t) \right] \leq \langle B^* x^*(t), x(t) - \tilde{x}(t) \rangle,$$

whereas

$$\langle Bx(t) - B\tilde{x}(t), x^*(t) \rangle \leq \langle B^* x^*(t), x(t) - \tilde{x}(t) \rangle + g(x(t), t) - g(\tilde{x}(t), t).$$

Therefore, we have

$$\langle s(t)x''(t) + q(t)x'(t), x^*(t) \rangle - \langle s(t)\tilde{x}''(t) + q(t)\tilde{x}'(t), x^*(t) \rangle$$

$$\leq \left\langle (s(t)x^*(t))'' - (q(t)x^*(t))', x(t) - \tilde{x}(t) \right\rangle + g(x(t), t) - g(\tilde{x}(t), t).$$

By integration of this inequality over the interval  $[t_0, t_1]$  we obtain

$$\int_{t_0}^{t_1} \left[ \left\langle s(t)(x''(t) - \tilde{x}''(t)) + q(t)(x'(t) - \tilde{x}'(t)), x^*(t) \right\rangle - \left\langle (s(t)x^*(t))'' - (q(t)x^*(t))', x(t) - \tilde{x}(t) \right\rangle \right] dt \leq \int_{t_0}^{t_1} [g(x(t), t) - g(\tilde{x}(t), t)] dt. \quad (10)$$

Transforming the expression in the square parentheses in the left hand side of (10) as in the proof of Theorem 3.1 we have

$$\int_{t_0}^{t_1} [g(x(t), t) - g(\tilde{x}(t), t)] dt \geq \left\langle (x(t_1) - \tilde{x}(t_1))', s(t_1)x^*(t_1) \right\rangle - \left\langle (s(t_1)x^*(t_1))' - q(t_1)x^*(t_1), x(t_1) - \tilde{x}(t_1) \right\rangle \quad (11)$$

Now, by second order functional transversality inclusion we have

$$\begin{aligned} & \varphi_0(x(t_1), x'(t_1)) - \varphi_0(\tilde{x}(t_1), \tilde{x}'(t_1)) + \sum_{k=1}^r \lambda_k [\varphi_k(x(t_1), x'(t_1)) - \varphi_k(\tilde{x}(t_1), \tilde{x}'(t_1))] \\ & \geq \left\langle (s(t_1)x^*(t_1))' - q(t_1)x^*(t_1), x(t_1) - \tilde{x}(t_1) \right\rangle - \left\langle s(t_1)x^*(t_1), x'(t_1) - \tilde{x}'(t_1) \right\rangle \\ & + \left\langle x^*(t_1), x(t_1) - \tilde{x}(t_1) \right\rangle + \left\langle x^{*'}(t_1), x'(t_1) - \tilde{x}'(t_1) \right\rangle, (x^*(t_1), x^{*'}(t_1)) \in K_Q^*(\tilde{x}(t_1), \tilde{x}'(t_1)) \end{aligned}$$

Note that for all pair satisfying  $(x^*(t_1), x^{*'}(t_1)) \in K_Q^*(\tilde{x}(t_1), \tilde{x}'(t_1))$  it follows that  $(x(t_1), x'(t_1)) \in Q$ , i.e.,  $x(\cdot)$  is feasible and by virtue of the inequality

$$\sum_{k=1}^r \lambda_k \varphi_k(x(t_1), x'(t_1)) \leq 0 \text{ and by the complementary slackness condition}$$

$$\begin{aligned} \varphi_0(x(t_1), x'(t_1)) - \varphi_0(\tilde{x}(t_1), \tilde{x}'(t_1)) &\geq \left\langle (s(t_1)x^*(t_1))' - q(t_1)x^*(t_1), x(t_1) - \tilde{x}(t_1) \right\rangle \\ &- \left\langle s(t_1)x^*(t_1), x'(t_1) - \tilde{x}'(t_1) \right\rangle, \quad \forall (x(t_1), x'(t_1)) \in Q. \end{aligned} \quad (12)$$

Finally, summing the inequalities (11) and (12) we have the desired result

$$J[x(t)] \geq J[\tilde{x}(t)], \quad \forall x(t), t \in [t_0, t_1], \text{ i.e., } \tilde{x}(\cdot) \text{ is optimal. } \square$$

### References

1. D. Azzam-Laouir, S. Lounis and L. Thibault, “Existence solutions forsecond-order differential inclusions with nonconvex perturbations”, *J. Appl. Anal.* 86, 2011, pp. 1199–1210.
2. G. Bartuzel and A. Fryszkowski, “A topological property of the solution set to the Sturm-Liouville differential inclusions”, *Demonstratio Mathem.* 28, 1995, pp. 903–914.
3. Cernea, “On controllability for Sturm-Liouville type differential inclusions”, *Filomat* 27, 2013, pp.1321–1327.
4. S.J. Li, C. R. Chen and S.Y. Wu, “Conjugate Dual Problems in Constrained Set-Valued Optimization and Applications”, *Europ. J. Operat. Research*, 196, 2009, pp. 21–32.
5. P.D. Loewen and R.T. Rockafellar, “Optimal control of unbounded differential inclusions”, *SIAM J. Contr. Optim.* 32,1994, pp. 442–470.
6. E.N. Mahmudov, D.I. Mastaliyeva “Optimization of Neutral Functional-Differential Inclusions”, *J. Dyn. Control Syst.* 21, 2015, pp. 25–46.
7. E.N. Mahmudov, “Optimization of higher order differential inclusions with initial value problem”, *J.Appl. Anal.* 96, 2017, pp. 1215–1228.
8. E.N. Mahmudov, “Approximation and Optimization of Discrete and Differential Inclusions”, Elsevier: Waltham, USA; 2011, p. 396.
9. E.N. Mahmudov, “Mathematical programming and polyhedral optimization of second order discrete and differential inclusions”, *Pacific J. Optim.* 11, 2015, pp. 495–525.
10. E.N. Mahmudov, “Optimization of second order differential inclusions with Boundary value conditions”, *J. Nonlin. Convex Anal.* 18, 2017, pp. 1653–1664.
11. E.N. Mahmudov, “Optimization of Mayer Problem with Sturm-Liouville Type Differential Inclusions”, *J. Optim. Theory Appl.* 177, 2018, pp. 345–375.
12. B.S, Mordukhovich, “Optimal Control of Semilinear Unbounded Evolution Inclusions with Functional Constraints”, *J. Optim. Theory*

- Appl. 167, 2015, pp. 821–841.
13. B.S. Mordukhovich, “Variational Analysis and Generalized Differentiation, I: Basic Theory; II: Applications, Grundlehren Series (Fundamental Principles of Mathematical Sciences)”, Vol. 330 and 331, Springer, 2006.
  14. L.S. Pontryagin, V.G. Boltyanskii, R.V. Gamkrelidze and E.F. Mishchenko, “The mathematical theory of optimal processes”. John Wiley & Sons, Inc., New York, London, Sydney; 1965, p. 384.
  15. Yanping Chen, Yuelong Tang, “Select Numerical Methods for Constrained Elliptic Optimal Control Problems with Rapidly Oscillating Coefficients”, East Asian Journ. Appl. Mathem. 1, 2011, pp. 235–247.
  16. Q. Zhang and Gang Li, “Nonlinear boundary value problems for second order differential inclusions”, Inter. J. Nonlin. Sci. 9, 2010, pp. 84–103.
  17. J-C Zhou, J-S Chen and B.S. Mordukhovich, “Variational analysis of circular cone programs”, Optimization, 64, 2015, pp. 113–147.
  18. Zhenhai Liu, Xiuwen Li, “On The Exact Controllability of Impulsive Fractional Semilinear Functional Differential Inclusions”, Asian Journal of Control, 17, 2014, pp.1857-1865.
  19. Zheng Chen, Yan Gao, “Determining The Viable Unbounded Polyhedron Under Linear Control Systems”, Asian Journal of Control, 16, 2014, pp. 1561-1567.

## **EXPERIMENTAL RESEARCHES OF DYNAMICS OF WEIGHT OF TRIAL MASSES AND GRAVITATIONAL QUANTUM EFFECTS**

**E.N. Khalilov**

*Scientific and Research Institute of Forecasting and Studying the Earthquakes of the International Academy of Science H & E, Baku, Azerbaijan  
e-mail: prof.khalilov@ias-as.org*

### **Annotation**

In this research paper there are given the results of studies on the possibility of recording gravitational quantum effects using two types of independent experiments.

In the first experiment, deviations of experimental measurements of  $\Delta g$  variations from the theoretically calculated  $\Delta g$  values were recorded under the influence of changes in water mass in two tanks of 25 tons each, located above and below high-precision quartz gravimeters. Analysis of the difference between the actually recorded and

theoretical values of gravity allowed the author to propose his own model for explaining the results obtained. According to this model, the recorded deviations can be explained by the influence of gravitational quantum effects, in particular, such as the presence of gravitational permeability, gravitational absorption and volume gravitational reflection of the medium. In the second experiment, the author experimentally established for the first time the change in weight of a trial non-spherical mass with a large ratio of length to thickness, depending on its spatial orientation and while maintaining the center of mass unchanged.

The author concluded that non-spherical masses with a large ratio of length to thickness play the role of antennas of gravitational quantum radiation. The rotation of such masses relative to their center, while maintaining the location of the center of mass unchanged, according to Newton's theory of gravity and the General Theory of Relativity, should not affect their weight if the sizes of the trial masses are negligible compared to the mass of the gravitating body. Meanwhile, experiments have shown that changing the weight of trial masses of non-spherical shape with a large ratio of length to thickness depends on their angle of rotation, relative to the center point. This is also confirmed by spectral analysis. The weight of the trial mass was measured with an accuracy of  $10^{-4}$ gr and deviations were recorded at a level of  $10^{-3}$ gr. In addition, the experiments allowed to establish that, depending on the spatial orientation of the trial mass, the amplitude of the recorded gravitational pulses (pulses of change of the weight) varies, which can be explained by the presence of the radiation pattern of the trial mass when registering gravitational pulses. The author made the assumption that the source, registered experimentally, powerful gravitational impulses, may have a cosmic nature. In both cases, more than 100 experiments were conducted for each type of research, which statistically confirmed the results obtained.

## **1. Evolution of views on nature of gravitation**

I. Kepler showed how planets move, but why do they move like this? What driving force holds them in elliptical orbits around the Sun and makes it increase and then decrease the speed, as it follows from Kepler's second law? In the middle of the XVII century. three prominent scientists worked in England: versatile scientist and experimenter Robert Hooke (1635-1703), architect, mathematician and astronomer Christopher Rehn (1632-1723), and astronomer and physicist Edmund Halley (1656-1742); the latter served as a royal astronomer and is known for his research on comets. E. Galley concluded that the force of attraction varies inversely with the square of the distance. However, Halley and his colleagues could not prove mathematically that the law of attraction implies the conclusion about the movement of the planets in elliptical

orbits. In the same year, Halley went to Cambridge for advice to I. Newton. To Halley's question of which trajectory the planet should move under a force inversely proportional to the square of the distance from the Sun, Newton immediately replied that this trajectory is an ellipse. He proved it mathematically. Newton published his results in the three-volume book "Mathematical Principles of Natural Philosophy", published in 1687. In the book, Newton showed that a body can move along a curve of a conic section (circle, ellipse, parabola and hyperbole) only if it is influenced by a force inversely proportional to the square of the distance and directed to a fixed point.

One of the postulates of Newton's natural philosophy was to recognize the absolute world time. Newton wrote in his book: "The absolute partial mathematical time, in itself and in its essence, without any relation to anything external, flows evenly and is otherwise called duration" (Nicholson, 1983). Therefore, the reference system can be considered as a strictly defined method of measuring position and time. An inertial system is a reference system in which the bodies, in the absence of external influences, move uniformly and rectilinearly. According to Newton, the inertial reference system must be at rest or in uniform motion with respect to the "absolute space". Newton wrote: "Absolute space, by its very essence, irrespective of anything external, remains always the same and motionless." According to him, "absolute space" has the property only to influence bodies (to resist their acceleration), but the matter cannot act on the space itself. In 1872, Ernst Mach hypothesized that the inertia property has nothing to do with "absolute space", but arises as a result of some kind of interaction of each individual body with all other masses in the Universe at once. If there were no other masses in the world, Mach said, then an isolated body would not have inertia. This idea contradicts Newton's view that the body would in this case also possess inertia, as a result of the action of absolute space. Einstein called Mach's hypothesis the Mach's principle. In 1905, Einstein – at that time a modest employee of the Swiss Patent Office in Bern - published a paper on the special theory of relativity and finally destroyed the shaky foundations of the classical concepts of space and time. One of the central provisions of the private theory of relativity says: "nothing can move in space faster than light". There is an assumption that there are possible particles with finite values of mass and energy that move with a speed that always exceeds the speed of light, and as their speed decreases, i.e. approaching it to the "light barrier", their mass should increase indefinitely. These putative particles are called tachyons. Their existence remains the subject of scientific controversy (Nicholson, 1983). According to the special theory of relativity, no information can be transmitted faster than the speed of light. If it were possible to transmit information faster than the speed of light, we would learn about events that have not yet occurred and could have prevented them. This would violate the fundamental principle of physics: causation. The particular theory of relativity

undermined the two main foundations of Newton's theory: "space and time have ceased to be absolute". It turned out that observers moving relative to each other at a constant speed close to the speed of light should receive different results when measuring time and length. At the Tbilisi conference in 1965, Rukman and Yuhvidin proposed an interesting project to test the special relativistic time lag. It was proposed to compare the readings of two atomic clocks, which at the initial moment were matched in frequency and phase of oscillations, and then one clock should be placed on a moving artificial Earth satellite. When the satellite is moving at a speed of 8 km / s, it takes about 3 days to obtain an effect that is significantly higher than the error. In this case, the lag will be 97 microseconds, while the error can be reduced to 1 microsecond (V.B.Braginsky, UFN., 86, 1965, 433). In 1916, A.Einstein published his general theory of relativity. We will not stop on this widely known theory, just to remind that the general theory of relativity has combined the principle of equivalence and the idea of the curvature of space - time by massive bodies. The general theory of relativity has fundamentally changed our understanding of space, time, and aggression. It ceased to be a force acting at a distance, as in Newton's theory, but turned out to be closely connected with the geometry of space and time. It turned out that the bodies are not directly affected by gravitational forces and their movement is a response to the curvature of space - time. Any change in the gravitational field of a body is not transmitted instantly to any point in space, but propagates at the speed of light. It is considered that G (gravitational constant) always has the same value, i.e. unchanging and absolute. However, there are hypotheses about the possibility of changing the value of G in time. The first to question the immutability of the gravitational constant G, was Dirac from the University of Cambridge. In 1937, he expressed the "hypothesis of large numbers," according to which there are certain relationships between key physical quantities. For example, the force of electrostatic repulsion between two electrons refers to the force of their gravitational attraction, like  $10^{40}: 1$ . The ratio of the age of the Universe, estimated in the interval  $10^{17}-10^{18}$  to the time it takes the light to pass an electron in diameter, is also  $10^{40}: 1$  (Dirac PAM Cosmological Constants. In book "Albert Einstein, and the theory of gravity". M ., World, 1979).

## **2. About the quantum nature of gravitation**

The general theory of relativity treats the gravitational interaction of the masses as a property of the masses to change the curvature of the space-time continuum [1]. The basis of GTR is a theoretically and experimentally proven fact of the equality of the inertial mass and the gravitational mass for any body, leading to the equivalence principle [2]. Meanwhile, the quantum theory of gravity is based on a completely

different representation of the physical nature of gravity. The basis of the quantum theory of gravity, is the concept of the existence of gravitational quanta. The founders of quantum mechanics - Paul Dirac and Erwin Schrödinger, who formulated the foundations of quantum mechanics in 1925, laid the foundations of the quantum theory of gravity [3]. M. Planck in 1900 put forward the hypothesis that energy is emitted and absorbed not continuously, but in separate quanta. The energy of each quantum is:  $\varepsilon = \hbar\nu$ , where  $\hbar$  is Planck's constant,  $\nu$  is frequency. Based on the Planck's hypothesis, the rest mass of the photon is zero. The quantum of electromagnetic radiation exists only, propagating at the speed of light [4]. In 1925, American scientists George Eugene Uhlenbeck and Samuel Abraham Goudsmit introduced the concept of spin into physics based on the analysis of spectroscopic data [5]. So, they suggested that an electron can be considered as a "spinning top" with its own mechanical moment  $\hbar/2$ , where  $\hbar$  is Planck's constant. Thus, a "spin" is its own angular momentum of an elementary particle, having a quantum nature and not associated with the movement of particles as a whole. Spin is measured in units of the Planck's constant  $\hbar$  and is equal to  $J\hbar$ , where  $J$  is an integer or half-integer number characteristic of each type of particle, called the spin quantum number. For example, the spin of an electron, proton, neutron, neutrino, as well as their antiparticles, is  $1/2$ . The photon spin is equal to one. In the work *The Unified Theory of Gravity and Electricity*, an attempt was made to create a unified field theory for electromagnetic and gravitational interactions [6]. We would like to note in details the unity and differences of electromagnetic and gravitational interactions when trying to create a unified field theory. The qualitative difference between electromagnetic and gravitational interactions is that electrodynamics contains two electric charges (electrons and protons) and the ratio of electric charge to mass can be different even when the bodies are charged equally (the difference may be in excess or lack of electrons), and in gravity, all charges (gravitational masses) have the same sign (attraction) and the same ratio of gravitational charges to inert masses. The last statement is the principle of equivalence of the general theory of relativity (GTR) [7]. In the private theory of relativity the equivalence of mass and energy is established, and in quantum mechanics the concept of energy discreteness and the uncertainty principle. In modern quantum field theories, forces are considered as the result of the exchange of certain exchange particles between interacting particles. Exchange particles are called "virtual", since they cannot be observed and their existence is too short. For example, in an electromagnetic interaction, if two electrons approach each other, then they exchange a particle - a photon, as a result of which they are repelled. Processes of this kind are beautifully described using Feynman diagrams [8]. One of the founders of the quantum theory of gravity is considered Paul Dirac, who published the first works in this field in 1928. In 1935, the Soviet physicist M.P. Bronstein introduced the concept of quanta of



a gravitational field - gravitons. It is assumed that gravitational radiation is transmitted over long distances by gravitons [9]. It is believed that graviton has a spin equal to 2, since all interactions with the exchange of particles having a spin equal to 2 are characterized only by attraction.

According to GTR the gravitational radiation can be transported over long distances by gravitational waves. Gravitational waves are radiated at non-uniform movement of masses and were first theoretically substantiated by A. Einstein [10].

In 2016 in the journal *Phys. Rev. Lett.* there were published for the first time the results of the registration of gravitational waves by their direct detection on September 14, 2015 using the LIGO and VIRGO gravitational wave detectors (*B. P. Abbott et al. Binary Black Hole Merger Binary Black Hole Merger*) *Phys. Rev. Lett.* 116, 061102 - Published 11 February 2016). These research results confirmed the theoretical justification of gravitational waves, given in the works of Albert Einstein. Meanwhile, to test the quantum theory of gravity, with which Albert Einstein did not agree, and a deeper and objective understanding of the physical essence of gravity, it is necessary to experimentally register gravitational quantum effects. In the quantum theory of gravity, the energy of gravity is transported over long distances by means of gravitational waves having a wave-particle basis, similarly to electromagnetic waves.

This predetermines the propagation of all laws of the wave-particle theory applied to electromagnetic waves and to gravitational waves. Therefore, along with such effects as interference, diffraction, refraction, polarization, in relation to gravitational waves, such effects as gravitational reflection and shielding, absorption, gravitational permeability of the medium, etc. should also be valid. There is known a method of registering the gravitational waves with the help of the detector Webber [11]. For the first time an attempt to detect gravitational waves was made by J. Weber of the University of Maryland. J. Weber designed a gravitational wave detector. The detector was a solid aluminum cylinder about 1.5 m long and weighing several tons. Sensitive sensors were installed on the cylinder, recording the deformation stresses occurring in the metal. The gravitational wave is a variable gravitational field, which freely propagates in space with the speed of light and manifests itself in the appearance of relative accelerations of bodies. Spreading in space, the gravitational wave bends quadrupole space and all the bodies in it. Thus, according to the plan of J. Weber, gravitational waves were supposed to deform the aluminum cylinder quadrupolarly. These deformations were to be registered with strain gauges mounted on its surface. The disadvantage of this method is that it contradicts the principle of relativity of the special theory of relativity STR, which states that all laws are invariant with respect to the transition from one inertial reference system to another. This means that if in some way the coordinate system changes, then all processes and laws of nature in this coordinate

system change invariantly with respect to each other. I.e. along with the measured value (linear dimensions of the cylinder), the dimensions and shape of the measuring sensors change proportionally, as a result of which, the sensors cannot register the deformation of the cylinder associated with the passage of a gravitational wave. At the same time, these sensors record any vibrations and noises that are not related to gravitational waves, such as microseisms, vibrations from working mechanisms, etc. [12].

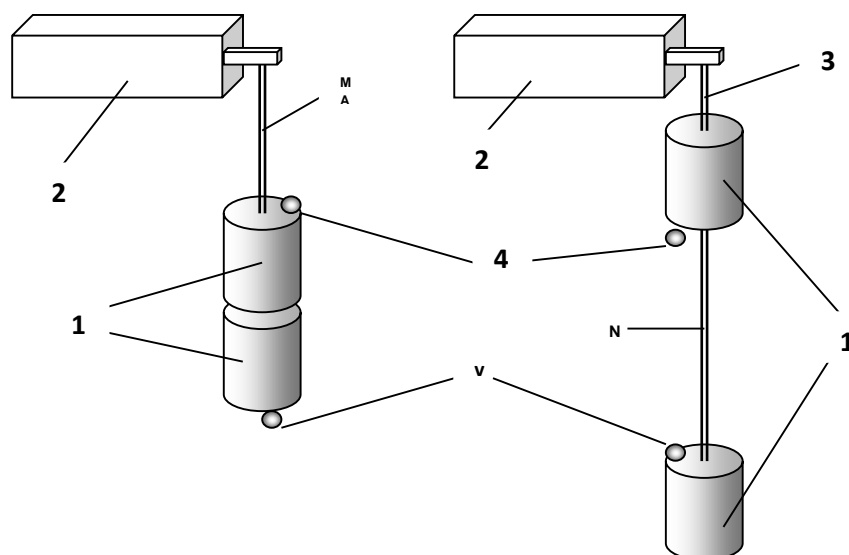
### **3. Experimental researches of gravitational quantum effects**

#### **3.1. The method of registration of gravitational quantum effects and device for its implementation**

*(E.N.Khalilov Method for recording the gravity of quantum effects and device for carrying out said method. PCT. WO 2005/054901, 16/06/2005, Geneva.)*

In the quantum theory of gravity, it is considered that the gravitational force acting between two particles of matter is carried by a particle with spin 2, which is called a graviton. Graviton does not have its own mass, and therefore the power transferred by it is long-range. The gravitational interaction between the Sun and the Earth is explained by the fact that the particles that make up the Earth and the Sun exchange gravitons. The effect they create is expressed in the rotation of the earth around the sun. To test the quantum theory of gravity and a deeper and objective understanding of the physical essence of gravity, it is necessary to register gravitational quantum effects. From the literature there are known the attempts of registering the gravitational quantum effects, in particular, the effect of gravity shielding, including measuring the weight of the trial mass over a high-speed superconducting ceramic disk rotating at high speed, in an alternating magnetic field (*Science and Life, No. 1, 1999*). This effect was observed by E. Podkletnov, but was not officially confirmed and perceived by world science. The most interesting, in our opinion, is the method of recording the force of gravitational interaction of masses (gravitational constant  $G$ ).

This method could, with certain additions, be used to register gravitational quantum effects and its authors were a step away from this, but, unfortunately, did not take advantage of the excellent opportunity. The essence of measuring  $G$  using the above method is that the weight of the trial mass is measured directly on the surfaces - on top and bottom of two tanks 1 filled with mercury weighing 13 tons and playing the role of large gravitating masses placed coaxially one above the other, Fig.1. (*Nolting F., Schurr J., Schlamminger St., and Kündig W. Determination of the gravitational constant of the balance sheet. Physics Institute, University of Zurich, Zurich, Switzerland. Europhysics News (2000) Vol. 31 No 4*) [21].



**Fig.1. Schematic view of the installation for measuring the gravitational constant G (Nolting F., Schurr J., Schlamminger St., and Kündig W. 2000)**

When this capacity is hung on a special support 2 using flexible cables 3 and have the opportunity to approach and move away from each other, Fig. 1. Measuring the difference in weight of trial masses 4, depending on their location on the surface - above or below the tanks, determine the force of mutual attraction of the masses - the gravitational constant G. Meanwhile, this technical solution is not intended for registration of gravitational quantum effects, since the trial masses move together with the gravitating masses (tanks with mercury). In addition, gravitating masses are constant, whereas, for the registration of quantum effects, it is necessary to use variable masses. Meanwhile, the quantum theory of gravity implies the existence of quantum effects based on the principles of quantum mechanics. So, when considering the propagation of electromagnetic waves, from the point of view of wave-particle theory, such quantum effects as reflection, refraction, absorption, etc. are well studied and described. Similar effects should manifest themselves in gravity if the quantum theory of gravity is indeed valid. For the purpose of experimental verification of this concept, under the supervision of the author, a special installation “G-QUANTUM” was created, the design of which, also developed by the author back in 1988, is described in [3]. The facility has been created at the Scientific Research Institute of Forecasting the

Earthquakes. The “G-QUANTUM” installation consists of two cylindrical tanks with a volume of 25 m<sup>3</sup> each, vertically mounted one above the other, as shown in Fig.2. The lower reservoir is vertically mounted on the surface of the earth. The upper tank is coaxially located above the lower one at a distance of about 2.5 meters, which allows the researcher to make measurements between the two tanks of relative values of gravity using two quartz gravimeters such as KS-5 and KS-8 simultaneously. With the help of the third quartz gravimeter KV2, temporary variations of gravity were monitored in a special room remote from the installation at a distance of about 70 meters. At the same time, calculations show that the lateral gravitational influence of the installation on the readings of the third gravimeter at such a distance can be neglected. In Fig.2. a photograph of the “G-QUANTUM” installation is shown at a special test site of the SRI of forecasting and forecasting the earthquakes.

Near the installation there is a digital broadband seismic station that continuously records all seismic processes and noise. When conducting research, possible effects of seismic processes on gravimeter readings are taken into account.

As can be seen in the photograph (Fig. 2.), a special room of the measuring laboratory has been made between the upper and lower tanks, in which all measurements of the relative values of gravity and their primary interpretation are carried out. The room temperature is kept constant at the time of the experiment. In this room, the installation is also managed - filling the tanks with water and emptying them, as well as monitoring the exact position of the water level (with an accuracy of 0.5 cm). To control the water level in the tanks, a special float system is used. At a distance of about 100 meters from the installation, the water receivers are installed (Fig. 3.), from which the installation tanks are filled and into which water is pumped when the tanks are empty. Water is pumped into the installation tanks and their rapid emptying is carried out with the help of powerful electric pumps.

The essence of the proposed method is the registration of various gravitational quantum effects, namely, gravitational screening, reflection and absorption. For this purpose, on the surface of the Earth 1 Fig.4. two identical tanks 2 and 3 are installed coaxially one above the other, into which a liquid of known density is filled. Between tanks 2 and 3 there is a space in the center of which a measuring device (gravimeter) is installed containing a trial mass, the deviation of which, under the influence of varying gravity, is recorded by the sensitive system of the device.

When the sensitive mass (gravimeter) is located in the center between two tanks with liquid 2 and 3 in Fig. 5, the force of attraction  $F_2$  to the trial mass 4 from the side of the mass of the lower tank 2 filled with liquid and the force  $F_3$  from the side of the same upper tank 3 filled with liquid compensate each other. Thus, according to the law of universal perception and the theory of gravity based on the general theory of relativity

(GTR), with empty and completely filled tanks, only the force of gravity of the Earth  $F_1$  will act on mass 4. There are measured the relative values of gravity between two coaxially arranged one above the other, the same tanks, into which a liquid of known density can be filled, Fig.5. After each change in the mass of the fluid in the tanks, the values of the gravity anomalies are theoretically calculated and compared with actual values of  $\Delta g_\phi$ .

Based on the obtained difference between the theoretical and actual values of the gravity anomalies, the registration of gravitational quantum effects is viewed. At a distance  $R$ , providing the necessary reduction of the gravitational effect on the gravity meter 4 there is placed a receiver for liquid 5, the volume of which is not less than the total volume of tanks 2 and 3. A pump 6 (pumping liquid from the tanks to the reservoirs) is connected to the receiver and the pump 7 is connected to reservoirs, pumping from the reservoirs to receiver, and each reservoir 2 and 3 independently connected to the receiver 5 with pipeline 8 for pumping the liquid. On each reservoir 2 and 3 there are installed the liquid level indicators 9, and gate valves 10 are installed on the incoming and outgoing pipelines to the reservoirs. Air valves 11 are installed on the surface of each reservoir 2 and 3 and receiver 5.

The device works as follows. Measurement of gravity is performed using a meter 4 between empty reservoirs 2 and 3. Then, using a pump 6 from receiver 5 to reservoirs 2 and 3, water is pumped through pipelines 8, while valves 10 are set to - open.

The water level in the reservoirs is measured using liquid level indicators 9. After the reservoirs are filled to the required level, the valves 10 overlap and the transfer pump 6 is turned off. If it is necessary to decrease the water level in reservoirs 2 and 3, the valve 10 of the required tank is turned to the open position and the pump is turned on 7, pumping water from the reservoir to the receiver 5.



**Fig.2. Photo of the installation “G-QUANTUM” at the polygon of the Scientific Research Institute of Forecasting the Earthquakes.**



Fig.3. Water receivers

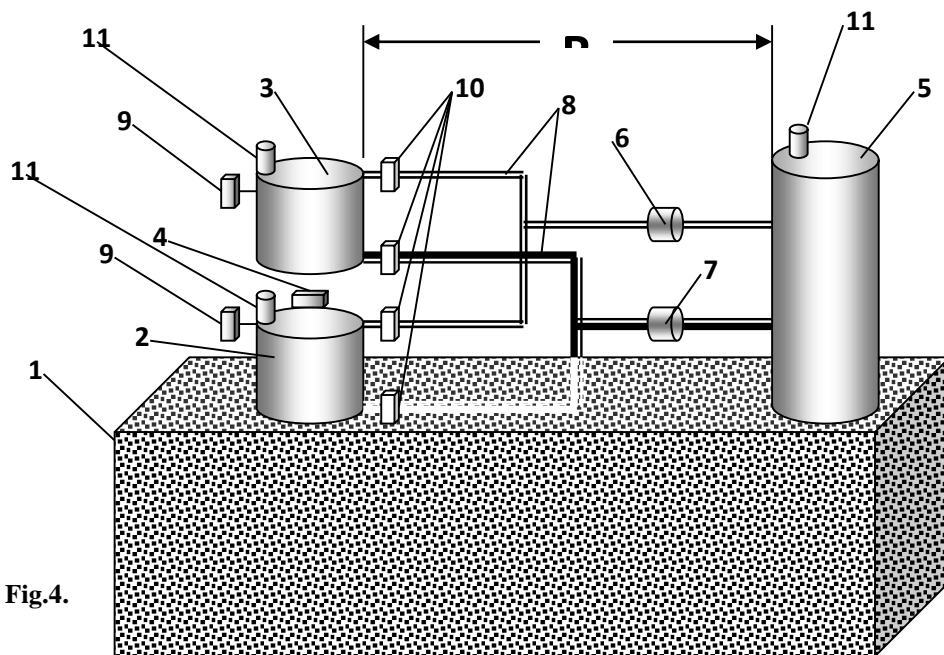


Fig.4.

Installation for the study of quantum effects in the gravitational interaction of the masses "G-QUANTUM" / 3 /.

When pumping water from the receiver and reservoirs or from reservoir to the receiver, the air valves 11 on the surfaces of the reservoirs and the receiver connect the internal cavity of the reservoirs and the receiver with the atmosphere and facilitate the release of air displaced by the liquid into the atmosphere or, conversely, the inflow of additional air when the liquid decreases. Let's consider the scheme of distribution of forces acting on the gravimeter sensitive mass, Fig.7. The following forces act on the sensitive mass of the gravimeter: The force of gravity of the Earth 1 –  $F_1$ , the force of attraction of the water of the lower reservoir 2 –  $F_2$  and the force of gravity of the water of the upper reservoir 3 –  $F_3$ . We consider in this case only the forces associated with gravity. Based on the theory of relativity, the attraction of the masses is the property of the masses to change the curvature of space. Consequently, gravity, measured exactly in the center between reservoir with empty reservoirs and with full reservoirs, must have the same value, since in this case the force  $F_2$  is balanced by the force  $F_3$ . Any deviation from this result (with the exception of deviations as a result of instrument errors or measurement methods) will indicate the presence of unrecorded forces, i.e. about quantum effects. At the same time, the forces that should manifest themselves in quantum gravity and characterize the reflection of the gravitational radiation of the Earth by water in the upper and lower reservoirs are designated by us, respectively  $F_4$  and  $F_5$ .

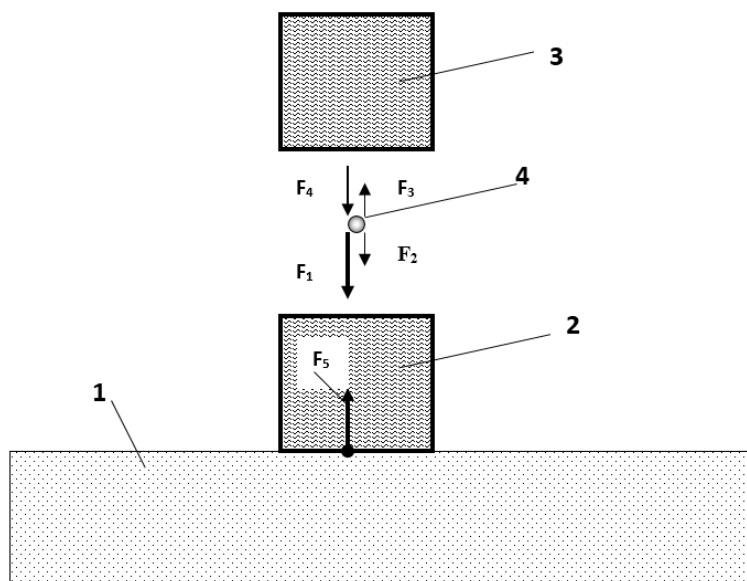
### **3. 2. Method of experiments**

To simplify further consideration of the interaction of various gravitational forces affecting mass 4, the decrease in force  $F_1$  as a result of the reflection of water in the lower reservoir 2 of the part radiated in the form of gravitational energy quanta of the Earth is shown as an upward force  $F_5$ , that is, an oppositely directed force  $F_1$ .

The quartz gravimeters GNU-KS5, GNU-KS8 and GNU-KV (produced by the USSR) were rigidly mounted on a measuring pedestal located in the G-QUANTUM facility, so that the sensitive masses of both gravimeters were exactly halfway between the central points of the upper plane of the lower reservoir and lower plane of the upper reservoir.

The relative gravity values between the two reservoirs were measured using three gravimeters simultaneously. To account for the drift of the zero point of gravimeters, each measurement was performed as follows. At first,  $\Delta g$  was measured by three gravimeters simultaneously at the measurement starting point, located at a distance of 70 meters from the G-QUANTUM installation, in order to eliminate the gravitational effect of the installation itself on the readings of gravimeters.





**Fig.5. The distribution of various forces affecting on mass 4.**

Then, gravimeters were installed directly on the pedestal of the installation and the main measurement was made, after which, it was again measured at the starting point. Thus, the measurements were carried out by “short flights”: the starting point - the main metering point (setting G-QUANTUM) - the starting point. The duration of the flight was no more than 30 minutes. This made it possible to minimize the influence of gravimeter zero-point drift. Thanks to this work system, every short flight was independent. Practice has shown that this approach was the most optimal, since in this case, the deviations of the readings of gravimeters from each other were minimal. 100 experiments were carried out. The flaw was 8%, the root-mean-square error (accuracy) was  $\pm 0.03$  mGal. In each variant, according to the results of the experiments, graphs were constructed for each experiment separately, which were carefully analyzed. After that, on the basis of all the experiments, an averaged graph was constructed, which with a high degree of confidence characterized the patterns of change of  $\Delta g$  for each variant. Below are the results of the averaged values for each option separately. Measurements of relative gravity values were made on the basis of the following options for filling reservoirs with water:

**Variant 1.**

- Both containers are empty;
- The bottom one is half full, the top one is empty;
- The bottom one is full, the top one is empty;
- The bottom is completely filled, the top half;
- The bottom and top are completely filled;

**Variant 2.**

- Both containers are full;
- The top one is full, the bottom one is half empty;
- The top one is full, the bottom one is completely empty;
- Upper half empty, lower empty;
- Top and bottom are empty;

**Variant 3.**

- Both containers are empty;
- The top one is half full, the bottom one is empty;
- The top one is full, the bottom one is empty;
- The top one is filled completely, the bottom one is half full;
- Top and bottom are filled completely;

**Variant 4.**

- Both containers are full;
- Upper half emptied, lower full;
- The upper one is completely emptied - the lower one is full;
- The top is empty, the bottom is half empty;
- Top and bottom are devastated.

During the experiment, for the analysis and interpretation of its result, the magnitude of the relative value of gravity itself did not have a fundamental value. More important was the deviation of the value and the sign of this magnitude with different ways of filling containers with water. It must be borne in mind that in calculating the final results, the gravitational influence of the Lunno-Solar tides was taken into account.

**Variant 1.**

In Fig.6. the variant 1 of registration of gravitational quantum effects is shown by means of the proposed technical solution. As it can be seen in graph 1, the first measurement of the relative values of gravity was carried out between two empty reservoirs. In this case, only the gravitational force of the Earth  $F_1$  acts on the sensitive gravimeter mass. When measuring 2 the lower reservoir is half filled with water, while,

as it can be seen from graph 1, the actual measurement results showed an increase in gravity, almost coinciding with the theoretically calculated values. This means that a force directed towards the Earth and equal to the sensitive gravimeter mass:

$$F = F_1 + F_2 \quad (1.1)$$

In the third dimension, the lower reservoir is completely filled with water, however, the gravity value instead of further increasing drops to a minimum, while the theoretically calculated curve shows that the  $\Delta g_\phi$  value should become maximum due to the maximum increase in the  $F_2$  gravity force by reservoir 2, Fig.5.

Consequently, there is an unrecorded effect leading to a decrease in  $\Delta g_\phi$ . According to the author, this effect can be a partial reflection of the gravitational energy of the Earth towards the Earth by the mass of a reservoir with water 2 (Fig. 5), while the reflected part of the gravitational energy is designated by us  $F_5$ .

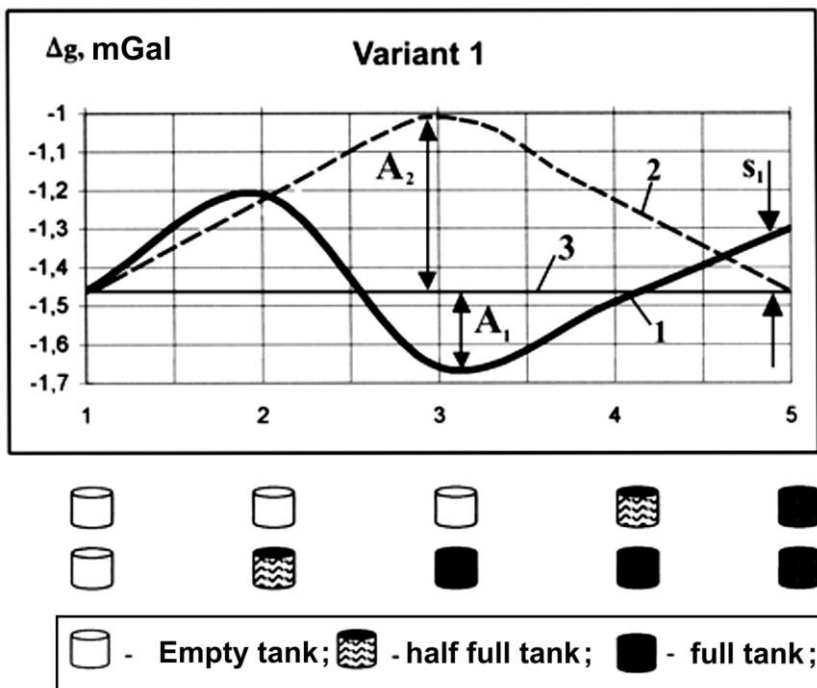


Fig.6. The scheme of the experiment for variant 1.

At the same time, the graphs show that the theoretically calculated amplitude  $A_2$  of an increase in gravity due to the influence of the mass of water in the lower reservoir is almost twice as high as the amplitude  $A_1$  of the actually measured decrease in  $\Delta g_\phi$ .

This can be explained as follows. When filling reservoir 2 only half, the force of attraction  $F_2$  of the mass of water acting on the gravimeter was higher than the force of gravity  $F_5$  reflected by this mass. However, due to the advancement of the increase in the reflected gravitational force  $F_5$  (reducing gravity) compared with the increase in the force of attraction of the increasing mass of water in reservoir 2, with a further increase in the mass of water, the force  $F_5$  began to exceed the force  $F_2$ , i.e.  $F_5 > F_2$ . Thus, at the third measurement, the force acting on the sensitive mass became equal to:

$$F = F_1 + (F_2 - F_5) \quad (1.2)$$

In the fourth measurement, the second reservoir 3 is half filled with water, which should cause gravity 4 sensitive mass towards reservoir 3 with a force  $F_3$  and show a corresponding decrease in  $\Delta g_i$ , as shown in the theoretically calculated graph 1 Fig.9. However, in fact,  $\Delta g_f$  increases. This is explained as follows. As in the case of filling reservoir 2, when filling reservoir 3 half, the sensitive mass 4 is acted upon by the force  $F_3$  of the water mass of reservoir 3 and the force  $F_4$  of the reflected gravitational energy of earthly gravity caused by the partial reflection of gravitational quanta emitted by the Earth. From here follows  $F_4 > F_3$ .

Thus, the following force  $F$  acts on the sensitive mass 4:

$$F = F_1 + (F_2 - F_5) + (F_4 - F_3) \quad (1.3)$$

The last fifth measurement is carried out with reservoirs 2 and 3 completely filled with water, Fig .6. The actual value of  $\Delta g_\phi$  increases, which is explained by the increase in the force  $F_4$  in comparison with the increase in the force of attraction  $F_3$  of the mass of water in reservoir 3. For this case, the expression is legitimate (3).

Since measurement 5 is done when both reservoirs are completely filled, the theoretical value of the relative value of gravity  $\Delta g_i$  in this case is equal to the theoretical value of  $\Delta g_t$  with empty reservoirs. However, this is not observed and the actual value of  $\Delta g_\phi$  with both filled tanks is higher than  $\Delta g_f$  with both empty reservoirs by the value of  $S_1$  (Fig. 6), equal to:

$$S_1 = \Delta g_\phi - \Delta g_m \quad (1.4)$$

### **Variant 2.**

In example 2, the first measurement is performed when both reservoirs 2 and 3 are fully filled, Fig.7. Then a second  $\Delta g_\phi$  is measured with the bottom reservoir emptied by half. As you can see in the graph, Fig. 7, the value of  $\Delta g_\phi$  decreases slightly, but less

than it should have been, which indicates a decrease in the influence of the  $F_2$  force due to a decrease in the mass of water in the reservoir 2. That is,  $F_2 = F_5$  (the force of attraction the water in reservoir 2 almost balances the force caused by the partial reflection of water by gravitational quanta emitted by the Earth). Thus, the force  $F$  acts on the sensitive mass:

$$F = F_1 + (F_4 - F_3) \quad (1.5)$$

The third measurement is performed with a completely emptied lower reservoir 2 and a full upper reservoir 3, Fig. 7. As it can be seen in graph 1 Fig.7 the actual value of  $\Delta g_\phi$  reaches a maximum, whereas the theoretically calculated  $\Delta g_t$  is at a minimum (graph 2). This is explained as follows. The force of attraction  $F_2$  of a completely empty reservoir 2 is zero, as well as the force  $F_5$  of reflected energy of gravity by water in reservoir 2. However, since the force  $F_5$  resulting from the partial reflection (screening) of gravitational quanta radiated by the Earth, significantly exceeds the force of gravity of water itself reservoir 2, the actual measurement shows an increase in  $\Delta g_\phi$ . That is, that part of the energy of gravitational quanta, which did not affect the sensitive mass 4 due to the effect of its partial shielding by the mass of water in the reservoir 2, after emptying the water, began to pass freely and affect the sensitive mass of the gravimeter 4, causing an increase in its force to Earth.

At the same time, the force of reflected energy of gravity  $F_4$  significantly exceeds the force of attraction  $F_3$  of the mass of water in the filled reservoir 3. Therefore, the force  $F$  acts on the sensitive mass of the gravimeter:

$$F = F_1 + (F_4 - F_3) \quad (1.6)$$

At the same time in Fig.7. it can be seen that on the theoretically calculated graph 2, the amplitude  $A_2$  of the minimum value  $\Delta g_t$  is almost twice as high as the amplitude of the maximum value  $g_f$  on the actual graph 1. This indicates that two mutually opposite forces play a role in increasing  $\Delta g_f$  when the lower reservoir 2 is empty acting on the sensitive mass 4 of the gravimeter - the force of gravitational attraction  $F_3$  of the mass of water in the upper reservoir 3 and, much higher than the first, the force  $F_4$  of the reflected mass of water (screened) energy emnogo attraction caused by partial reflection of gravity quantum emitted by Earth, water in reservoir 3.

The fourth measurement, which is performed with the upper reservoir 3 emptied by half, shows the actual reduction of  $\Delta g_\phi$ , instead of the theoretically calculated increase. Naturally, a decrease in the mass of water in reservoir 3, in accordance with the law of universal attraction and Einstein's theory of gravity, would have led to an

increase in  $\Delta g_f$ , since the force of attraction of this mass would have to partially compensate for the force of gravity.

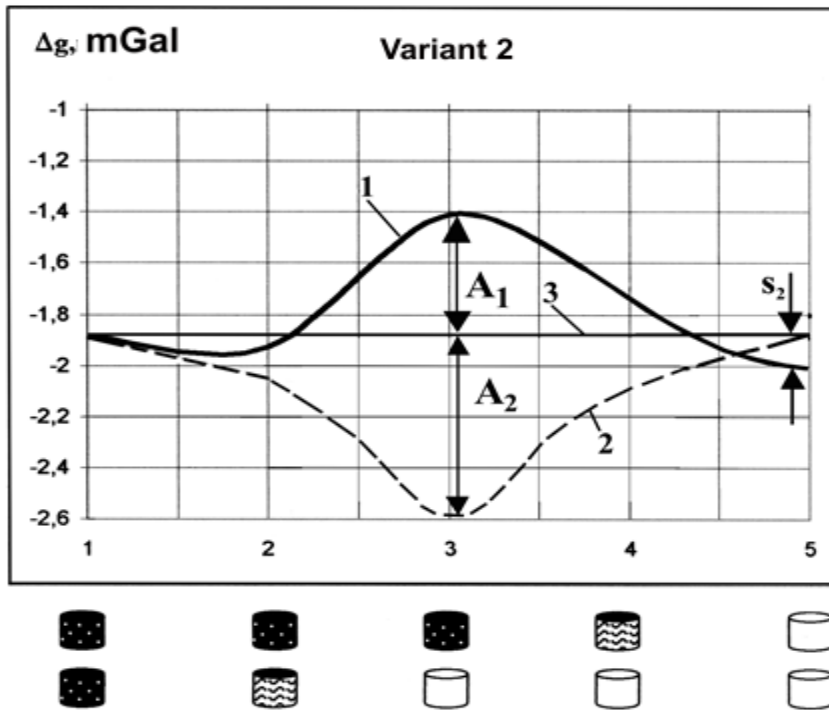


Fig.7. The scheme of the experiment for variant 2.

Meanwhile, in practice, the opposite happens. This indicates that the force  $F_4$  of the shielded gravitational energy of the Earth acting on the sensitive mass 4 decreases, outpacing the decrease in the force of attraction  $F_3$ . Those in the fourth measurement, the resultant force  $F$  acting on the sensitive mass of the gravimeter also corresponds to expression (1.6). Measurement 5 is performed when both reservoirs are completely emptied and shows a further actual reduction of  $\Delta g_\phi$ , while the theoretical value of  $\Delta g_t$  with empty tanks is equal to the theoretical value of  $\Delta g_t$  with completely filled both tanks. This is due to the fact that the forces of gravity of the water of both filled reservoirs acting on the gravimeter must be mutually compensated. However, the actual values indicate that the value of  $\Delta g_f$  with empty tanks is lower than  $\Delta g_\phi$  when filled by  $S_2$ :

$$S_2 = \Delta g_\phi - \Delta g_t \quad (1.7)$$

This only indicates the presence of the gravitational reflection coefficient. Consider the interaction of forces acting on the sensitive mass 4. Earth's force of gravity  $F_1$ , mutually compensating each other force of attraction  $F_2$  and  $F_3$  with water masses in reservoirs 2 and 3, force  $F_4$  caused by the reflection of water mass in reservoir 3 increasing the force of gravity and balancing it  $F_5$  the result of the reflection of the gravitational energy of the Earth and reducing the effect of the force of attraction of the Earth on the sensitive gravimeter mass. Thus, the total force  $F$  is equal to the sensitive mass 4 of the gravimeter:

$$F = F_1 + (F_3 - F_2) + (F_4 - F_5) \quad (1.8)$$

In this case,  $F_3 = F_2$ , so their difference = 0.

Therefore,  $F_4 - F_5$  is not zero, and  $F_4 > F_5$ , i.e.  $F_4 - F_5 = \Delta F$ .

To explain the physical essence of the formation of the force  $\Delta F$ , we consider the scheme in Fig.7. As it can be seen in the figure, the conditions for the reflection of the gravitational energy of the Earth when reflected by a reservoir of water 2 and reservoir 3 are not equal and, above all, differ in the medium that is under the reservoirs. Under the reservoir 2 is the soil of the Earth, and under the reservoir 3 - the air. As it is known from quantum physics, the reflection coefficient from the boundary of two media depends on the properties of both media. In this case, the difference in the density of water and soil is much less than the difference between the densities of water and air, which causes a difference in the reflection coefficients. I.e. the reflection coefficient of the gravitational radiation of the Earth from the upper reservoir  $\kappa_1$  must be higher than the reflectance from the lower reservoir  $\kappa_2$ , which is the reason for the difference  $S$  between the theoretically calculated  $g_t$  and the actual value of  $\Delta g_\phi$  for both empty and filled reservoirs. The reflection coefficient characterizes the intensity of the reflected wave (energy) and depends on the nature of the waves and on the boundary conditions of the two media, i.e. reflecting the border between two different environments. The reflection coefficient in optics depends on the difference in the optical density of the media at the boundary of which reflection occurs. In acoustics and seismic, the reflection coefficient depends on the difference in density of the media at the boundary of which the reflection occurs. In any case, the greater the difference in density (optical or physical, depending on the type of waves) of the adjacent media, the higher the reflection coefficient from the boundary between them. Thus, the gravitational reflection coefficient is the ratio of the gravitational radiation flux reflected by the body (mass) to the radiation flux falling on it. Those the water in the reservoirs partially reflects and partially transmits the gravitational energy emitted by the Earth (gravitational quanta) or is partially transparent to them.

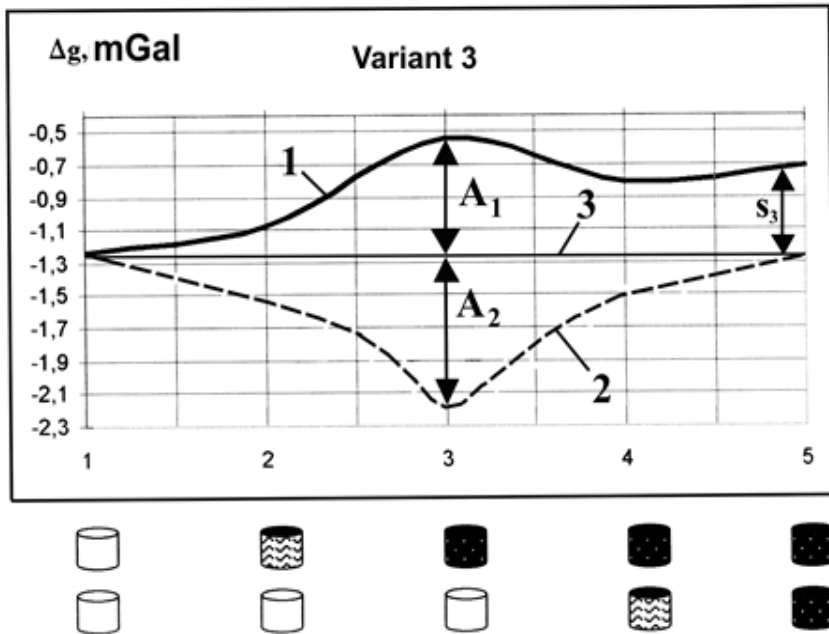
### **Variant 3.**

The first measurement of  $\Delta g_{\phi}$  is performed with empty reservoirs 2 and 3, Fig.8. The second measurement is performed when the upper reservoir is half-filled, while the actually measured  $\Delta g_{\phi}$  value increases in Graph 1, while the theoretically calculated  $\Delta g_t$  value decreases, as shown in Graph 2. This is due to the partial reflection of the Earth's gravitational quanta by the water mass in the reservoir 3. The third measurement is carried out with a completely filled reservoir 3 and an empty reservoir 2. The actually measured value  $\Delta g_f$  at the same time reaches the maximum value, while Theoretically calculated - minimal. This is explained by the fact that the growth of the force  $F_4$  resulting from the reflection of the gravitational quanta of the Earth when the upper reservoir is filled with water is significantly ahead of the increase in the force of attraction  $F_3$  of the water mass of the upper reservoir, i.e.  $F_4 > F_3$ . At the same time, as can be seen from the graphs in Fig.10 the amplitude  $A_1$  of the actual increase in  $\Delta g_f$  is less than the amplitude of the decrease in the theoretically calculated value of  $\Delta g_t$ , which is due to the partial compensation of the force  $F_4$  by the force  $F_3$ . Thus, at the third measurement of variant 3, the resultant force acting on the sensitive gravimeter mass is:

$$F = F_1 + (F_4 - F_3) \quad (1.9)$$

The fourth measurement is carried out with a completely filled upper reservoir 3 and a half filled lower 2. In this case, as it can be seen in Fig. 10, the actual value of  $\Delta g_{\phi}$  decreases, and the theoretical value increases. Consequently, the force of gravitational attraction  $F_1$  decreases by the magnitude of the force  $F_5$ , reflecting that part of the gravitational energy, which is partially reflected by the water mass of the lower reservoir 2. The fifth measurement is carried out with completely filled reservoirs 2 and 3. At the same time, the actual value of  $\Delta g_{\phi}$  slightly increases, while the theoretically calculated value increases significantly. This is due to the fact that the force of attraction  $F_2$  of the mass of a completely filled bottom reservoir 2 begins to partially compensate for the decrease in force  $F_1$  by the amount of force  $F_5$  caused by the reflection of a part of the energy of gravitational quanta emitted by the Earth by the water mass of the lower reservoir. Moreover, the growth of the influence of the force of attraction by the mass of water in reservoir 2 on mass 4 is also associated with the approach of the surface of the gravitating mass of water in reservoir 2 to the sensitive mass 4.





**Fig.8.**

However, the theoretical value of  $\Delta g_t$  differs from the actually obtained  $\Delta g_\phi$  by the value of  $S_3$  in accordance with formula (1.10).

$$S_3 = \Delta g_\phi - \Delta g_t \quad (1.10)$$

This difference, as mentioned above, is related to the difference in the reflection coefficients of the upper and lower reservoirs with water due to the difference in the properties of the media underlying reservoirs 2 and 3.

**Variant 4.**

The first measurement of  $\Delta g_\phi$  is carried out with reservoirs 2 and 3 fully filled. Fig.9. The second measurement of  $\Delta g_\phi$  is carried out with reservoir 3 and full reservoir 2, emptied of half of it. The value of  $\Delta g_\phi$  during the second measurement decreases (Fig.9.). While the theoretically calculated value of  $\Delta g_t$  increases. This is due to the fact that with a decrease in the mass of water, the gravitational energy reflected by it decreases, emitted by the Earth. Consequently, the force  $F_4$  acting on the mass 4 decreases and is partially compensated by the force  $F_3$  of attraction by the mass of water in the reservoir 3. The third  $\Delta g_\phi$  measurement is carried out with a completely empty

reservoir 3 and a full reservoir 2. At the same time, as it can be seen from graph 1 Fig.9. the value of значение  $\Delta g_\phi$  becomes minimal, whereas the theoretically calculated value of  $\Delta g_t$  in graph 2 has the maximum value. This is explained by the fact that by emptying the water in reservoir 3, the force  $F_4$ , the magnitude of which exceeded  $F_3$ , ceased to act on mass 4, and only the forces  $F_1$  and  $F_2$  began to act on it. At the same time, the amplitude  $A_1$  of the graph of actual values of  $\Delta g_\phi$  is approximately twice as low as the amplitude  $A_2$  of the graph of the theoretically calculated values of  $\Delta g_t$ .

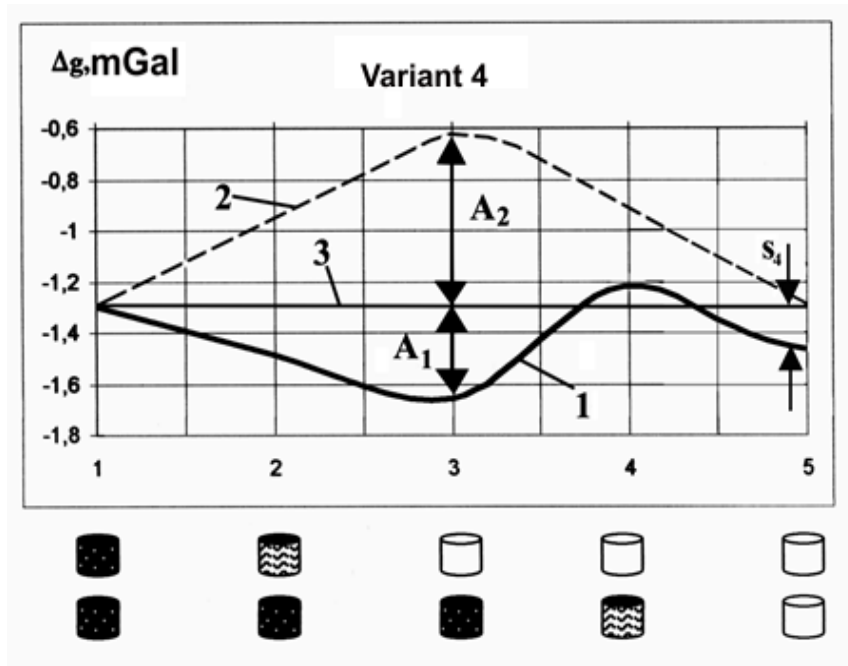


Fig.9.

This is due to the fact that the force  $F_2$  is partially compensated by the force  $F_5$ . Thus, at the third measurement of variant 2, the resulting force  $F$  is equal to mass 4 (Fig. 8):

$$F = F_1 + (F_2 - F_5) \quad (1.11)$$

The fourth measurement  $\Delta g_\phi$  is performed with an empty reservoir 3 and a half-empty reservoir 2. In Fig.9 it can be seen that the graph 1 of the actual measurements of  $\Delta g_\phi$  shows an increase in the force of gravity, whereas on the theoretically calculated graph 2 the force of gravity decreases. This is due to the fact that with a decrease in water in reservoir 2, the rate of decrease in the force  $F_5$  is ahead of the rate of decrease in the force of attraction  $F_2$  caused by the mass of water in reservoir 2, i.e. at some point

the decrease of water in reservoir 2, the values  $F_5 = F_2$ , and with a further decrease of water in the reservoir it turns out to be  $F_5 < F_2$ . I.e. as water decreases, the proportion of the force  $F_2$  of the attraction of water in reservoir 2 with respect to the force  $F_5$  continues to grow. The fifth measurement of  $\Delta g_\phi$  is carried out with reservoir 2 and 3 completely emptied. As can be seen from Fig.9, the value of  $\Delta g_\phi$  decreased due to a decrease in the gravitational force  $F_2$  of the mass of water in reservoir 2 to mass 4. At the same time, on a theoretically calculated graph 2, the value of  $\Delta g_r$  at the fifth measurement should be higher than the value of  $\Delta g_\phi$  during the actual measurement of the difference  $S_4$ . The difference in  $S_4$ , as in variants 1-3, is explained by the difference in the reflection coefficients of gravitational radiation for reservoirs 2 and 3, underlain by media with different densities, respectively, soil and air. As it is known, the effect of reflection in quantum mechanics is considered in conjunction with the effects of absorption, scattering, refraction, diffraction, etc. All these parameters can be derived based on consideration of the ratios of the theoretically calculated  $\Delta g_r$  and actually observed  $\Delta g_\phi$  values, as well as the nature of their change depending on the applied variations of the fill level of the lower and upper reservoirs. The various growth rates of attraction forces  $F_2$  and  $F_3$  compared to the growth rates of forces  $F_4$  and  $F_5$  are explained as follows. The force  $F_4$  with increasing mass of water in the reservoir 3 increases non-linearly with the advance of the growth rate of the force  $F$ , while the force of attraction of the mass of water  $F_3$  to mass 4 increases almost linearly (Fig.9, a), with a non-linear nature of the decrease in growth rates. This is due to a change in the center of the gravitating mass with increasing water in the reservoir, i.e. removing the center of mass of water in the reservoir 3 from the mass 4. In this case, as it is well known, the force of attraction should decrease inversely proportional to the square of the distance between the gravitating masses. As a result, at the first moment when the water in the reservoir 3 increases, the influence of the  $F_3$  force on mass 4 exceeds the influence of the  $F_4$  force; however, with the subsequent filling of the reservoir 3 with water, the value of the  $F_4$  force begins to significantly exceed the value of the  $F_3$  force. At the same time, when the lower reservoir 2 is filled with water, the force  $F_5$  also grows according to a non-linear law. Meanwhile, taking into account the quadratic dependence of the force of gravitational attraction on the distance to the gravitating mass, the force of attraction of water in reservoir 2 to mass 4 also increases quadratically, due to the approach of the center of mass of water to mass 4, but with a lower curvature than the force  $F_5$  (Fig. 9, b).

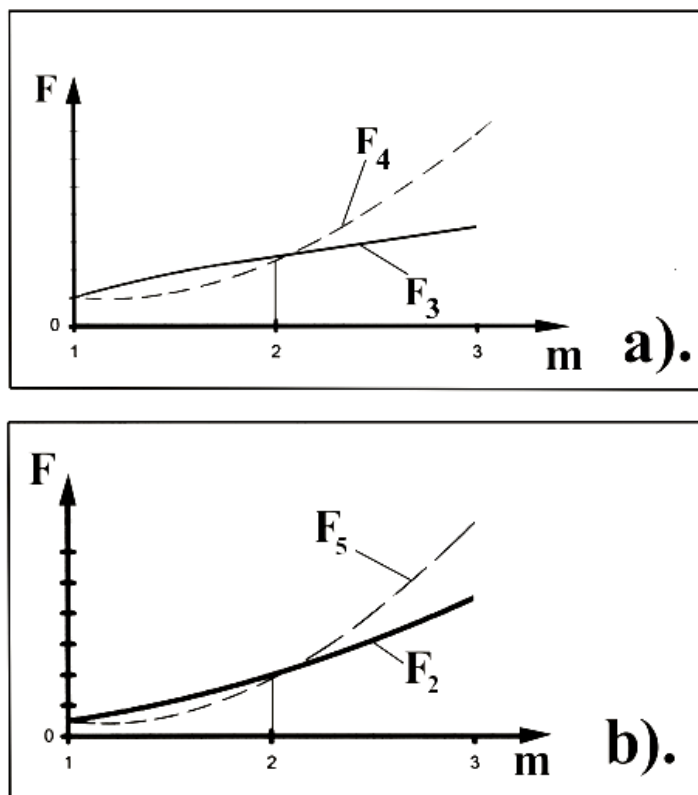


Fig.10

Thus, the experiments carried out on the G - QUANTUM installation allowed us to detect effects that can be explained only from the point of view of the quantum theory of gravity. Meanwhile, the discovery of such effects as gravitational shielding, gravitational reflection and gravitational permeability, creates many problems in changing many ideas in various areas of modern science.

#### 4. Experimental studies of the dynamics of the trial masses and gravitational quantum effects

(Khalilov E.N. Method for registering quantum gravitational radiation.  
PCT Pub. No.: WO / 2015/027299, PCT / AZ2013 / , Geneva)

The essence of the proposed method is that the weight of the trial mass made of non-magnetic dielectric material is monitored in order to eliminate the effect on the trial mass of electromagnetic fields and emissions. At the same time, the linear size of at least

one of the three parameters (length, width and height) must differ from the others by at least 50%, which is necessary to enhance the effect of changes in the angle of inclination (interaction area) of the trial mass on reception of gravitational radiation (radiant flux). The weight of the trial mass reflects the force of the gravitational interaction of the Earth and the trial mass. As is known from the law of world wideeness, the body weight  $P$  is equal to:  $P = mg$ , where  $m$  is the mass of the body,  $g$  is the acceleration of free fall ( $g = GM / r^2$ , where  $M$  is the mass of the Earth,  $r$  is the radius of the Earth, and  $G$  is the gravitational constant ) /14/. They install the trial mass on a high-precision balance and monitor the weight of the trial mass, by periodically weighing the trial mass with the maximum sampling rate, for a period of time that provides statistical veracity of the result. The shape of the trial mass is selected, depending on the type of recorded quantum effects and measured parameters (wavelength, absorption coefficient, gravitational permeability, reflection coefficient, etc.). For example, the trial mass may be in the form of a plate, an elongated solid cylinder, an ellipsoid of rotation, etc. Taking into account that the trial mass, in this case, plays the role of an antenna for gravitational quantum radiation, its shape directly affects the frequency response of the antenna. It is well known from physics that the length of the emitted wave is proportional to the linear parameters of the radiating system (antenna). Without speaking in details about the ratios of linear dimensions of radiating / receiving antennas and lengths of radiated / received electromagnetic waves that are well studied and described in the literature on electrodynamics, we note that the linear size of the antenna must be at least 0.4 of the length of the radiated / received wave. This ratio is also maintained for gravitational waves [15]. At the same time, measurements are carried out at different orientations of the trial mass relative to the horizontal plane, while maintaining the same height of the center of mass. This is achieved in the way that the trial mass is placed on the balance with the help of a support that holds the trial mass in its central part. This allows to keep the center of mass unchanged in height at any angles of inclination of the trial mass relative to the surface of the Earth. Maintaining the unchanged height of the center of mass of the trial mass is necessary to eliminate the effect of changes in the height of the center of mass on the weight of the trial mass, since the force of gravitational interaction between the masses (in this case, between the Earth and the trial mass) is inversely proportional to the square of the distance between them [16]. The pulses of changes in the trial mass are revealed at different positions of the orientation of the trial mass, the average amplitude and the average period of the registered pulses are determined, by which the frequency characteristics and the energy of the registered gravitational pulses are viewed. Changing the angle of inclination of the trial mass and registering gravitational impulses, choose the angle at which the amplitudes of the recorded impulses have the maximum value. Knowing the change in weight of the trial mass in a

pulse, one can calculate the intensity of the gravitational pulse. Just as with electromagnetic radiation [17], the intensity of gravitational radiation is the average, over time, energy transferred per unit of time by gravitational radiation through a unit area, perpendicular to the direction of propagation of the gravitational wave. The intensity of the gravitational pulse IG is measured in  $W / m^2$ . To determine the effect of material properties on the parameters of quantum effects, trial masses of the same shape and dimensions, made of different materials, are weighed at different angles of inclination, reveal the difference in weight of the trial masses of different materials under equal weighing conditions, according to which the parameters of the quantum effects depend from the material of the trial mass. This, above all, is about such parameters as the coefficient of gravitational permeability and the coefficient of gravitational reflection. To determine the parameters of the background gravitational radiation, measure the average weight of the trial mass at different positions, determine the difference in weight, depending on the orientation of the trial mass, which is used to view the background value of the parameters of gravitational quantum radiation. To determine the direction to the source of gravitational radiation, sequentially, discretely, change the azimuth of the orientation of the trial mass at an angle from  $0^\circ$  to  $360^\circ$  and with each change of the azimuth angle, change the weight of the trial mass at different angles of inclination with the maximum possible sampling rate, record the gravitational pulses quantum radiation and determine the angle of inclination of the mass and the azimuth angle at which the maximum amplitude of the pulse is recorded, and by the angle of inclination of the trial mass and azimuth n gate view the direction of the source of gravitational radiation. The method is as follows. The trial mass is made of a non-magnetic dielectric material, and the linear dimension of at least one of the three parameters of the trial mass (length, width, and height) is different from the others by at least 50%. As an example, the results of the experiments conducted by the author are given. In Fig.11 is shown the weighing a trial mass made of polystyrene in the shape of a rectangular plate. A balance 2 is placed on the horizontal surface 1, on which the trial mass 3 is installed using a support 4, which holds the trial mass 3 in its central part 5 and provides the possibility of changing its angle of inclination relative to the horizontal plane 1. The weight of the trial mass is monitored at the highest possible sampling rate for a period of time ensuring the statistical reliability of the result. Each measurement of the weight of the trial mass is made at different angles of inclination of the trial mass, relative to the horizontal plane. Fig.11. (A) shows the measurement of the weight of the trial mass at a tilt angle of  $0^\circ$  with respect to the horizontal plane. Fig.11. (B) shows the measurement of the weight of the trial mass at an inclination angle of  $45^\circ$ .

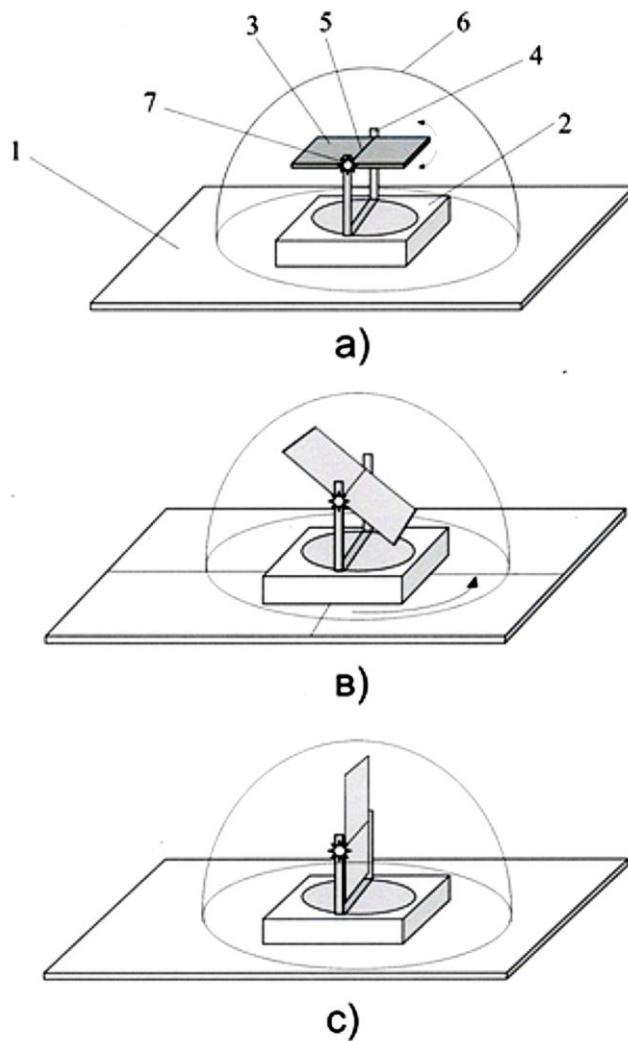
Fig. 11 (C) shows the measurement of the weight of the trial mass at an inclination angle of  $90^\circ$  with respect to the horizontal plane. They measure the difference in the

weight of the trial mass, depending on the angle of inclination, which is viewed on the energy and wavelength of the recorded gravitational quantum radiation. To do this, they determine the average value of the change in weight of the trial mass for the entire monitoring period at each angle of the trial mass.

They build the trend of the dependence of the average values of weight changes of the trial mass on the angle of the trial mass, which is viewed on the intensity of the background radiation. As it is known from physics, if the length of an electromagnetic wave substantially exceeds the thickness of the barrier (screen) in front of it, then in this case, the barrier is “transparent” for the wave to pass, practically without energy loss. Meanwhile, as the thickness of the barrier approaches the wavelength, the ability of the barrier to absorb and reflect the radiation energy increases. When the barrier thickness of 0.4 is exceeded, the length of the gravitational wave, the reflective and absorbing abilities of the obstacle become tangible. This, partial shielding and absorption of gravitons, can explain the change in the difference in weight of the trial mass, depending on its slope. With the horizontal position of the trial mass in the form of a plate, its thickness with respect to gravitational radiation, directed perpendicular to the plane of the plate, is minimal. Taking into account that the change in weight of the trial mass, at its horizontal position, is minimal, we can conclude that the wavelength of gravitational radiation exceeds the thickness of the trial mass in the form of a plate.

Meanwhile, an increase in the slope angle of the trial mass increases the thickness of the screen relative to the gravitons passing through it, therefore, an increase in the weight of the trial mass is observed. At an inclination angle of  $90^\circ$ , the screen thickness becomes maximum and, judging by the significant increase in the change in weight of the trial mass, comparable with the wavelength of gravitational radiation. For a more accurate determination of the wavelength of gravitational radiation, the linear dimensions of the trial mass must continue to increase until the amplitude of the pulses of the weight of the trial mass becomes unchanged, regardless of further increasing the thickness of the screen. The thickness of the screen at which the amplitude of the pulses of the weight of the trial mass becomes unchanged is taken as the wavelength of gravitational radiation.

Fig. 12 (A) shows the identification, in the process of monitoring, of pulses “i” of changes in the weight of the trial mass, on the graphs of changes in the weight of the trial mass L, M, N, at the angles of inclination of the trial mass, respectively:  $0^\circ$ ;  $45^\circ$ ;  $90^\circ$ . Determine the average amplitude of the registered pulses and build the trend of the dependence of the average amplitudes of the pulses of the trial mass on its angle of inclination, shown in Fig. 12 (B).

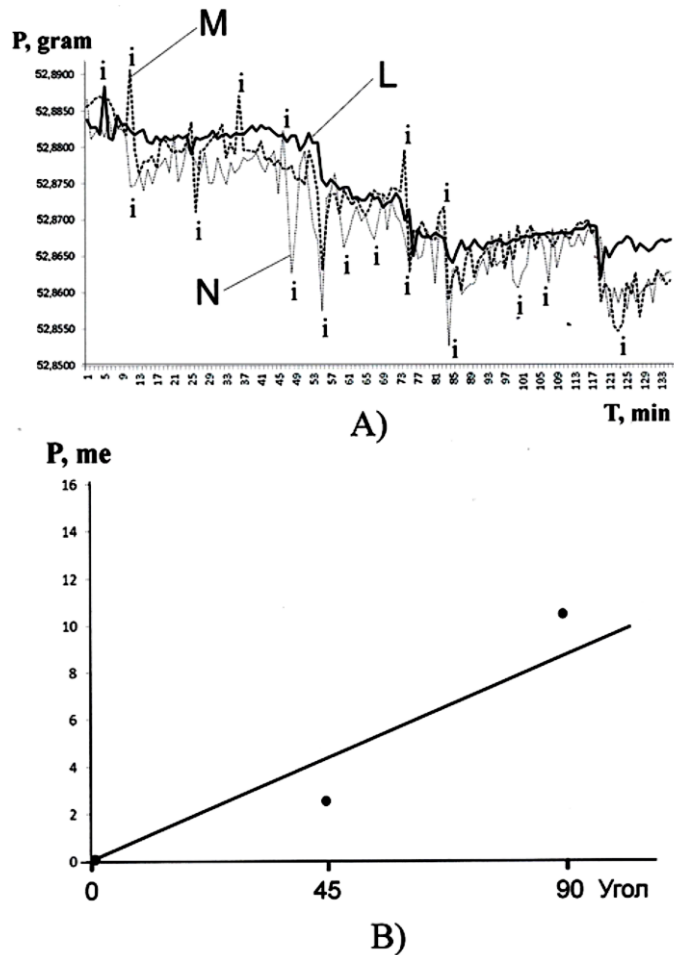


**Fig.11.**

The trend allows you to determine the wavelength of gravitational radiation in a pulse, based on the method described above.

The average period of the pulses is determined, and on the basis of the average amplitudes and periods of the pulses, changes in the weight of the trial mass are viewed, the frequency response of the gravitational quantum pulses is viewed.

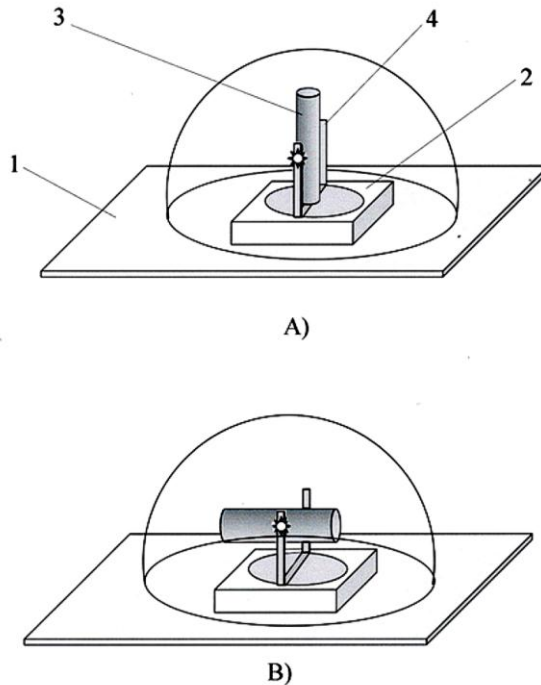




**Fig.12. In the process of monitoring, revealing of pulses “i” of changes in the weight of the trial mass on the graphs of changes in the weight of the trial mass L, M, N, at the angles of inclination of the trial mass, respectively: 0°; 45°; 90°. A) Graphs of variations in the weight of the trial mass over time depending on the angle of inclination. B) The straight-line trend of the dependence of the average amplitudes of the pulses of the weight of the trial mass on the angle of its inclination**

To demonstrate the influence of the trial mass shape on the registration parameters of gravitational quantum radiation, in Fig. 13. shows an example of monitoring the weighing of the sample mass in the form of a solid cylinder. In Fig. 13 (A) on a horizontal surface 1, there are placed scales 2, on which trial mass 3 is mounted, fixed in the middle on support 4.

Mass is set at an angle of  $90^\circ$  to the horizontal plane. In the second case, Fig. 13 (B) the mass is set in a horizontal position (at an angle of  $0^\circ$ ).



**Fig.13.**

In Fig. 14. (A) authors experimentally show the results of monitoring the weight of the trial mass of a cylindrical shape at the two angles mentioned above. As it can be seen in the graphs, in this case, very intense and short pulses are recorded on graph F, which differ from graph K. Taking into account that in this case the pulses are more pronounced, we can conclude that the frequency response of a gravitational quantum antenna in the form of a solid cylinder, closest to the frequency response of the registered pulses of gravitational quantum radiation. It cannot be excluded that the registered gravitational impulses are of cosmic origin and reflect large emissions of gravitational energy from a gravitating body in outer space. Fig. 14 (B) shows, experimentally obtained by the authors, the trend of the dependence of the average amplitude of the recorded pulses of the weight of the trial mass in the form of a continuous cylinder on its angle of inclination. It is noteworthy that, despite some difference in the amplitude

and periods of the recorded pulses of the weight of trial mass in the form of a rectangular plate and a solid cylinder, their trends in the dependence of the average amplitude of the recorded pulses of the weight of the trial mass on its angle of inclination coincide, which indicates the efficiency quantum effects.

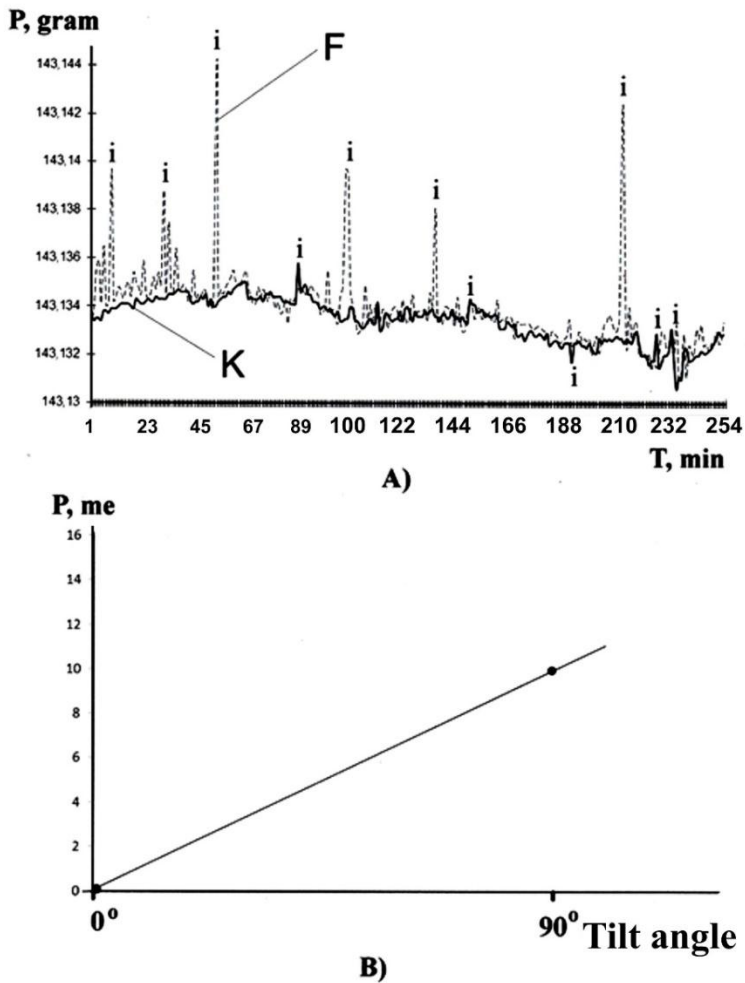
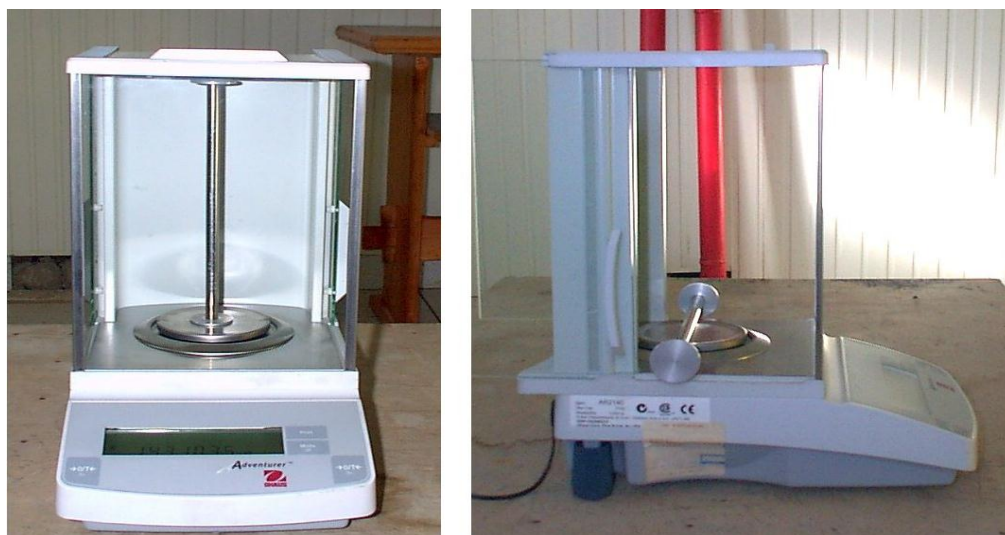


Fig. 14.

To determine the influence of the properties of different materials on changes in quantum effects, weighting trial masses of the same shape and size, made of different materials at different angles of inclination, reveal the difference in weight of the trial masses of different materials under equal weighing conditions, according to which the parameters of quantum effects from trial mass material. To determine the direction to the source of gravitational radiation, they measure the azimuth of the trial mass orientation changes from 0 ° to 360 ° and at each change of the azimuth angle the

changes in the weight of the trial mass at different angles of inclination with possible frequency of sampling are monitored, register the pulses of gravitational quantum radiation and determine the angle of inclination of the mass and the azimuth angle at which the maximum amplitude of the pulse is recorded. On the angle of the trial mass and the azimuth of rotation, the direction to the source of gravitational radiation is viewed. The photographs (Fig. 15) show the measurement of the weight of the trial mass in the vertical A) and horizontal B) positions on an analytical balance of a special class, with an accuracy of  $10^{-4}$  gr. “Adventurer Ohaus”

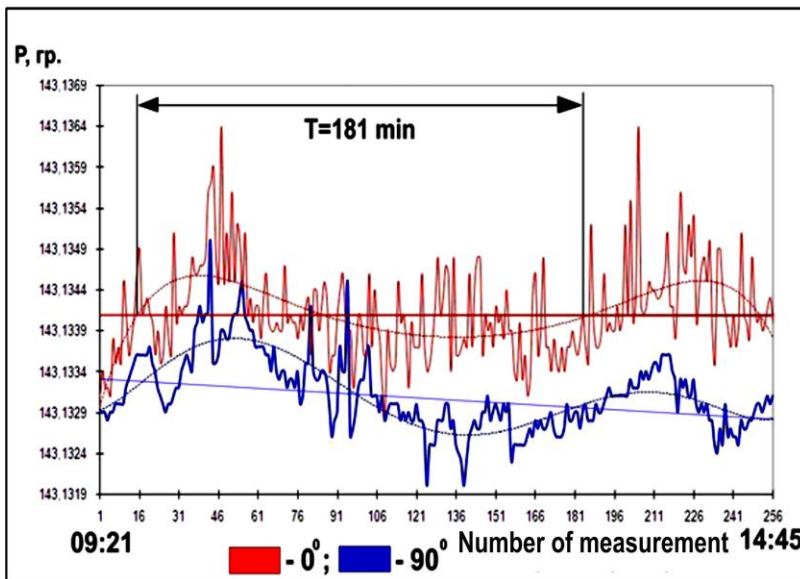


A) B)

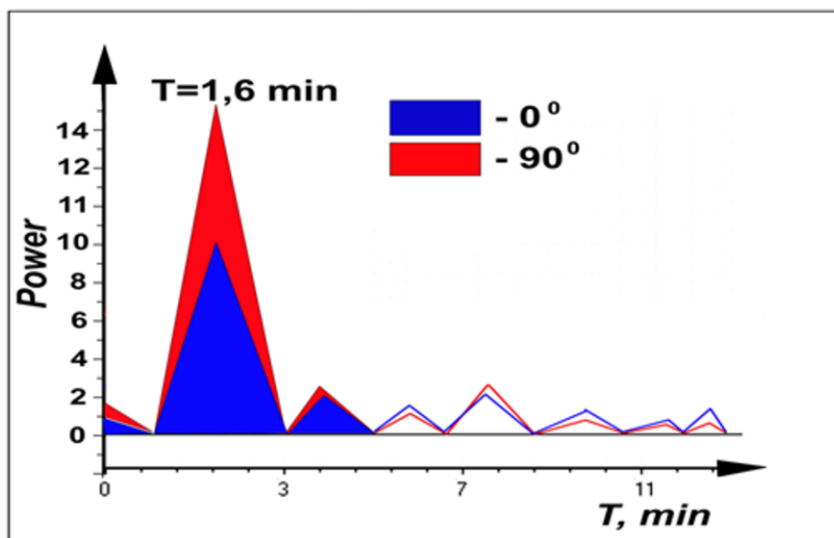
**Fig.15. Monitoring the weight of the trial mass in the form of an aluminum rod in the vertical A) and horizontal B) positions on the analytical scales of a special class, with an accuracy of  $10^{-4}$  gr. “Adventurer Ohaus”.**

Fig. 16 shows a graph with the results of this experiment, which was carried out in Baku, in the building of the SRI for Forecasting and Studying the Earthquakes, 04/12/2018, measurement time: 09:21 - 14:45. The measurement was carried out with the trial mass (aluminum bar) in a horizontal position (angle  $0^\circ$ ) and in a vertical position (angle  $90^\circ$ ). First, the approximation of graphs using a trend allowed us to establish the presence of a variation with a period of 181 minutes, which may be a reflection of the Earth’s own resonant frequency of oscillations. The first natural oscillations of the Earth with a period of 57 min were discovered by Benioff in 1952 after the earthquake on Kamchatka [18]. Earth oscillations with a period of 54 min after the Chilean earthquake in 1960 were recorded. Since the Earth is not very homogeneous

and has a very complex structure, the natural oscillations have a rather rich spectrum containing a series of periods from 30 to 200 minutes. The difference in the periods of the Earth's natural oscillations may also be due to the influence of some exogenous and endogenous factors [19, 20]. In this experiment, the condition of the constant position of the center of mass of the test body (aluminum rod) was not observed. Therefore, the different position of the graphs along the P axis (the trend of the weight of the rod in the horizontal position above the trend of the weight of the rod in the vertical position) is due to the gradient of gravity due to the difference in height of the centers of mass. This is because the center of mass of the rod in a horizontal position closer to the center of the Earth, compared with the center of mass of the rod in a vertical position. Meanwhile, when considering the graphs, it can be seen that in the horizontal position of the rod, the oscillation amplitude is significantly higher than with the vertical position of the rod. In addition, short pulses are much better pronounced than when the rod is located in a vertical position. This feature was steadily observed in more than 100 experiments. The result obtained allowed the author to assume the presence of a powerful source of gravitational pulses having a specific frequency spectrum of gravitational radiation. According to the author, the wavelength of the main part of the spectrum of gravitational radiation can be commensurate with the thickness of the rod and significantly below its length.



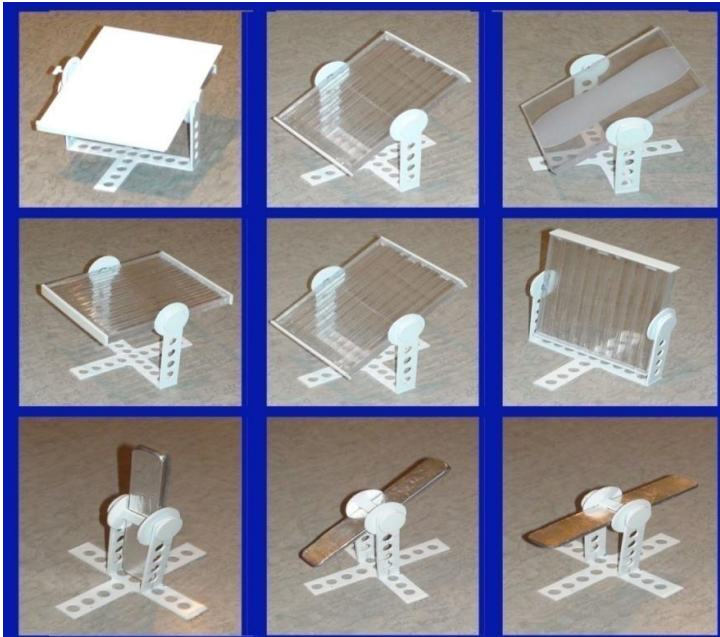
**Fig.16. Graphs of variations in time of the weight of the trial mass in the form of an aluminum rod in vertical and horizontal positions. Baku, SRI for Forecasting and Studying the Earthquakes, 04/12/2018, Time: 09:21 - 14:45**



**Fig.17. The periodogram of the power of variations in time of the weight of the trial mass in the form of an aluminum rod in vertical and horizontal positions. Baku, Scientific Research Institute for Forecasting and Studying the Earthquakes Prediction, 04/12/2018, Time: 09:21 - 14:45**

Thus, the rod can play the role of a narrowly directed gravitational antenna that detects gravitational radiation of a certain frequency. Meanwhile, to determine the direction to the radiation source, there are not enough measurements at one point and at two positions of the trial mass (horizontal and vertical). It is necessary to measure at at least three points located at the maximum distance from each other and at different angles of the rod relative to the horizontal. Fig. 17 shows the power spectrum (power periodogram) of the recorded gravitational pulses for the horizontal and vertical positions of the rod. As it can be seen in the spectrum, the period of the main pulses is  $T = 1.6$  min. Thus, we see that the recorded oscillations of gravitational radiation are pronounced pulses with a period of 1.6 minutes, the amplitude of which depends on the spatial orientation of the trial mass (rod). For further verification of the concept of the author, special trial masses were made, allowing them to change the angle of inclination while maintaining the height of the center of mass relative to the surface of the earth, Fig.18., Fig.19 shows the placement of trial masses on high-precision scales at three different angles of inclination of the masses:  $0^\circ$ ,  $45^\circ$  and  $90^\circ$ . In the next experiment we carried out the weighing (monitoring in time) of the trial mass on June 19, 2017 in the period from 21:35

- 23:25. The results were very interesting. As it can be seen from the graphs of Fig.20, the highest amplitude of the pulses and their best expression was observed at a slope of the trial mass of  $45^\circ$ , and the smallest amplitude was observed at a slope of  $0^\circ$ . When considering polynomial trends, it can be seen that, at an angle of  $90^\circ$ , the intersection of trends occurs at trial angle tilt angles of  $45^\circ$  and  $90^\circ$  at measurement point No. 26 and trends intersect at  $90^\circ$  and  $0^\circ$  tilt angle at measurement point No.36. Thus, we can see that the ratio of the amplitudes of the pulses at different angles of inclination of the trial masses is not stable and depends on the measurement time. In our opinion, this indicates that the source of gravitational impulses is constantly shifting relative to the trial masses, which may indicate its cosmic origin. If this source of gravitational impulses has a cosmic origin, then the rotation of the Earth around its axis, the rotation of the Earth around the Sun and the Solar System around the center of the Galaxy, should cause a constant displacement of the source of gravitational radiation with respect to trial masses. This process can justify the intersection of trends in the weight of trial masses at different tilt angles.



**Fig.18. Various trial masses, allowing to change the angle of inclination while maintaining the height of the center of mass relative to the surface of the Earth**

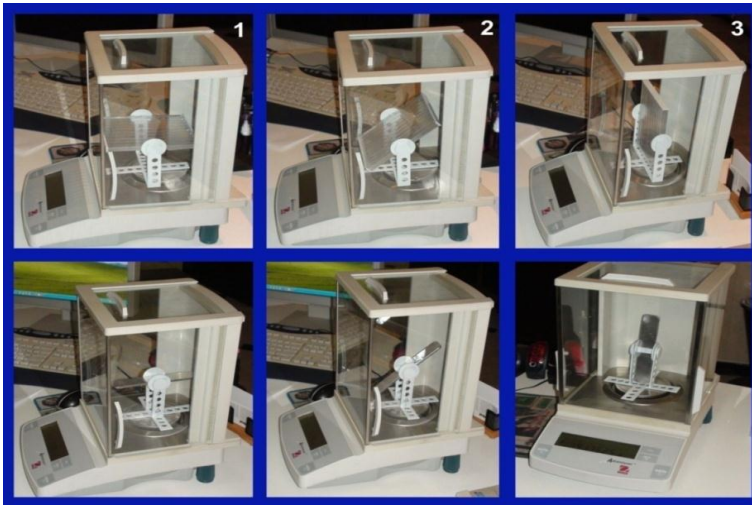


Fig.19. Placing the trial masses on high-precision scales at three different angles of inclination of the masses:  $0^\circ$ ,  $45^\circ$  and  $90^\circ$ .

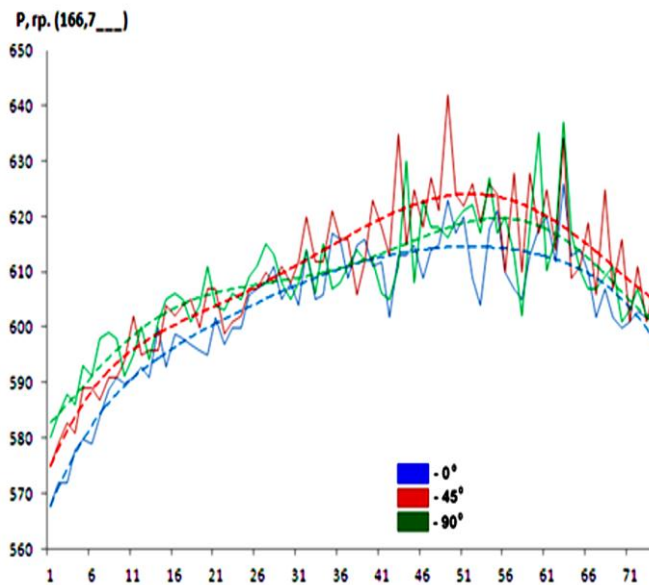
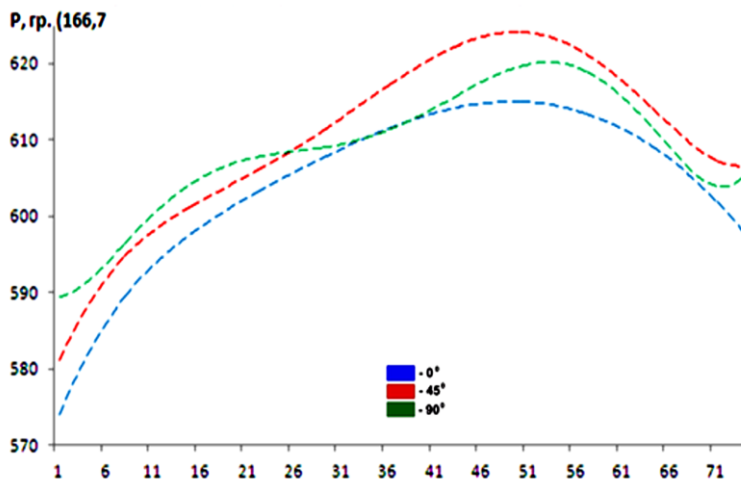


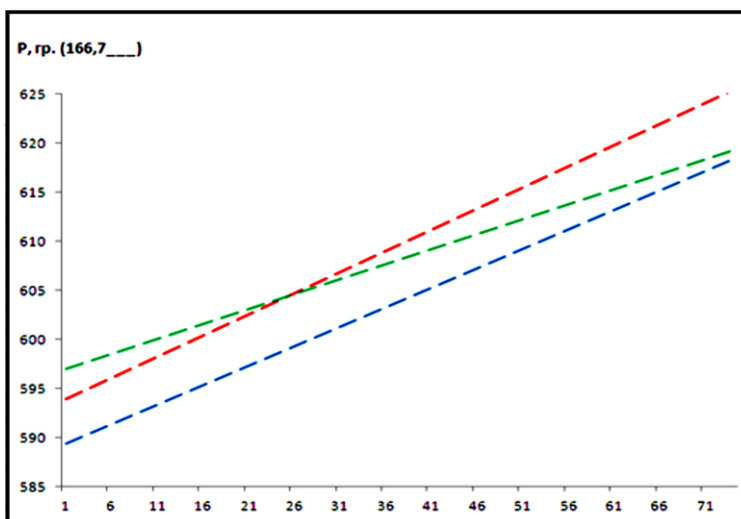
Fig.20. The graph of the dynamics over time of the weight (P) of a rectangular flat trial mass of polycarbonate. Baku, 19.06.2018 Monitoring time is 21:35 - 23:25. Measurements were made at angles: 0; 45; 90 degrees relative to the horizontal plane.





**Fig.21. Polynomial trends of weight dynamics (P) of a rectangular flat trial mass of polycarbonate. Baku, 19.06.2018 Monitoring time: 21:35 - 23:25. Measurements made at angles: 0; 45; 90 degrees relative to the horizontal plane.**

As it can be seen from rectilinear trends, there is an intersection of trends at angles of 45° and 90° at measurement point No.26, which allows us to specify the result of the analysis of polynomial trends.



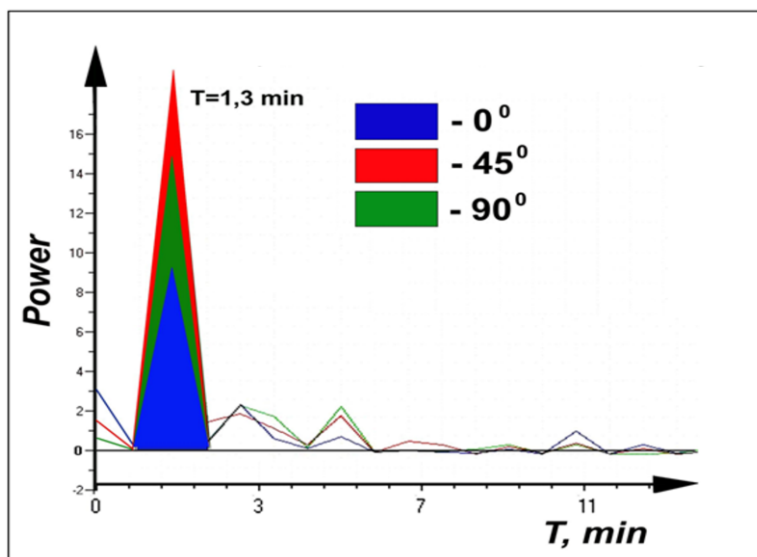
**Fig.22. Rectilinear trends of weight dynamics (P) of a rectangular flat trial mass of polycarbonate. Baku, 19.06.2018 Monitoring time: 21:25 - 23:25. Measurements made at angles: 0; 45; 90 degrees relative to the horizontal plane.**

The research of the power spectrum shown in Fig. 23 showed that the greatest power of gravitational radiation is observed about the inclination angle of the trial mass of  $45^\circ$ . This also confirms our conclusion based on trend analysis. Thus, it can be assumed that the direction to the radiation source of gravitational pulses with respect to the trial mass is closest to  $45^\circ$  relative to the horizontal plane.

## CONCLUSIONS

In this research paper there are given the results of studies on the possibility of recording gravitational quantum effects using two types of independent experiments.

In the first experiment, deviations of experimental measurements of  $\Delta g$  variations from the theoretically calculated  $\Delta g$  values were recorded under the influence of changes in water mass in two tanks of 25 tons each, located above and below high-precision quartz gravimeters. Analysis of the difference between the actually recorded and theoretical values of gravity allowed the author to propose his own model for explaining the results obtained. According to this model, the recorded deviations can be explained by the influence of gravitational quantum effects, in particular, such as the presence of gravitational permeability, gravitational absorption and volume gravitational reflection of the medium.



**Fig.23. Periodogram of monitoring the dynamics of weight (P) of a rectangular flat trial mass of polycarbonate. Baku, 19.06.2018 Monitoring time: 21:25 - 23:25. Measurements made at angles: 0; 45; 90 degrees relative to the horizontal plane.**

In the second experiment, the author experimentally established for the first time the change in weight of a trial non-spherical mass with a large ratio of length to thickness, depending on its spatial orientation and while maintaining the center of mass unchanged. The author concluded that non-spherical masses with a large ratio of length to thickness play the role of antennas of gravitational quantum radiation.

The rotation of such masses relative to their center, while maintaining the location of the center of mass unchanged, according to Newton's theory of gravity and the General Theory of Relativity, should not affect their weight if the sizes of the trial masses are negligible compared to the mass of the gravitating body.

Meanwhile, experiments have shown that changing the weight of trial masses of non-spherical shape with a large ratio of length to thickness depends on their angle of rotation, relative to the center point. This is also confirmed by spectral analysis. The weight of the trial mass was measured with an accuracy of  $10^{-4}$ gr and deviations were recorded at a level of  $10^{-3}$ gr. In addition, the experiments allowed to establish that, depending on the spatial orientation of the trial mass, the amplitude of the recorded gravitational pulses (pulses of change of the weight) varies, which can be explained by the presence of the radiation pattern of the trial mass when registering gravitational pulses. The author made the assumption that the source, registered experimentally, powerful gravitational impulses, may have a cosmic nature. In both cases, more than 100 experiments were conducted for each type of research, which statistically confirmed the results obtained.

### References

1. Einstein A. Sitzungsber. Preuss. Akad. Wiss., 1916, 688.
2. Einstein A., Infeld A. Evolution of Physics. Moscow, Science, 1965, 326 p.
3. Khalilov E.N. About possibility of experimental finding out the gravitational quantum effects. Science Without Borders. Transactions of the International Academy of Science H&E. Volume 2. 2005/2006. pp. 204-217.
4. Planck's constant. Physical encyclopedic dictionary. M., Soviet Encyclopedia. 1983, p.544
5. Spin. Physical encyclopedic dictionary. M., Soviet Encyclopedia. 1983, p.713.
6. Einstein A. Einheitliche Theorie von Gravitation und Elektrizität. (Mit W. Mayer), Sitzungsber. preuss. Akad. Wiss. phys.-math. Kl., 1931, 541-557.
7. Equivalence principle. Physical encyclopedic dictionary. M., Soviet Encyclopedia. 1983, p. 860
8. Feynman R. KED The Strange Theory of Light and Matter. M., Science, 1990, 205 p.
9. Bronstein V.A. How is the moon moving? M., Science, 1990, 205 p.
10. Einstein A. Gravitationswellen. Sitzungsber. Preuss. Akad. Wiss., 1918, 1, 154-167
11. Nicholson I. The black holes and the universe. M. Mir, 1983, 240 p.
12. Khalilov E.N. Gravitational waves and geodynamics. Baku-Berlin-Moscow. Elm – ICSD/IAS H&E, 2004, 330 p.

13. Khalilov E.N. Method for recording gravity quantum effects and device for carrying out said method. PCT. WO 2005/054901, 16/06/2005, Geneva.
14. Mass. Physical encyclopedic dictionary. M., Soviet Encyclopedia. 1983, p.
15. Khain, E.N. Khalilov. Cyclical geodynamic processes: its possible nature. Moscow, Scientific World, 2009, pp. 427-428.
16. Khalilov E.N. Method for registering quantum gravitational radiation. PCT Pub. No. : WO / 2015/027299, PCT / AZ2013 / 000006, Publication Date: 03/05/2015
17. The intensity of radiation. Physical encyclopedic dictionary. M., Soviet Encyclopedia. 1983, p.222
18. Aki K., Richards P. Quantitative seismology. M., Mir, 1983, v.1, p. 341
19. Bogdanov Y.A. Experimental studies of the natural oscillations of the Earth in Antarctica and Ukraine in electromagnetic radiation. Geophysical journal №1, v.33, 2011, p.80-90.
20. Petrova L.N., Volkov V.A. Dynamic features of seismogravitational oscillations of the Earth. Reports of the Academy of Sciences of the USSR, 1996, vol. 351, No. 5, p. 683-686.
21. Nolting F., Schurr J., Schlamminger St., and Kündig W. Determination of the gravitational constant of the balance sheet. Physics Institute, University of Zurich, Zurich, Switzerland. Europhysics News (2000) Vol. 31 No 4

## **ON THE ORBITAL EVOLUTION AND ORIGIN OF COMET 67P/CHURYUMOV–GERASIMENKO**

**Rustam Guliyev**

*Shamakhy Astrophysical Observatory of  
Azerbaijan National Academy of Sciences  
[rustamdb@gmail.com](mailto:rustamdb@gmail.com)*

### **Abstract**

The orbital evolution of the comet 67P/Churyumov–Gerasimenko have been examined in order to find out the influence of big planets, particularly Jupiter, in this. We have also tried to determine the possible place of the comet origin during long-term integration aswell as its dynamical lifetime. To perform the simulation. We created multitude comet's virtual orbits in confidence interval using covariance matrix. We also included non-gravitational forces into the simulation: A1, A2 and A3 according to Marsden-Sekanina model, as well as relativistic perturbations from the Sun. It is shown that dynamical evolution of 67P is strongly controlled by Jupiter. Results are discussed.

## **Introduction**

The study of comets is essential for understanding the formation and evolution of the Solar system. Comets contain a primordial substance as well as being tracers in the architecture that have been remained since the planets migration. Comet 67P/Churyumov–Gerasimenko was discovered by Klim Ivanovich Churyumov on 23 October 1969, during processing photographic plates that had been exposed for comet 32P/Comas Sola by Svetlana Ivanovna Gerasimenko on 11 September 1969 at Alma-Ata. 67P/Churyumov–Gerasimenko is a short-period comet of Jupiter-family comets (hereafter JFC) with the period of 6.45 years.

67P/C-G has been selected as the new target for the Rosetta mission (ESA) after the failure of the probe launch for an encounter with 46P/Wirtanen in 2002. Since that time the comet has become the focus of research for many astronomers. There are some works devoted to this problem can be highlighted [1, 2, 3, 4, 5].

## **Initial conditions**

The present research is based on the data grabbed from JPL Horizons system. All numerical calculations presented here are based on the numerical ephemeris DE431 of the Solar System. The starting epoch of integration JD2455491.5 (2010-Oct-22) was accepted for all further calculations. Orbital parameters of the 67P/C-G are given in the next table. They also conclude non-gravitational parameters  $A_1$ ,  $A_2$ ,  $A_3$ , according to the Marsden model. Minimum orbit intersection distance (MOID) with Jupiter and the Earth. Angular elements ( $i$ ,  $\omega$ ,  $\Omega$ ) are referred to Equinox J2000.0. Table 1 also identifies the uncertainties of the orbital elements ( $1\sigma$ ). In addition, the table shows Tisserand invariant ( $T_{jup}$ ) regarding to Jupiter.

## **Methods and calculations.**

To determine the orbital past of 67P/C-G, we have chosen the Bulirsch–Stoer algorithm which is very accurate and also can handle close encounters [6]. Moreover, we have made 100 of cometary orbit clones using covariance matrix of orbital elements within confidence interval. Since the comet experienced several close encounters with Jupiter, especially notable were those in 1959 and 1923 (less than 1 au). The non-gravitational force due to the cometary outgassing is introduced in the equation of

motion as Marsden [7]. The non-gravitational perturbing acceleration is given by its radial, transverse, and normal components in the equatorial heliocentric frame as:

$$A_{NG} = A_1g(r)E_R + A_2g(r)E_T + A_3g(r)E_N$$

where

$$g(r) = 0.111262 \left( \frac{r}{2.808} \right)^{-2.15} \left( 1 + \left( \frac{r}{2.808} \right)^{5.093} \right)^{-4.6142}$$

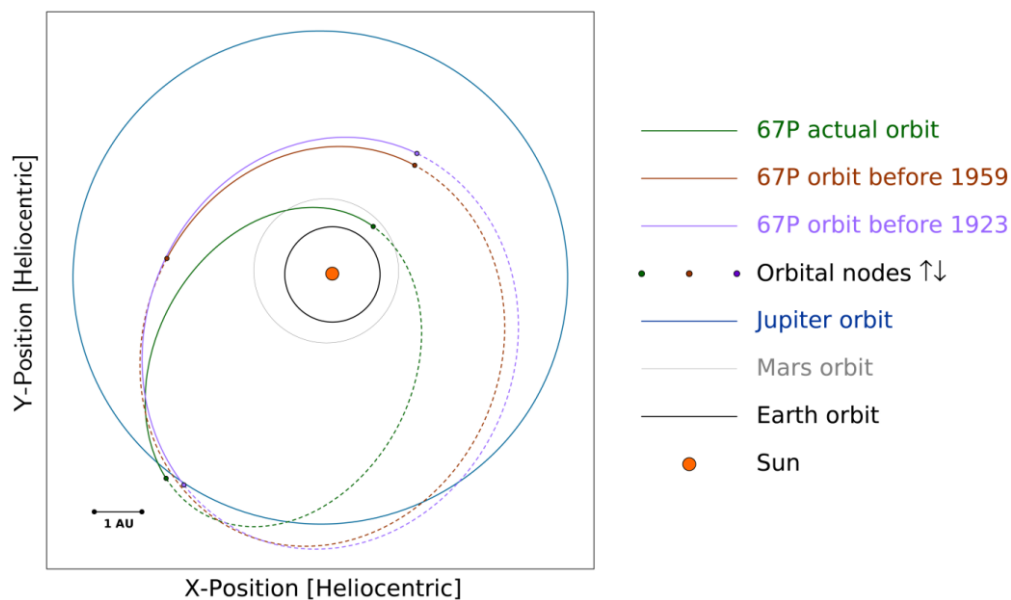
and  $A_1, A_2, A_3$ , are constants obtained by fitting the astrometrical positions of the considered comet together with the orbital elements. The vector  $E_R, E_T$ , and  $E_N$  are the radial, transverse, and normal direction vectors, respectively. The dimensionless function  $g(r)$  represents the variation in the sublimation rate as a function of the heliocentric distance of the comet  $r$ .

Table 1

**Orbital parameters of 67P with known uncertainties**

Parameter	Value	Error ( $1\sigma$ )
$e$	0.640582323	4.32E-08
$a$ (au)	3.464737503	2.33E-08
$q$ (au)	1.245287903	1.50E-07
$i$ (deg)	7.043680713	3.80E-06
$\Omega$ (deg)	50.18004588	5.38E-05
$\omega$ (deg)	12.6944641	5.42E-05
$Q$ (au)	5.684187102	3.83E-08
$A_1$ (au/day <sup>2</sup> )	1.07E-09	1.78E-11
$A_2$ (au/day <sup>2</sup> )	-3.69E-11	4.50E-12
$A_3$ (au/day <sup>2</sup> )	2.49E-10	1.58E-11
Period (years)	6.45	6.52E-08
Earth MOID (au)	0.259416	—
Jupiter MOID (au)	0.083694	—
$T_{Jup}$	2.746	—

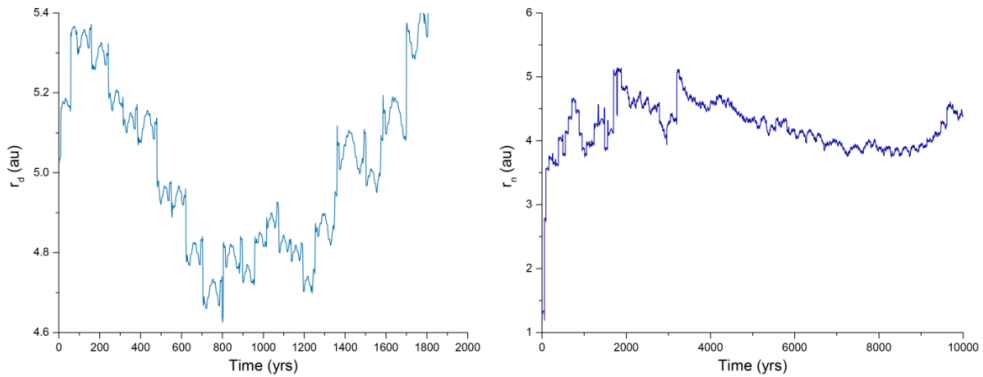
Fig.1 shows perturbations of the comet orbit as a result of close approaches with Jupiter in 1959 (0.05 au) so that perihelion distance reduced from 2.65 a.u. to 1.25 au., the eccentricity increased from 0.39 to 0.64, inclination decreased from 23to 7 and orbital period shortened from 9 years to 6.45 years. And another one in 1923 (0.28 au).



**Fig. 1. Real presentation of the 67P/C-G cometary orbits (All data given in relation to Equinox J2000.0. It also shows orbits of Jupiter, Earth and Mars).**

### Results of integration

At the next series of plots, we raise those examples to show the past of 67P/C-G orbital elements and dynamical connection with Jupiter.

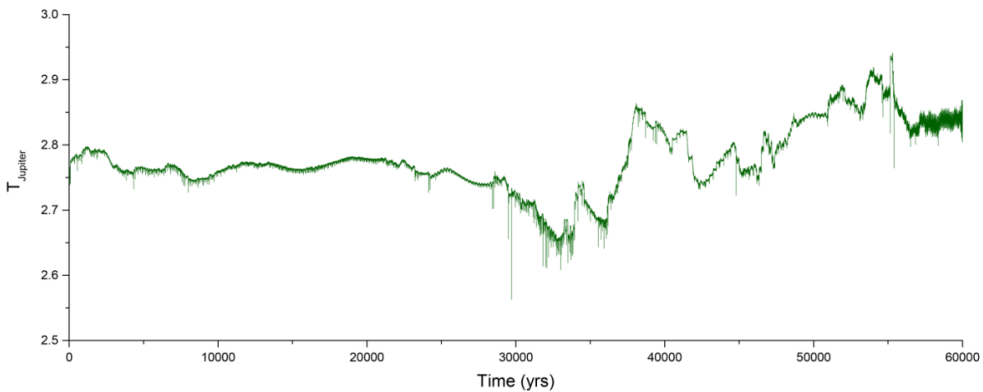


**Fig. 2. Dynamics of orbital nodes ( $\Omega$ ,  $\vartheta$ )**

Fig. 2 shows dynamics of distant (descending) and near (ascending) orbital nodes. As can be seen on the plots, nodes are located near of Jupiter orbit. During the evolution nodes are inverted. We can get them by using following equation:

$$r_{d,n} = a_c \frac{1 - e_c^2}{1 \pm \cos \omega}$$

where  $a_c$  and  $e_c$ – semi-major axis and eccentricity of the cometary orbit,  $\omega$ – argument of perihelion in the new reference system (regarding Jupiter).



**Fig. 3. Tisserand's constant of 67P/C-G as a function of time**

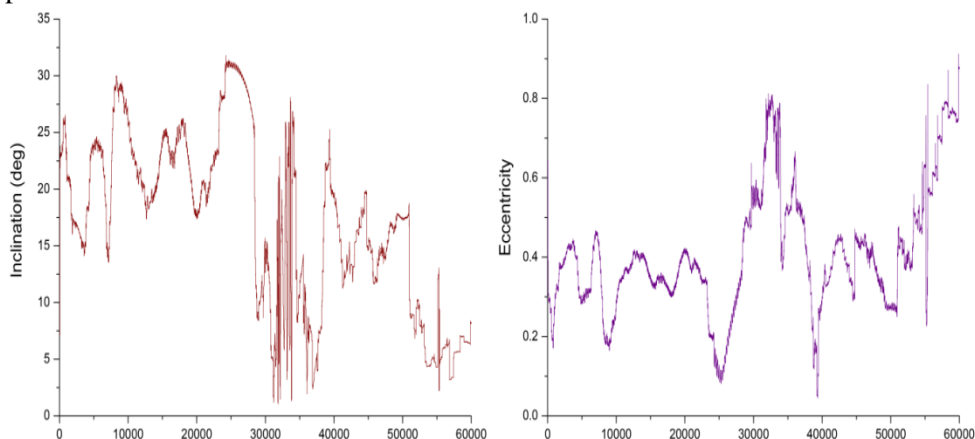


### Evolution of $a$ , $Q$ and Tisserand's constant

Is the one of the most important dynamic criteria for comets. In astronomical literature is usually represented as:

$$T_p = \frac{a_p}{a} + 2 \cos i \left[ (1 - e^2) \frac{a}{a_p} \right]^{0.5}$$

where  $a, e, i$ – semi-major axis, inclination and eccentricity of cometary orbit,  $a_p$ – semi-major axis of perturbing body (in this formula eccentricity of planet is equated to zero). Value of the parameter changes slightly over the time, so it occupies an important place in comet cosmogony. From fig. 3 it can be seen that the value  $T_{Jup}$  remains within 2.5 and 3 which points to strict relationship between the comet and Jupiter.



**Fig. 4. Dependence of inclination and eccentricity upon the time**

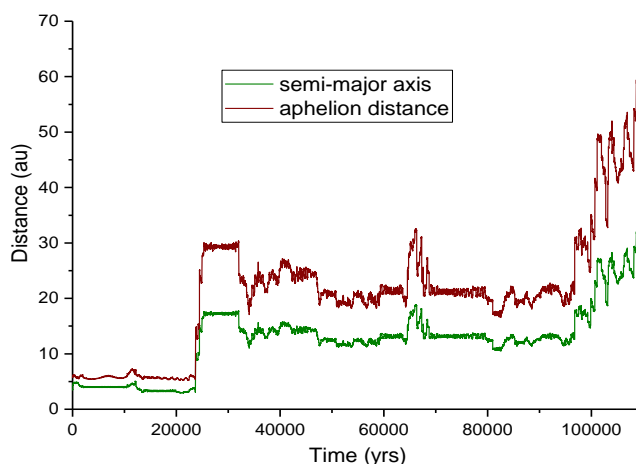
As shown by fig. 4, inclination of the cometary orbit changes with the eccentricity thus making performance of the Lidov–Kozai mechanism [8]:

$$L_z = \sqrt{1 - e^2} \cos i$$

Fig. 5 shows dynamic change of values  $a$  and  $q$  over long time integration into the past. As we may see on the picture the comet 67P/C-G probably originates in trans-Neptunian region. Then trough passing planetary region its orbit becomes “smaller” during close approaches with giant planets.

## Discussion

Results of the calculations suggest that the comet 67P/C-G was captured by Jupiter during crossing the plane of Jupiter orbit. Thereafter the comet had been in strong relation to the planet, as evidenced by location of its orbital nodes and values of Tisserand's constant. Orbital evolution of 67P/C-G is chaotic. Dynamical lifetime of 67P is about ~100 000 years.



**Fig. 5. Dependence of semi-major axis (bottom curve) and aphelion distance (Q, upper curve) upon the time**

This is shorter than the median dynamical lifetime of 450 000 years calculated by Levison & Duncan [9] for short-period comets. According to our calculations, more than 20000 years ago the comet was the object of the Kuiper belt.

## References

1. Tubiana C. et al. "67P/Churyumov-Gerasimenko at large heliocentric distance", *Astronomy & Astrophysics*, 2011, Vol. 527, p. A113.
2. Maquet L. "The recent dynamical history of comet 67P/Churyumov-Gerasimenko", *Astronomy & Astrophysics*, 2015, Vol. 579, p. A78.
3. Guzzo M., Lega E. "A study of the past dynamics of comet 67P/Churyumov-Gerasimenko with fast Lyapunov indicators", *Astronomy & Astrophysics*, 2015, Vol. 579, p. A79.

4. Groussin O. et al. "The long-term evolution and initial size of comets 46P/Wirtanen and 67P/Churyumov–Gerasimenko", Monthly Notices of the Royal Astronomical Society, 2007, Vol. 376, p. 1399-1406.
5. Krolkowska M. "67p/Churyumov-Gerasimenko-potential target for the ROSETTA mission", Acta Astronomica, 2003, Vol. 53, pp. 195-209.
6. Chambers J. E. "A hybrid symplectic integrator that permits close encounters between massive bodies", Monthly Notices of the Royal Astronomical Society, 1999, Vol. 304, p. 793-799.
7. Marsden B. G., Sekanina Z., Yeomans D. K. "Comets and nongravitational forces.V", The Astronomical Journal, 1973, Vol. 78, p. 211-225.
8. Kozai Y. "Secular perturbations of asteroids with high inclination and eccentricity", The Astronomical Journal, 1962, Vol. 67, pp. 591-598.
9. Levison H. F., Duncan M. J. "The long-term dynamical behavior of short-period comets", Icarus, 1994, Vol. 108, pp. 18-36.

## **"SATPAG" SPECIAL SYSTEM OF INFORMATION TRANSFER TO SEISMIC DISASTER AREAS**

**<sup>1</sup>Ali Abbasov, <sup>2</sup>Elchin Khalilov**

*<sup>1</sup>National Academy of Sciences of Azerbaijan,*

*<sup>2</sup>Global Network for the Forecasting of Earthquakes, Baku, Azerbaijan*

*pr.dr.abbasov@gmail.com,*

*e-mail: prof.khalilov@gmail.com*

### **Abstract**

The invention consists in the following: a receiving device (RD) receives its coordinates from a satellite navigation system (e.g. GPS) and uses the coordinates' values (longitude and latitude) to generate its own personal activation code and data reception format (information decoding algorithm) at a certain standard radio frequency. To communicate information to specified users depending on their location, first, the emergency area and its separate parts are selected and narrowed for information transmission; then, a matrix is formed within the area of the selected territory, each cell of which has its coordinates, followed by generation of information packets intended for users within the selected area, with data transfer activation code based on the coordinates of each individual cell of the matrix and identical to the user's RD activation code, attached to the beginning of these packets.

**Keywords:** "SatPag" system, seismic disaster areas, emergency management.

## **INTRODUCTION**

Recent large-scale natural catastrophes such as devastating earthquakes, tsunamis and floods have demonstrated that failures in regular and special communication systems are one of the most pressing and topical problems of emergency management and search and rescue operations in the areas affected by large-scale natural disasters. This is due to the collapse of receiving and transmitting cellular communication systems, transmitters and other systems of information transfer and receipt. Effective coordination of activity of all involved public administration systems, rescue services, ministries and agencies during both emergency situations caused by natural and man-made disasters and response efforts largely depends on accurate and failure-free operation of communication systems and telecommunication resources. In the vast majority of cases, people in disaster areas during large-scale natural disasters find themselves isolated from outside information and have no idea what action to take: whether to wait for on-site assistance; or to move in any direction from the place where danger is expected; or which routes might be the most secure; where and when to wait for humanitarian aid, etc. Not only does that complicate the work of rescue services but also leads to panic and chaos among the people caught in disaster areas, multiplying thus the adverse effects of natural disasters.

## **METHODOLOGY**

The invention consists in the following: a receiving device (RD) receives its coordinates from a satellite navigation system (e.g. GPS) and uses the coordinates' values (longitude and latitude) to generate its own personal activation code and data reception format (information decoding algorithm) at a certain standard radio frequency. To communicate information to specified users depending on their location, first, the emergency area and its separate parts are selected and narrowed for information transmission; then, a matrix is formed within the area of the selected territory, each cell of which has its coordinates, followed by generation of information packets intended for users within the selected area, with data transfer activation code based on the coordinates of each individual cell of the matrix and identical to the user's RD activation code, attached to the beginning of these packets. After that, the information packet is transmitted for all cells of the matrix from a ground station through one or more radio broadcasting satellites whose range covers the emergency area. Radio broadcasting satellites transmit information packets at a standard radio frequency in the format based on the values of RD coordinates.

On receiving the activation code corresponding to the personal activation code generated by it, RD is enabled and starts receiving and recording transmitted information in the appropriate format. Information can be of any character: text, audio address, video, graphic image, etc. A diagram of the information reception and transmission system is shown in Fig.1.

The proposed method of information reception and transmission and the system for its implementation allows use of special very simple RDs such as pagers, cell phones, computers and other devices with special built-in modules for information reception to receive targeted information via standard radio broadcast satellites; moreover, the information is to be received only by the user for whom it is intended, depending on his/her location. If a user is outside the zone for which the information is intended, their RD is not activated and ignores this information, Fig. 2.

**The proposed invention is illustrated by the following examples:**

1. RD receives the coordinates of its location from GPS satellites and generates its ID code (activation and information reception code) using the received coordinates, for example: RD coordinates are:  $46^{\circ}57'32''$  (north latitude is given in the code as the last digit of the coordinate of latitude, for instance, as fig. 1) and  $42^{\circ}38'21''$  (east longitude is given in the code as the last digit of the coordinates of longitude, for instance, as figure 1), generating there by the following code:  $465732\underline{1}423821\underline{1}$ .

If it is south latitude, figure 2 is shown at the end of the coordinates of latitude, for example, and in case of west longitude, figure 2 is shown at the end of the coordinates of longitude as well, generating there by the following code:  $465732\underline{2}423821\underline{2}$ . The coordinates' precision can be at any level. Thus a code is generated which contains complete information about the RD coordinates.

2. When information is transmitted to the given RD, the operator sends digital information in the form of text, sound or image (for example, maps showing a moving direction or destination point); a digital code with RD coordinates such as:  $465732\underline{1}423821\underline{1}$  is sent at the beginning of the transmitted signal.

Prior to receiving a code corresponding to RD's own ID code, RD is in a "sleeping" mode with minimal power consumption. When the activation code is received, the receiving module activates RD and enables data reception and recording and RD issues a signal (sound, light, vibration, or any combination of signals).

3. If the operator of the transmitting station which sends information packets does not know the exact coordinates of the RD location but might be aware of the approximate square where RD is located, he/she marks boundaries of the square on to which information is transmitted, for example: between  $46^{\circ}57'32''$  and  $46^{\circ}57'37''$  north latitude and between  $42^{\circ}38'21''$  and  $42^{\circ}38'25''$  east longitude. The transmitter generates a

matrix of cells equal to, for example, 1 second, and transmits the information, scanning by turns all cells of the matrix, and RD which is within the range of this square receives its activation code and is enabled for data reception. The information sent from the satellite will be received by RD. After the information transmission is over, the operator from the satellite transmits the “end of transmission” code, RD is deactivated and goes into stand by mode (“sleeping” mode).

4. If the operator of the transmitting station knows in what area RD is, they can transmit information on to a matrix with any configuration of boundaries. If the information is to be communicated by the operator to a group of people located within the presumed sector, the operator selects the sector of the emergency area, and during signal transmission based on scanning of the cells of the matrix, all RDs located within the mentioned sector of the emergency area will receive the necessary information.

RDs can be of different levels of complexity and purpose. For example, there can be four (or more) basic types of RD:

- **General usage RDs.** At the end of the regular ID code of those RDs, for example, 15 or a different number of 0 (or another) digits are placed.

For example: 46573214238211

These RDs receive information intended for all RDs in the covered area.

- **Collective RDs** with a specific 15-digit code after the regular code, for example: 46573214238211**454126319756893**

These RDs can operate in two modes and receive information simultaneously in the standard and special modes or, according to the owner's wish, in one of them. For these RDs, information can be sent concerning only specific RD owners located in the covered area and possessing this code, for example, only rescuers in an emergency area in order to separate the reactions from those of others. Each team can have its own code to discretely manage various structures - rescuers, police, doctors, military.

- **Individual RDs.** Individual RDs are based on the same principles as the special ones and may have an individual 15-digit code after the regular code. They can be intended for members of the government, heads of rescue operations, etc.

- **Special multichannel RDs** can have several receiving channels and simultaneously receive information on each channel separately.

This may be needed for simultaneous transfer of a large flow of varied information, for example, if RD is used for remote control of complex hardware. For

instance, control of some complex systems operated centrally may be lost due to destruction of their control system or communications in the emergency area. It, for example, could be nuclear power plants, refineries, major fuel terminals, hydraulic facilities, dams, etc. For this occasion, standalone RD mini control units can be installed to perform specific commands for electronic actuators such as electronic valves blocking oil and gas pipe lines, water intake gates at dams and hydraulic facilities, etc. In this case, each RD communication channel can be used to independently control different modules of the managed object. Communications control centers (CCC) which generate and send information packets to disaster areas should be preferably deployed in the safest regions, possibly with several duplicate centers. CCC can use the Internet, mobile connection and special facilities for communication with governments; state emergency management agencies of different countries; the UN; forecast centers for various natural disasters-tsunami, tornado, storms, earthquakes, volcanic eruptions, etc. The incoming information intended for transmission to an emergency zone should contain the coordinates of the disaster area, the main text and may include other applications such as maps, charts, tables, etc. This information is forwarded by CCC operators to the transmitting station and further to a communications satellite, which broadcasts this information in the area covering the emergency territory. Depending on the location of the disaster area different communication satellites can be used.

## **RESULTS**

Special means of communication such as satellite phones and communications systems cannot be available today to the wide sections of the population and most government officials. Therefore, a fundamentally new technical solution is needed to effectively provide the general public and civil servants who find themselves in large-scale natural disaster areas, with targeted information. This can be said about the International System "SatPag" (Eurasian Patent №017487: "Method of receiving and transmitting information", authors: A.M. Abbasov, E.N. Khalilov, 2011), a basically new type of one-way information communication. Unlike the conventional paging, information transfer in the "SatPag" system includes selective radio transmission of the targeted information to either individuals, small groups or unlimited number of people in disaster zones, depending on their location. A special activation code enables signal reception in only those SatPag receivers (satpagers) for which the information is intended; the rest do not react. No dedicated channels for pagers are used; there is a direct radio broadcast on the air, which allows unlimited numbers of people to be subscribers of this international network without connecting to it. Fig. 3-7. shows the full cycle of the SatPag system

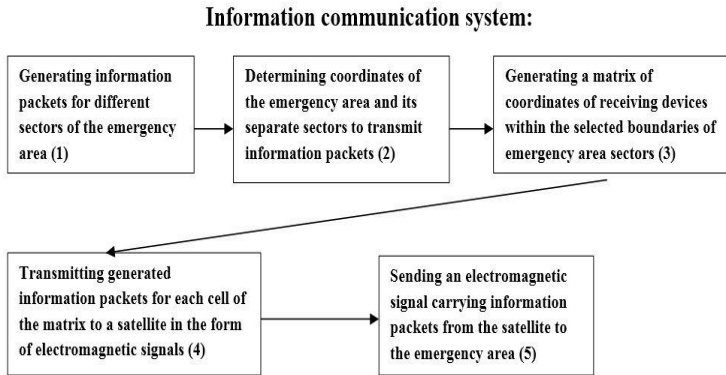


Fig. 1. Diagram of the information reception and transmission system of “SatPag”.

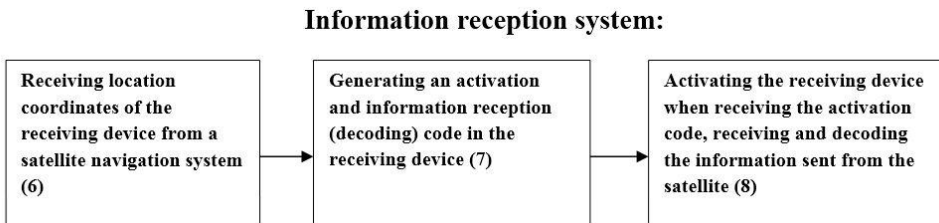
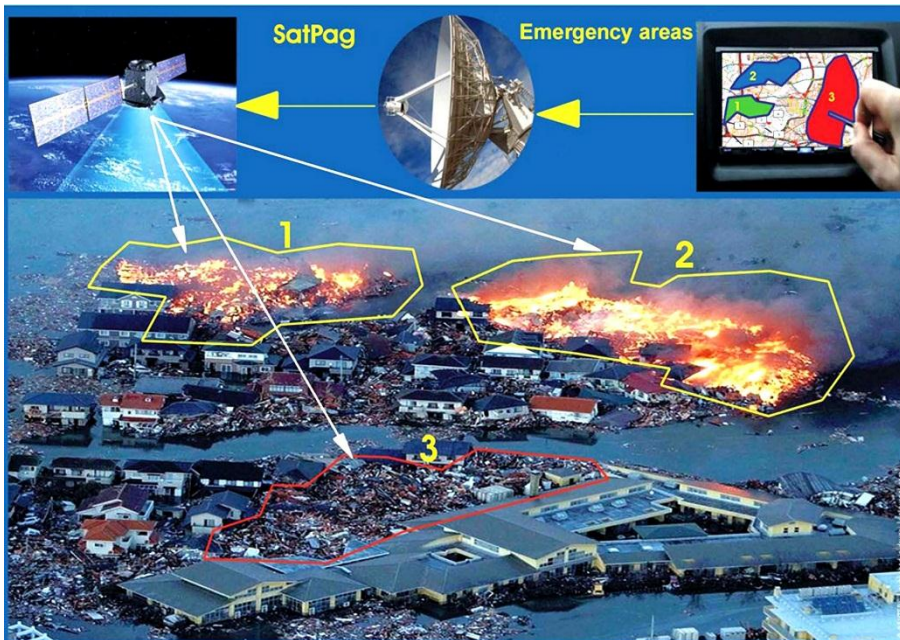


Fig. 2. Diagram of the information reception system of “SatPag”.

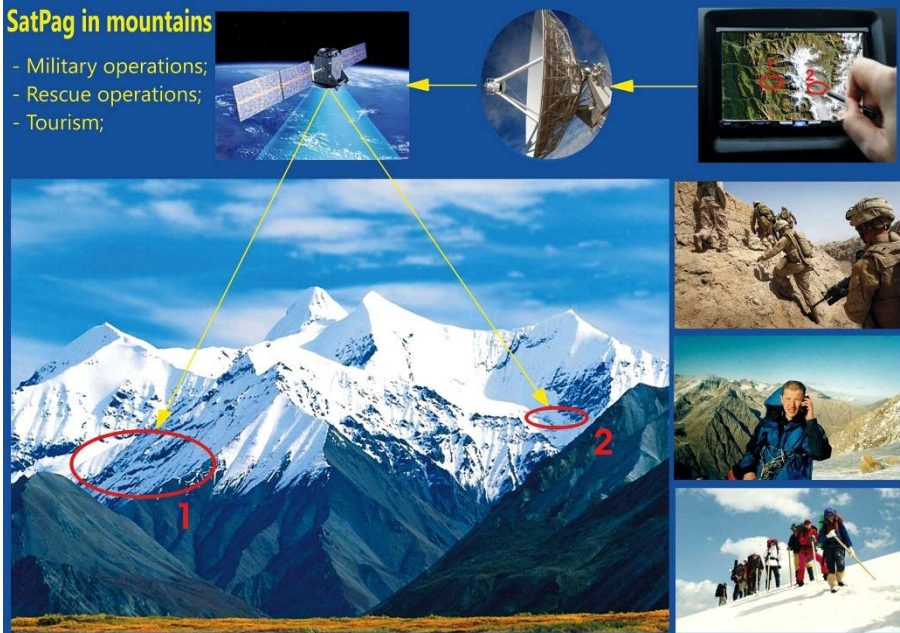


Fig. 3. Using SatPag Professional, information can be sent to different state services in emergency zone.





**Fig. 4. Using SatPag Professional, information can be sent to emergency zones.**



**Fig. 5. Using SatPag Professional, information can be sent to emergency zones mountains.**



**Fig. 6. Using SatPag Professional, information can be sent for transport management.**



**Fig. 7. Using SatPag Professional, information can be sent for themanagement of strategic objects**

## **CONCLUSION**

The “Satpag” System Can Be Used To Transmit Information To People In Natural Disaster Areas, Rescue Services, Civil Servants, For Military Command, Rescue Teams In Mountains, Etc.

## **References**

1. M. Abbasov and E.N. Khalilov, “Method of transmit-ting and receiving information,” WIPO, International Application No.: PCT/AZ2011/000011, Geneva, 2013, Pub. No.: WO/2013/023255
2. A.M. Abbasov and E.N. Khalilov, “Method of transmit-ting and receiving information,” Eurasian Patent N 017487, EAPO, Moscow, 2012.

## **EARTH SCIENCES, ECOLOGY**

### **THE INFLUENCE OF GEODYNAMIC PROCESSES ON THE SAFETY OF INDUSTRIAL AND CIVIL FACILITIES OF AZERBAIJAN**

**<sup>1</sup>Elchin Khalilov, <sup>2</sup>Wang Lanmin, <sup>3</sup>Lala Khalilova**

*<sup>1</sup>Global Network for the Forecasting of Earthquakes,*

*<sup>2</sup>China Earthquake Administration, <sup>3</sup>Lanzhou Institute of Seismology*

e-mail: prof.khalilov@gmail.com

#### **Abstract**

The influence of geodynamic processes on the safety of main pipelines and other industrial facilities, as well as residential buildings in the territory of Azerbaijan have been considered. Based on analysis of recordings of tectonic waves before the earthquakes in Iran, there was made the assumption about their possible provocation of numerous landslides in Azerbaijan in April-May 2010. There was proposed the concept about the possible effect of tectonic waves on large-scale deformation of the earth's surface and damage to main pipelines, technical infrastructure of the oil and gas industry, and civilian objects. The authors compiled a map of potentially dangerous sites of possible damage to the main oil pipelines and gas pipelines of Azerbaijan.

**Keywords:** geodynamical processes, gravitational precursors, tectonic waves, geotechnics.

#### **INTRODUCTION**

The influence of geodynamic processes on the safety of pipelines and other objects of the oil and gas industry was considered in the works of many authors [1-8]. The task of research: studying the influence of modern geodynamic processes on the safety of civil and industrial facilities on example of Azerbaijan. Considering the geodynamic factors, many researchers divide them into two types: technogenic and natural. To technogenic factors refers the subsidence of the earth's surface in the areas of exploitation of oil and gas fields, as well as in zones of coal mines [9]. To the natural geodynamic

factors refer first of all, the deformations of the layers and the earth's surface in the zones of active tectonic faults.

A numerous landslides in 10 regions of Azerbaijan can be considered as a unique geological event: in the north, south, west, east and in the central part of the country. As a result of landslides, many houses, roads and bridges were destroyed, and there were also victims among the population [11].

Analysis of records of tectonic waves (stress waves or deformation waves) with the help of ATROPATENA geophysical stations in Baku (Azerbaijan) showed that the tectonic waves of great length were emitted from the hypocenters of Iran earthquakes with magnitudes from M4.6 to M5.1 a few days before the earthquakes during April-May 2010. These waves, according to the authors, led to large-scale deformation of the Earth's surface throughout Azerbaijan, which caused numerous landslides.

## **INVESTIGATION OF DAMAGES OF INDUSTRIAL AND CIVIL OBJECTS AS RESULT OF TECTONIC DEFORMATIONS**

### *A. Damage to main pipelines*

Analysis of the statistical data of the causes of accidents that occurred on the main gas pipelines of Russia showed that one of the factors that influence on the damage of gas pipelines are the geodynamic processes occurring in the pipeline passage zones [1].

It turned out that there are modern superintense deformations of the earth's surface with speeds up to 50-70 mm per year which are confined to tectonic disturbance zones (faults of various types and orders) [8]. At the same time, the most paradoxical result is that the maximum intensity of geodynamic anomalies is observed in the zones of platform, aseismic faults. In our opinion, the paradoxical situation described above is connected with the fact that the tectonic deformations are not directly connected with the geodynamic processes of the territories through which the pipelines pass. The main reason of such tectonic deformations can be the tectonic waves, which are emitted before and after strong earthquakes out of their hypocenters. The results of our researches show that the tectonic waves can pass the huge distances of up to 10,000 km keeping a high level of energy and causing the deformation of the earth's layers and the earth's surface [12-16].

A number of scientists [1-2] obtained the convincing data about the large scale and high level of influence of the geodynamic factor on the objects of the oil and gas complex. In the zones of manifestation of modern intensive deformations, there are periodic disruptions of pipelines and damage to the wells, followed by their decommissioning. Thus, it becomes obvious that the technical condition of oil and gas facilities in the fields largely depends on the level of the current stress-strain condition

of the earth's interior. Therefore, the geodynamic factor must be taken into account along with other factors at the design stage of wells and pipelines [8]. At the same time, the taking into account the factors of anomalous geodynamics of subsurface allows optimal placing of wells and pipeline systems and applying the preventive measures to preclude emergencies and reduce damage.

According to A.A. Panzhin and I.L. Ozornin [17], a practical example of the confinement of pipeline ruptures to places where they intersect tectonic disturbances is the Fedorov oil field in Russia.

The development and involvement of the oil and gas fields in the Barents and Pechora seas without taking into account the geo-mechanical processes can lead to the formation of conditions of the arising and realization of destructive geodynamic phenomena [18]: subsidence, landslides, earthquakes.

### *B. Destruction of residential buildings*

The unusually high activity level of natural disasters started to manifest itself across Azerbaijan from as early as the beginning of April 2010. April 5, 2010 saw a massive landslide on the Agsu Pass of the Shamakhy rayon, Azerbaijan. The ground sank along a nearly 30 meter long section of the Baku-Shamakhy-Yevlakh highway, significantly hindering road traffic. On April 10, 2010, largescale landslides occurred in the mountain villages Urwa and Gulazi of the Gusar rayon of Azerbaijan, resulting in destruction of homes and extensive damage. A massive landslide triggered took place in the Tovuz rayon of Azerbaijan on 27 April 2010; an entire private house sank underground, leaving five family members dead. Immediately thereafter, information about landslides and land subsidence started to arrive from different regions of Azerbaijan. A study of the development of landslide processes in Azerbaijan showed that from 05 April to May 03, 2010 Azerbaijan witnessed one of the world's unique events, that is, simultaneous occurrence of large-scale landslides in ten regions of Azerbaijan: the Shamakhy, Balakan, Quba, Gusar, Tovuz, Dashkesan, Goygol, Astara, Ismailly, and Lankaran rayons [11]. These landslides destroyed many private houses and roads, causing great material damage. The situation's peculiarity owes to the fact that these areas are situated at the opposite ends of Azerbaijan, that is, in the north, south, west and north-east. Such a simultaneous large-scale manifestation of landslide phenomena within a vast territory that stretches across the whole of Azerbaijan can hardly be explained by only the heavy precipitation that falls there in large amounts every spring. Rather, intense large-scale tectonic processes in the Caucasus triggered the landslides. On 06 May 2010, a very large landslide took place in the Muganli village of the Shamakhy rayon of Azerbaijan (approximately 110 kilometers west of Baku) as a result of the continuing precipitation, leaving 15 of the village's 180 houses in hazardous

condition and forcing residents of five houses to be resettled. The roads leading to the village were blocked, and sown areas and orchards suffered great damage.



**Fig.1. The regions of Azerbaijan: 1- Shamakhy; 2 – Gusar; 3 – Tovuz; 4 - Balakan; 5 – Quba; 6 – Dashkesan; 7 - Goygol; 8 - Astara; 9 – Ismailly; 10 - Lankaran**

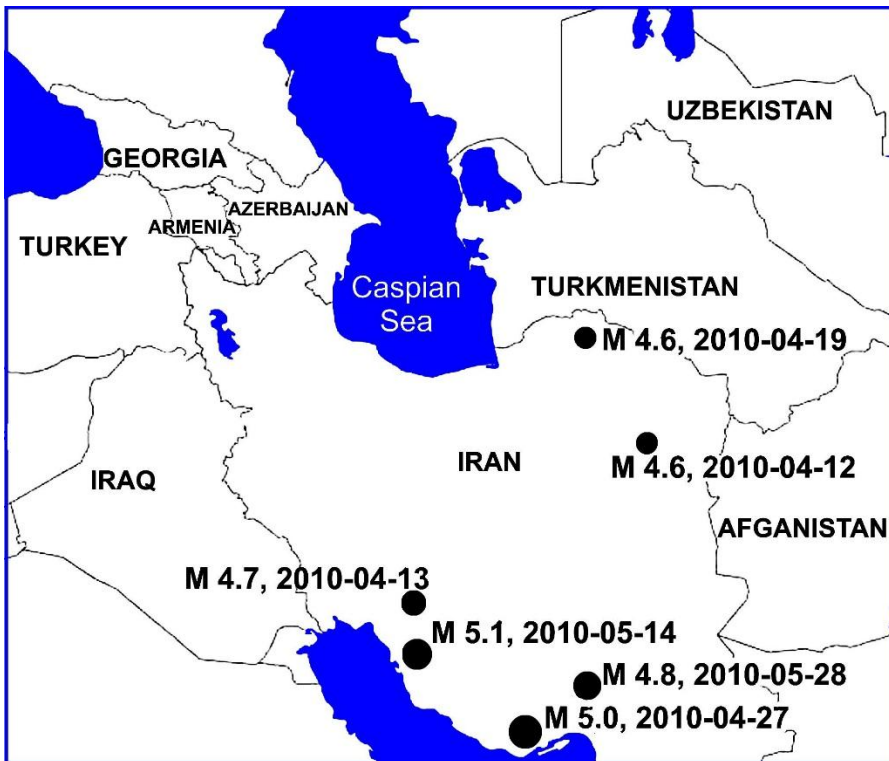
## **METHODOLOGY**

The authors investigated the correlation between strong earthquakes, registration of tectonic waves and landslide phenomena in the territory of Azerbaijan. During the investigation the records of gravitational anomalies recorded by the earthquake forecasting station ATROPATENA-AZ2, located in Baku in the Institute of Forecasting and Studying the Earthquakes, were studied.

### ***Analysis of the seismic situation***

To study the possible influence of tectonic waves on the occurrence of numerous landslides throughout the territory of Azerbaijan in April-May 2010, we compiled a map of earthquakes with a magnitude  $M > 4.5$  for the territory of the Caspian-Black Sea region, the western part of Central Asia, Iran and the surrounding regions, Fig. 2.

The map shows the earthquakes with  $M > 4.5$ , which occurred on this territory during April-May 2010. Analysis of seismic activity for the previous period of time showed that is high level of seismic activity for this region. To determine the possible influence of tectonic waves, which were before the earthquakes in Iran, on the excitation of many landslides in Azerbaijan, there was analyzed the gravitogram record of ATROPATENA earthquake forecasting stations.



**Fig. 2.** Map of earthquakes with  $M > 4.5$  during April-May 2010, the Caspian-Black Sea region, the western part of Central Asia, Iran and the surrounding regions.

## MEASUREMENT RESULTS

### *A. Tectonic waves registration and their parameters*

A study of precursors of strong earthquakes and subsequent wave tectonic studies showed that 3-10 days before strong and medium earthquakes the special tectonic waves (stress waves) are emitted from the region of hypocenters of earthquakes [12-14]. These waves are significantly different from the seismic waves with their parameters, and they cause slow deformations of the seams and surfaces of the Earth. For example, the period of tectonic waves can vary within wide limits from several hours (high-frequency waves)



to 20 days (low-frequency waves). The speed of tectonic waves on the continents is on average 30-60 km/h, whereas in the oceanic crust it is 100-150 km/h [15]. The length of tectonic waves can be from 80-100 km to 1500 km. The registration of tectonic waves has begun for the first time since 2008 with the help of ATROPATENA earthquake forecasting stations, which were located in Yogyakarta (Indonesia), Islamabad (Pakistan), Baku (Azerbaijan), Istanbul (Turkey) and Kiev (Ukraine). The physical principle of these stations was based on the measurement of three-dimensional variations of the gravitational field and described in detail in the work [16]. The records of the ATROPATENA station are called gravitograms.

### *B. Physical model*

It is well known from the theory of rock mechanics that at deformation of a mountain mass consisting of layers with different physical and mechanical properties, the maximum stresses are observed at the boundary between layers mechanical characteristics of which have the biggest differences, as shown in fig. 4.

Theoretical and practical studies of tectonic waves have been conducted by some scientists over the past 50 years [12-15, 19-22]. Tectonic wave, from the point of view of external manifestation, can be compared with a seismic wave. It, as well as the seismic wave, has the components - P wave and S wave (shown in fig. 4.), and, in the opinion of the authors, the surface waves in analogy with the Love and Rayleigh waves. The sedimentary layer of the earth's crust of Azerbaijan is composed mainly of clays and sandstones, as well as tuffs. Thus, with the passage of tectonic waves, the maximum mechanical stresses and deformations concentrate on the boundaries of these layers. As a result of the studies, the authors established a temporary link between a series of earthquakes with a magnitude of 4.6 to 5.1, which occurred in Iran during April-May 2010 and large landslides on the territory of Azerbaijan. The authors drew up a map of potentially hazardous areas for industrial facilities, main fuel and energy communications and railways. In the processes of compression and stretching of soil during the passing of tectonic waves, the critical tangential stresses arise on the horizontal boundaries between rocks with different density and structure. When the stress exceeds the ultimate strength, a break occurs at the boundary of the layers with different physical and mechanical properties, which leads to a shift of the overlying layer relative to the underlying one. Taking into account the big length of tectonic waves (from a few hundreds kilometers to more thousand of kilometers), with the of a large number of precipitations and the presence of clay layers, tectonic waves provoke landslides and avalanches, large deformations and the formation of large cracks.

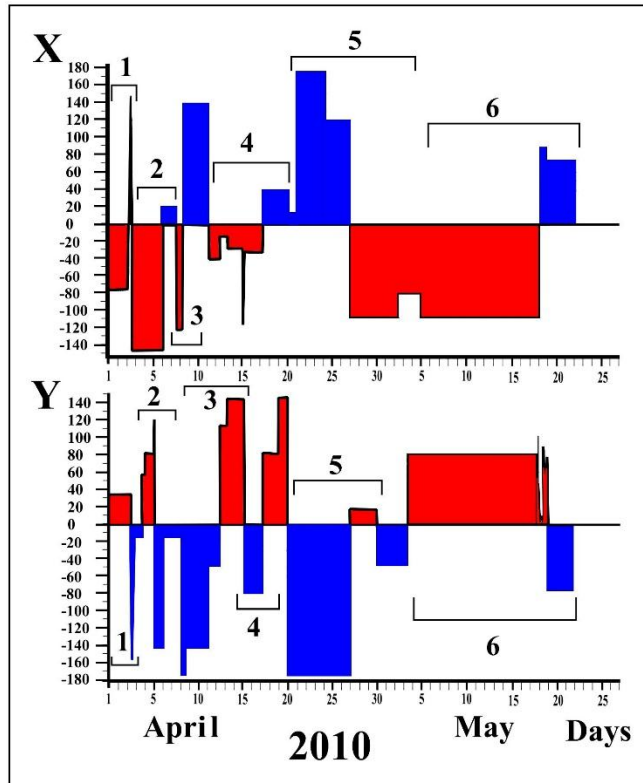


Fig. 3. The gravigram recorded by the ATROPATENA station in the period from 1 April to 25 May, 2010; X is record of the first channel; Y is record of the second channel. 1-6 is the designation of gravitational anomalies reflecting the tectonic waves

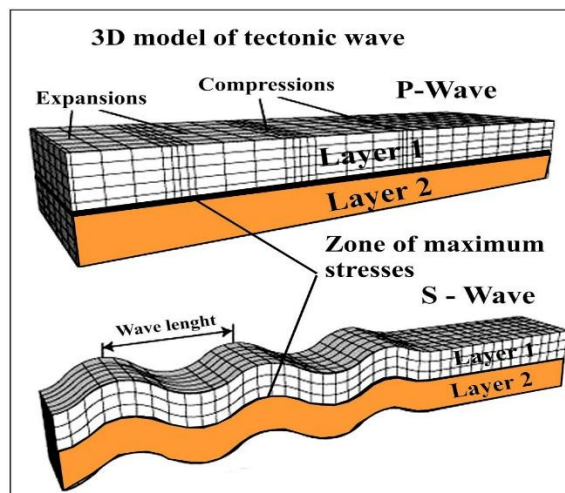


Fig. 4. Diagram of a three-dimensional model of a tectonic wave

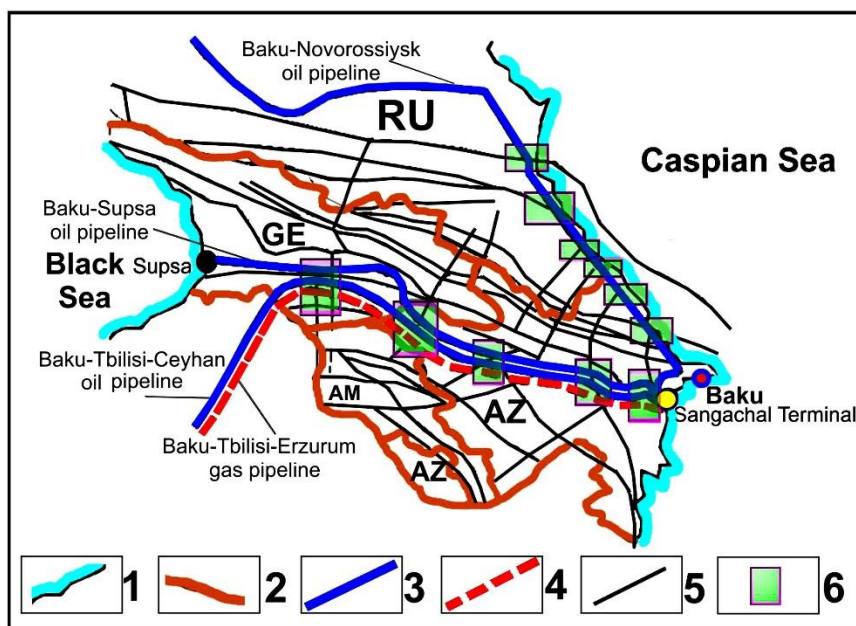
As a result, there occurs the destruction of civil and industrial facilities located on the surface of the Earth and underground: buildings, hydraulic structures, tunnels, railways and highways, bridges, main pipelines, underground optical and power cables, power lines. As a result of the studies, the authors established a temporary link between a series of earthquakes with a magnitude of 4.6 to 5.1, which occurred in Iran during April-May 2010 and large landslides on the territory of Azerbaijan. The authors drew up a map of potentially hazardous areas for industrial facilities, main fuel and energy communications and railways. In the processes of compression and stretching of soil during the passing of tectonic waves, the critical tangential stresses arise on the horizontal boundaries between rocks with different density and structure. When the stress exceeds the ultimate strength, a break occurs at the boundary of the layers with different physical and mechanical properties, which leads to a shift of the overlying layer relative to the underlying one. Taking into account the big length of tectonic waves, with a large number of precipitations and the presence of clay layers, the tectonic waves provoke landslides and avalanches, large deformations and the formation of large cracks. As a result, there occurs the destruction of civil and industrial facilities located on the surface of the Earth and underground: buildings, hydraulic structures, tunnels, railways and highways, bridges, main pipelines, underground optical and power cables, power lines. Taking into account that in many regions of Azerbaijan, the upper layers of the earth consist of clays, the numerous precipitations during spring rains and floods lead to dissolution and decompaction of clays, while the passage of a tectonic wave is a trigger mechanism leading to the beginning of landslides. The described mechanism can explain the reason of the unusual phenomenon - simultaneous numerous landslides throughout the territory of Azerbaijan in April-May 2010.

### *C. Mapping of zones of geodynamic hazard*

In recent years, due to the active development of the infrastructure of the oil and gas industry in a number of countries located in seismically active areas, the great attention is paid to forecasting of potentially dangerous geodynamic zones along the main oil pipelines and gas pipelines, as well as terminals and other infrastructure facilities of the fuel and energy complex. For example, in the works [13] there is described the experience of creating maps of potentially dangerous geodynamic zones in the area of crossing the main pipelines and active tectonic faults. Using the accumulated world experience, as well as own research results, the authors compiled a map of potentially dangerous sites of possible damage to the main oil pipelines and gas pipelines of Azerbaijan, fig. 5.

On the map fig. 5 the sites of the main oil pipelines crossing were identified: Baku-Novorossiysk, Baku-Supsa and Baku-Tbilisi-Ceyhan and the Baku-Tbilisi-Erzurum gas

pipeline with active tectonic faults of the Caucasus. These sites are identified by the authors as potentially dangerous areas of possible mechanical damage.



**Fig. 5. A map of potentially dangerous sites of possible damage to the main oil pipelines and gas pipelines of Azerbaijan. 1 is a coastline of the Caspian and Black Seas; 2 is state borders of countries; 3 is main oil pipelines; 4 is main gas pipelines; 5 is active tectonic faults; 6 is potentially hazardous areas of possible damage to main pipelines**

## CONCLUSION

The authors came to the conclusion that in the period of April-May 2010, as a result of large-scale deformation processes near the surface of the earth's crust, there were large landslides in the north-south and west-east, as well as in the central part of Azerbaijan. These deformations were caused by tectonic waves emitted by the hypocenters of moderate intensity earthquakes from 4.6 to 5.1, which occurred on the territory of Iran. Tectonic waves were recorded before earthquakes (earthquake precursors) and after earthquakes (secondary tectonic waves). The authors compiled a map of potentially dangerous sites of possible damage to the main oil pipelines and gas pipelines of Azerbaijan.

## References

1. N.A. Kasyanova and Yu.O. Kuzmin, "Modern anomalous geodynamics of subsoil and its impact on the objects of the oil and gas complex," *Geoinformmark*, Moscow, 1996, 55 p.
2. N.A. Kasyanova, *Ecological risks and geodynamics*, Scientific world, Moscow, 2003, 332 p.
3. N.N. Melnikov and A.I. Kalashnik, "Geodynamic risks of development of oil and gas deposits in the Barents Region and pipeline transportation of hydrocarbon raw materials," *Murman shelf Info*, Resource Center, No. 4, 2008, p.13-17.
4. S.P. Lebedich, V.L. Dvornikov and E.I. Selyukov, O.A. Cherepanov, Y.S. Ryaboshtan, "Geodynamic activity and safe operation of main oil and gas pipelines," *Gorny Vestnik*, No. 4, 1998.
5. Y.S. Ryaboshtan and E.I. Selyukov, "Influence of the rotational stress field on the stability of territories and engineering structures," *Proceedings of the scientific and technical conference "Seismic stability of large transport structures in complex engineering and geological conditions"*, Moscow, ZNIIS, 1999, December 1-4, 1998,
6. Y.S. Ryaboshtan and E.I. Selyukov, "Modern instability of the lithosphere and security of pipeline communications and infrastructures," *Scientific and Technical Journal, Oil and Gas Business*, vol. 1, 2003.
7. S.V. Savonin, A.V. Moskalenko and A.V. Tünder. "Analysis of the main causes of accidents that occurred on the main gas pipelines," *Oil and Gas of Siberia*, vol. 4 (21), 2015.
8. Y.O. Kuzmin, "Modern superintensive deformations of the earth's surface in zones of platform faults," *Geological study and use of mineral resources: scientific-technical collection*, *Theinformmark*, Moscow, vol. 4, 1996, pp.43-53.
9. N.N. Melnikov, A.I. Kalashnik and N.A. Kalashnik, "Technogenic geodynamic processes in the development of oil and gas deposits in the Barents Sea shelf," *Bulletin of MSTU*, volume 12, N4, 2009, pp. 601-608.
10. G.A. Sobolev, A. A. Lyubushin and N. A. Zakrjevskaya, "Asymmetric impulses, periodicity and synchronization of low-frequency microseisms," *Volcanology and seismology*, vol. 2, 2008, pp. 135-152.
11. E.N. Khalilov, "The first report of IC GCGE GEOCHANGE, "Global changes of the environment: threatening the progress of civilization". *GEOCHANGE: Problems of Global Changes of the Geological Environment*. Vol.1, London, 2010, pp.102-103.
12. V.E. Khain, E. N. and Khalilov, "Tideless variations of gravity before strong distant earthquakes," *Science Without Borders*, vol. 2, ICSD/IAS H&E, Innsbruck, 2006, pp. 319-339.
13. E.N. Khalilov, "About influence of geodynamic processes on the results of measurements of Cavendish balance," *Science Without Borders*, vol. 3, Innsbruck, 2009, pp. 398-410.
14. E.N. Khalilov, "Earthquake prediction method and device for the implementation thereof," *World Intellectual Property Organization (WIPO)*, Geneva. 2013, WO 2013/096997 Eurasian Patent 018373.
15. E.N. Khalilov, V. I. Starostenko, A. V. Kendzera, A. Mubarak, M. Qaisar and R. Sjamsinarsi, "Global gravitational effects before and after strong M8.9 JAPAN earthquake of March 11, 2011," *Proc. Int. Congress. Natural Cataclysms and Global Problems of the Modern Civilization*, Istanbul, Sept. 2011, pp. 57-69
16. E.N. Khalilov, "Global network of forecasting of earthquakes. New technology and new philosophy," *London. SWB*, 2009, 65 p.

17. A.A. Panzhin and Ozornin I.L. Investigation of geodynamic activity of the area of the field GRIBNOYE. Georesources. Geoenergetics. Geopolitics. The electronic scientific journal. Release: 2 (2), 2010.
18. A.I. Kalashnik, Geodynamic and economic risks of offshore oil and gas exploration in the Barents Region. Tr. 8th International Forum TEC. St. Petersburg, P. 388-392, 2008.
19. W.H. Elsasser, "Convection and stress propagation in the upper mantle," Appl. Modern Phys. Earth Planet. Inter. N.Y., Wiley, 1969, pp. 223-246.
20. F.K. Lehner, V.C. Li and J. R. Rice, "Stress diffusion along rupturing boundaries," J. Geophys. Res. Vol. 86, N B1, 1981, pp. 6155-6169.
21. E.A. Gorbunova and S. I. Sherman, "Slow deformation waves in the lithosphere: Registration, parameters, and geodynamic analysis (Central Asia)," Russian Journal of Pacific Geology, vol.6, N 1, 2012, pp. 13–20.
22. V.I. Keilis-Borok, and P. N. Shebalin, "Dynamics of the lithosphere and earthquake prediction," Physics of the Earth and Planetary, Interiors, vol. 111, 1999, pp. 179-327.

## **EARTHQUAKE AND TSUNAMI - CHALLENGES FOR THE APPLICATION ORIENTED EXTENDED VIEW**

**<sup>1</sup>Khalilov E., <sup>2</sup>Kofler W.**

<sup>1</sup>*International Academy of Science H&E, AS (Baku, Azerbaijan),*

<sup>2</sup>*International Academy of Science H&E (Innsbruck, Moscow),*

*prof.khalilov@ias-as.org,*

*walter.kofler@ias-he.com*

### **Summary**

Earthquakes and tsunami cause often serious bodily burdens up to death. Geophysics deals with the related gravitational processes. Therefore these related geophysical models have to be compatible with the comprehensive health related model of the Extended View. General Relativity Theory is the fundamental theory for gravitation. Therefore it is to expect that the GRT is an indispensable tool for the prediction of the effects of earthquakes and tsunamis. But this is not the case. The formulas of the GRT cause often incompatibilities with the phenomena in reality and with predictions thanks to the commonly used formulas by geophysicists. They are based especially on Newton's formulas. For that reason formulas of geophysics and of the GRT are incompatible.

Therefore the relevance of these geophysical processes is a challenge for the pretention of the EV, to offer a really comprehensive model for any health related interactions. The compatibility of theories which seem incompatible can be proved

thanks to the steps which Einstein has developed for his technique to create theories of principles. This can be done on a geophysical concept which is oriented on health related effects. Khalilov has developed and realized such a concept with the following parts:

- Starting point have been studies to control the applicability of GRT, SRT, QT and Newton's laws on gravitational effects on earth which were influenced with big masses (water tanks) between the gravitational measuring system and the surface of the earth the deployment of a technology to measure the variation of the gravitational field (ATROPATENA).

- These results are integrated into the development of a system to use the measured results of the modifications of the gravitational fields for a prognosis of earthquakes

- Then an international widespread measuring network was installed to use their data for the geographical allocation of the predicted earthquake

- The next step was the creation of a technology for earthquake and tsunami resistant buildings and its patent (jointly with Kofler)

- Then a platform had to be developed to simulate well definite earthquakes. This was made to test the stability of walls built according to the created technology (“dancing walls”).

So all the steps could be realized which can be responsible for applied scientists.

The compatibility was to prove of the paradigmatic background with the indispensable prerequisites of the Extended View. This can be confirmed: The applied considerations of Khalilov allow their integration as subsets within the paradigm of the EV as ground set.

The so won experiences can be used as prototype to handle with similar conflict areas between different disciplines of real science, which are related just partly with health aspects.

## **1. The Relationship With The Extended View**

### **1.1. General Problem Statement**

Geophysics is an applied science. It focus on studying the structure of the Earth, searching for mineral resources, studying and forecasting earthquakes, volcanic eruptions, tsunamis, landslides and other natural disasters. A special segment of geophysics deals with the prediction of different natural disasters. Such disasters can cause serious risks for health and life but also for housing and living conditions. This is relevant for medicine. Many other scientific disciplines have similar linkages to health: Medical scientists need their support for special measurements or a better understanding of diseases. Medicine needs support from geophysics for early prediction of natural

disasters. Their advice is a prerequisite for the adequate allocation of health oriented resources and preventive activities. Health oriented land use-, town- and country planning have to include the results of geophysical research especially in context of possible related disasters. Therefore the technical progress in the development of economic earthquake and tsunami resistant building is of great strategic relevance for Public Health.

## **1.2. Cosmic and terrestrial aspects**

The knowledge about the gravitational field and its modification is the starting point for many related considerations. The General Relativity Theory should be expected as the Gold Standard for such measurement. But actual results do not coincide often in geophysics with those theoretically calculated when measuring gravitational anomalies - neither with such ones with GRT nor such on the basis of Newton's laws. Therefore, geophysicists are forced to introduce special amendments when calculating the gravitational field of the Earth. The gravitational anomalies registered with the help of high-precision electronic digital gravimeters made it possible to register gravitational effects, which cannot be explained neither by Newton's theory nor with the General Theory of Relativity. To explain these effects, quantum theory of gravity can be used most effectively. A complex system of equations is needed to deal with the effects in a special geophysical situation, e.g. to take into account the centrifugal force of the Earth's rotation, the shape of the earth (Geoid), the influence of lateral masses (mountains), the Lunar and Solar tides etc. In addition, the influence of the height of the device above the earth, corrections for intermediate layers, and so on are taken into account.

### **1.2.1 Geophysicists and cosmologists focus on processes of different evolutionary periods**

The interest of cosmologists and of geophysicists can be seen from the evolutionary point of view: Cosmologists are interested on the influence of gravitation on entities which occurred first time shortly after the inflation and are characterized just with their masses, distances and movement. Geophysicists deal with geological structures and processes with many billion years of additional evolution. We should not be surprised if such long periods of dynamic processes can modify influences. But cosmology offers just a model for the follow up of the occurrence of more complex physical entities without a proposal for the nature of the related modifications. The situation in geophysics is similar. So the available data and lack on answers can stimulate to think about additional paradigms which would make the same prediction for the actually conclusive phenomena and possible interpretations of not sufficiently explainable phenomena.



We learned from other processes that, it is possible to observe classic ancient processes also in highly evolved entities: So all processes in living beings - from microbes and amoebas up to Einstein and Karajan - are based on activities of proteins in correspondence with the genome. Therefore you cannot decide on the basis for the observed proteomic processes from which type of entity the data are. It can be from e.g. a leukocyte, a cell of the liver or of the brain. It can be from a frog or of Einstein. The characterization of different types of cells is based on totally other criteria. But the prerequisite for all the criteria is the dependence on proteomics and therefore also from genomics. They are modified more or less according to the evolutionary level. Therefore it would be possible to express even the elucidated activities of Einstein and Karajan as “nothing else then” proteomics. This would be an extreme reductionism if this should explain the creativity of them. But the focus on the level of proteins can be the adequate level if the question is to distinct different types of e.g. lung cancer.

### **1.2.2. Would a different paradigm be helpful?**

Why we should not have comparable situations in the demands to understand gravitation? Einstein handled the problem of the unclear perihelion of Mercury better with the newly created GRT. In this case he had to integrate just the planet as a comprehensive entity. Mercury could be sufficiently characterized with its mass and its distances to other masses of planets and the sun. A fictive astronaut sitting on the Mercury could summarize the earth in a similar way. He could also characterize the movement of the earth on the basis of its mass and relationship to other planets, the moon and the sun just on the basis of GRT.

The result should be identical even in a situation with and without big earthquakes and eruptions of volcanoes. The geophysicist would observe relevant differences. Same can be explained with the different results of the use of Newton's formulas, but not all. The formula of Newton can be applied even for the famous study of the influence of the mass of the sun on the way of a beam of light passing the sun on its way to the earth. The use of Newton would predict an inclination of 0,79 “, the use of the RT confirmed the prediction of Einstein: 1,58 “.

The paradigm of Einstein allows to explain this e.g. with the high speed of the light in relation to the much slower speed of e.g. falling rocks or missiles. But the speed of the light is also a result of the evolutionary process. Therefore the explanation of Einstein is not in contradiction to a paradigmatic position which allows to discuss the option: Can both - the difference in the inclination and the speed of the light and of masses - be understood as a consequence of the evolutionary process? You are right! There is no urgent need to ask such a question in relation to the differences of the

reflection of light. But maybe it could be helpful to deal with the understanding of masses or with causation of the extremely surprising accuracy of the characteristics of the particles within the standard model. And there are other reproducible but not understood phenomena of effects of gravitation. So Khalilov made the following experience: The measuring results with a gravimeter under a tank with 25 tons and above the tank did not correspond to the theoretical values that should have been in the ideal case. These experiments were repeated hundreds of times over several years with the same result. Khalilov pointed out that these empirical facts are challenges for the understanding as well of the GRT as of Newton's law. He proposed to discuss the explanation on the basis of quantum theory [1].

Weber observed unexplainable but reproducible phenomena in connection with gravitational waves which were measured with antennas of gravitational-radiation detectors [2]. Such incompatibilities are respected in the statements of Carl Friedrich von Weizsäcker. He honored the creation of the GRT as the only relevant physical theory which would not be available if its creator - Einstein - would not have existed. ” *But .. the relationship of this theory to the rest of physics is up to now not really clear. The theory is to compare with an unredeemed partial payment for anything up to now unknown; Einstein himself has seen this similar.*” [3]

Einstein confirmed this position in his last lecture (Princeton, April 1954 [4]): *“The description of matter in the GRT thanks to a tensor is a makeshift, anything transient; similar a “wooden nose on a snowman”. ...These cause the impression that the GRT is not more truthful as any other classic theory.”*

Therefore physicists of any type of research field are invited to contribute to the needed discussion about to compatibility of the GRT with other indispensable theories.

### 1.2.3. Another type of influence of the observer?

No discussion is required on this topic as it has been proven true: Especially quantum physicists can influence with the selection of the experimental design the type of physical reaction. This fits e.g. to the position that even particles are able to perceive but in a different way as a human observer. But it is valid for every perceiver that the observed is valid to have a choice for activity.

The related decision is influenced thanks to the perceived. But maybe there is another influence of the selected tool for scientific observation: To decide with the selection of the observable dimension of the size of the research object the evolutionary level of the research object. You see the same but with more details if you use a magnifier. But the use of an electron microscope allows totally different and additional information of the same research object. The scale of the entities and processes in our

universe covers the area from  $10^{-35}$  up to  $10^{26}$ . Morris et al described this in an impressive way in their book “Powers of ten” [5].

So we have to discuss: Do we use the correct term if we name any process with in the cell a “biological process”? Or should we distinct between biological, physical processes etc. within a cellular setting? Maybe we simplify our communication if we name all processes which were handled on a more fundamental level with the same term as the creator attributed when he has introduced the term into scientific communication e.g. for an evolutionary younger level. Newton introduced the term “gravitation” on the level of processes which can be handled adequately according to the modern terminology between entities on the level of light matter. Einstein used the term “gravitation” as “field of gravitation” for interactions of the formulas for time-space and the most fundamental entities expressed as fields on the basis of SRT.

Such lacks on coincidences are real challenges for astrophysics, cosmology, theoretical and classic physicists and especially for geophysics. But are these applied and fundamental questions also relevant for medicine?

### **1.3. A methodological proposal**

Einstein proposed a technique to make compatible former incompatible but indispensable theories. He called such scientific models “Theory of principles”. Einstein characterized this technique as follows [6]: *“The theorist’s ... work falls into two parts. He must first discover his principles and then draw the conclusions which follow them. For the second of these tasks he receives admirable equipment at school. ... The first of these tasks .... is of an entirely different nature. Here there is no method capable of being learned and systematically applied so that it leads to the goals. The scientist has to worm theses general principles out of nature by perceiving in comprehensive complexes of empirical facts certain general features which permit of precise formulation. Once this formulation is successfully accomplished, inference follows on inference, often revealing unforeseen relations which extend far beyond the province of the reality from which the principles were drawn.”*

The first part is a philosophical-abstract endeavor - not a natural scientific one. It deals with the invention of paradigmatic principles “beyond” the actually accepted stay of knowledge. Therefore the principles does not deal with discipline related definitions ore formulas but assumptions in which way we should assume our world. This is the part thanks to that nonmedical disciplines can be made compatible with the fundamental positions about the view of the world of medicine. The invention of this fundamental must be created so clever and general that the traditionally used paradigms of e.g. physics and of medicine do not exclude their interpretation to be in agreement with the fundamental paradigm.

The second part deals with the adjustment of the given indispensable, but actually incompatible definitions, formulas and/or logic conclusion. The goals are more general definitions, formulas and/or logic conclusions. This is the application oriented scientific part. The specific knowledge of the related scientific disciplines is the prerequisite for the success of this endeavor. The given task in geophysics deals with topics of Relativity Theories, Quantum Theories, mechanics, cosmology and geophysics, but not of medicine. There is a hope that they will be able to fulfill the prerequisites for a joint theory of principles for geophysics. But such a success would not influence the direct conclusions for medicine: These depend on the compatibility of part one. But indirect aspects could be health relevant: e.g. better prognosis of the occurrence of earthquakes, more appropriate constructed houses etc.

The statement above is in principle relevant not only for geophysical approaches but for any gap between the power of scientific disciplines - with or without direct or indirect effects on health. But many of such disciplines are relevant even indirectly for health.

#### **1.4. Consequences**

Therefore the medical interest is focused on part one. But there is a difference to the classic application of the technique which is proposed by Einstein if we speak about geophysics and indirect health effects: We do not need to create a new paradigm covering health: We have to prove the compatibility of a paradigm which is assumed as ground set for the interpretation of given implicit used paradigmatic positions which are used by geophysicists as subsets. We accept that no paradigm can claim to be the final answer about that “what fit objectively together our world”. We share the position of Einstein: Paradigms (and any term, symbol, natural laws etc.) are just “free inventions of the human mind”. Their justification is based on the additional power to deal better with our daily life - even our daily scientific live. Better means “problem oriented and so economic as possible. Therefore we extend our restrictions about the obligingness of paradigms. We recommend to use paradigms just as problem oriented tool. Therefore it is correct to use even finally unacceptable paradigms if the demand of the given problem does not justify the high effort of the finally accepted paradigm. So it is sufficient to accept temporarily the paradigm “the earth is a plate” if your problem is to control the correct work to build a wall. Then you can use a water scale. The water scale is based on lines parallel to the earth. There are no parallel lines! But the answer of the water scale is sufficient. But you should use another paradigm if your problem is the find the shortest distance between New York and Frankfurt. Therefore it makes not only sense to focus problem oriented on specific paradigms in the different scientific disciplines. This ongoing is the only applicable way. But it would be unscientific to insist on such a position if the problem deals with more complex and other disciplines integrating

aspects. Not any geophysical approach is direct or indirect oriented on the relevance for health. Therefore we have to select between the different geophysical research work and have to select for the proving on compatibility a geophysical approach which is focused on health aspect. There is just one scientific concept which fulfills this prerequisite. The system of research and its application of Khalilov. He analysed the basics and their applicability over his life time as fundamental and applied researcher. Therefore this concept is used to prove the compatibility of the different geophysical approaches on the compatibility with the Extended View.

### **1.5. Special fundamentals of the Extended View**

The implicit used paradigmatic positions of Khalilov are proved on compatibility with the following principles of the Extended View.

- All what can be observed is based on auto poietic evolution based processes
- Actors have caused these processes thanks to their **potentials**. It is assumed that just one substance [according to the philosophical understanding of this term] is the carrier of this just one potential. Therefore the Extended View can be classified as evolution based constructive substance monism in a philosophical view.
- The world is assumed as **not ideal**. Therefore the actors and their potential are also assumed as not ideal (Restricted Autonomous Actors)
- An expression of that is that potential of the basis actors cannot be won or lost (**conservational principle** - generalized from the conservation equations of physics).

Therefore the focus / allocation to one realization or intention must be linked with avoidance of others. This **principle of inhibition/enforcement** is generalized from the similar physiological principles discovered thanks to Sechenov and Pavlov)

○ This position implicates different abilities:

a. to be able to perceive, to be able to attribute meaning to perceived or observed, to anticipate possible consequences of effects even in relation to former ones (anticipation - memory), to make differences between perceived or expected, to deal creative with relations between positions (relativity) and meanings (relationality), to intend to reach or to avoid effects (intentionality), even such ones which never have seen before (evolution!) to be able to communicate thanks to agreements and

b. to realize effects

○ We propose to distinct between two types of effects of the use of the potential:

a. "Discrimination" is used as term to cover the abilities for different forms of constructions according to point a) above even in a creative way.

- b. “energy” as term to use the effects of realization according to the physical understanding to modify the position in a geometrical grid
- The option to deal with and to share results of discrimination with others causes the need to integrate tools which allow to communicate about relationality (joint meanings, expressed as information) and about relativity (about the position with a jointly accepted geometrical grid). Therefore **two grids** have to be postulated:
    - a. One to deal with positions and their modification in relativity to others - thanks to (physical) movement
    - b. One for the attributed individual meaning to positions and constructions and their relationality to others and to deal with the generalized meaning thanks to the agreement about the relationality based on the jointly attributed meaning = information
    - c. Both grids are linked with a joint “coordinate”: We call this “time”. Time can be used as measure for the speed to modify the geometrically characterized position. But time can express also the available or used period the decide to change e.g. the attributed meaning to matter (information) in a special way or to insist in the given one.
      - **The actors are not ideal they are restricted autonomous.**
        - They cannot reach the intended goal even if the intended goals are accepted as ideal.
        - The use of potential cannot make a rest: Both aspects act all the time fully. This is a prerequisite that there are aspects in our world which can be researched.
        - The expression of the not ideal nature of any observer is complementarity: The allocation on one type of efficiency excludes [7] the perceiving or observation of the related effect of the other one.
        - The relationship between the use of potential for realization and construction can be modified. The modifiability is a prerequisite for the **evolutionary process**.
        - But both abilities (energy and discrimination/creativity) are the expression of just one potential. Therefore they are all the time linked, even we neglect the linkage: So energy explains just movement, but not the direction of movement. And the attribution of information/meaning needs all the time a energetically based structure.
        - **The evolutionary process:** The evolutionary process is understood as the unintended consequence of intended interactions of Restricted Autonomous Actors thanks to the application of their potential with the intention to increase the surplus or to reduce a self-referenced harm. More details are puolished in this volume.
        - The ability of RAA (restricted autonomous actors) to attribute and to modify meaning to energetical structures or constructions and the ability to realize makes plausible the occurrence of the emergent. But emergence is just the prerequisite of evolution.
        - The emergent can be part of an evolutionary process if the attributed meaning to the structure or construction is accepted and used also by others.

a. This is to expect only if its use will increase the surplus or reduce the harm. Both prerequisites are given in a **WINWIN**- situation. Both actions are based on voluntariness: The restrictions which are the prerequisites for the new progress (e.g. the structure of figures of chess, the attribution of “names to them” and the acceptance of the principles of the allowed movements of the chess figures cannot be explained logically with the nature of the material from which they are made (e.g. wood). But the agreement about them enables each of the chess player to win a brand new possibility for creativity: To play Chess and to have the chance to win.

b. Therefore it is possible to predict the acceptance of the rules. But not the way to use the creative options which are given thanks to the rules.

c. Such a voluntary surpluses can be the prerequisites for an additional step in the evolution. This is to expect, if the further evolutionary progress is just based on the predictable of its precursors. The individual use is neglected. As long as it is possible to motivate the precursors for the new evolutionary level - in our case Chess-players to play as long you can predict the movement which is correctly linked with the special figure. The emergent progress would be based on an additional meaning of this structure for a new consent. This meaning would be totally different from the meaning for Chess. But it can be used as part of a new consent for the next level of evolution. The emergent new would persist, if the consents would allow a new WINWIN - as described above.

d. But it is obvious: Even the processes of the actors which share the agreements of the new level would be “special cases” of the applications of Chess-Figures and their rules.

o This we can now link with Einstein, Maxwell and Newton:

The processes of Newton (mechanics, “light matter”) and of Maxwell (electromagnetism) can be understood as special cases of the principles of their ancient precursors. Einstein postulated the energetical fields as their precursors. Then he modified the formulas of Newton and Maxwell up to the point that the new formula (the Special relativity Theory) covered the formulas of Newton and Maxwell like a ground set for “Newton” and “Maxwell” as subsets. It is obvious, that these formulas are further on in power for the classic applications of the processes on the evolutionary younger level of electro magnetic fields and light matter.

Now we can transfer this into principles of the Extended View which should be compatible as well with the positions of a generally applied understands of geophysics as with the different sectoral theories which are used actually in geophysics.

Therefore the proving of the compatibility of paradigmatic positions can be decided on few prerequisites:

- 1) Is acceptable that our world is not ideal?
- 2) Is the position in contradiction to an evolutionary understanding?

- 3) Is accepted that there are aspects in our world which can be matter of scientific research, which are not part of the special research field - but have to be accepted also as expression of the ONE evolutionary process?
- 4) Is accepted that science is an invention to deal better with our world?
- 5) Is accepted that the power of science is restricted and that science cannot claim to give finally objective answers. “Objectivity” or better “inter-subjectivity” can only be expected within the frame of the used paradigm.
- 6) There must be the willingness to accept that individual processes need also a necessary and sufficient causation.
- 7) The explanation of the causation of natural processes thanks to natural laws is not a contradiction as long as the origin of natural laws remains open. Incompatibility of a model would be given natural laws guides all processes to predetermined goals (Intelligent design) or similar world views.

## **2. THE RELATED GEOPHYSICAL APPROACHES**

Khalilov has developed and realized such a concept with the following parts:

- 2.1. ATROPATENA: Starting point was the deployment of a technology to measure the variation of the gravitational field (ATROPATENA)[9];
  - 2.2. The development of a system to use the measured results of the modifications of the gravitation fields for a prognosis of earthquakes [10];
  - 2.3. The implementation of an international widespread measuring network to use the data for the geographical allocation of the predicted earthquake;
  - 2.4. The creation of a technology for earthquake resistant buildings and its patent (jointly with Kofler) [11, 12, 13];
  - 2.5. The development and realization of an platform to simulate well definite earthquakes to test the stability of walls built according to the created technology (“dancing walls”);
- So all the steps could be realized which can be responsible for applied scientists [13].

## **3. PROOF**

Intensive discussions and correspondence have taken place between the authors about the paradigmatic positions which are the background of the related geophysical approaches (e.g. [14]). It is relevant to distinct between the general world view for daily life, different positions to other scientific disciplines and the paradigms which are the basis for the geophysical approaches.



- The positions of the general worldview can be neglected by geophysics: They did influence neither the study designs nor the logic argumentation with the scientific work about earthquakes etc.
- Geophysics is seen as one of many scientific disciplines with more or less interlinkages. The paradigm to focus the scientific work on health related applicability of geophysics is the consequence of a special ethical position. The evolutionary principle is accepted in the general and Darwin's understands of evolution in the special. Darwin accepted just one evolutionary process for the whole universe. But he had to restrict his work on the origin of species on one hand and the further evolutionary progress of homo as primat to the person as a social being. He could explain the modifications of species from basic living beings thanks to natural selection. But he postulated an additional evolutionary principle for the progress to the person as socio-cultural being: He proposed "sympathy" (The descent of man). There was no need to integrate e.g. cosmological aspects (e.g. inflation) into the considerations and not sufficient available data for the evolution of life from inanimate entities. There are no links to models like intelligent design.
- The paradigmatic positions in the geophysical work were problem oriented and realized with respect to the fact, that physics is not based on a unified paradigm. Therefore a critical and creative use was needed to apply positions of Einstein, Quantum theories, of classic physics and the experiences of the personal research work. Such an ongoing covers implicit (Einstein's) positions with active movement of physical entities which are able to perceive other physical entities and guide themselves to avoid collision [15]. Especially Newton's positions are based on the power of natural laws. But there is no need to explain their origin according to the Extended View: It is allowed and recommended to use paradigmatic positions if they are helpful: Science is an invention of humans. Every single earthquake needs its individual explanation based on the causation with respect to its special conditions, but are to integrate into the results of ATROPATEN Astation for the forecasting of earthquakes.
- This gives the hope to go forward to unify the different paradigmatic positions of physics.

The used paradigmatic positions are compatible with the Extended View.

## References

1. Khalilov E.N. Method for recording gravity quantum effects and device for carrying out said method. World Intellectual Property Organization (WIPO), Geneva, Publication Date No: 16.06.2005, Publication № WO2005/054901 Download:

2. <https://patentscope.wipo.int/search/en/detail.jsf?docId=WO2005054901>,
3. Khalilov E.N. Method for registering quantum gravitational radiation. World Intellectual Property Organization (WIPO), Geneva, Publication Date No: 05.03.2015, Publication № WO/2015/027299
4. Weber J.: Gravitationsstrahlung, in: Aichelburg PC & RU Sexl (eds.) Albert Einstein: Sein Einfluss auf Physik, Philosophie und Politik, Vieweg Braunschweig/Wiesbaden, 1979., 27 - 34 in German
5. Weizsäcker CF von: Einsteins Bedeutung für Physik, Philosophie und Politik, in Aichelburg PC & RU Sexl (eds.) (rest see above) 1979 165 -175 in German
6. Einstein A: The last lecture, presented 14 4 1954 in Princeton University, noted by JA Wheeler, published by JA Wheeler in: Mercer Street und andere Erinnerungen, in Aichelburg PC & RU Sexl (rest see above), 1979, 211-221 German Edition
7. Morrison, P., Morrison, P., Eames, C. & Eames, R. (1982) Powers of Ten. New York.
8. Einstein A: Prinzipien der Theoretischen Physik, Inaugurationsvortrag Preußische Akademie der Wissenschaften, Proceedings, II, 739-744, 1914, English in: Ideas and Opinions, Three Rivers edition, 220-223
9. The period from Big Bang to Atom is characterized with a -quasi-unlimited availability of potential quasi-ideal reactions. Therefore we have to expect quasi-ideal effects of focus and inhibition in e.g. theoretical physical processes. This explains the position of N. Bohr when he introduced the term “complementarity”. The situation changed during the evolutionary process in quantitative but not in qualitative way.
10. Khalilov E. N. (2013). Earthquake prediction method and device for the implementation there of, Geneva. WO 2013/096997, Eurasian Patent 018373. Geneva: World Intellectual Property Organization (WIPO).
11. Khalilov E., Wang L., Khalilova L. Analysis of global gravitational precursors before some Asian strong earthquakes. Geophysical Journal, № 2, v. 41, Kiev, 2019, pp. 141-155.
12. Khalilov E., Kofler W. Antiseismic construction. PCT, WO/2007/051262, 10.05/2007, WIPO, Geneva. European Patent: EP 1947248 A1 20080723 (DE)
13. Kofler W., Khalilov E. Seismic block. Eurasian Patent №EA201400126 A1, 2015.04.30.
14. Kofler W., Khalilov E. Perspectives of application of new technology of seismic resistant construction in Yogyakarta – Special Region of Indonesia. Science Without Borders. Volume 2, 2006/2006, ICSD/IAS, Innsbruck, 2006, pp.340-346
15. Darwin Ch. The Descent of Man, and Selection in Relation to Sex, J. Murray, London 1871
16. Russell B: The ABC of Relativity. Kegan Paul, Trench, Trubner, London 1925

## **ACTIVE BRACE CONTROL OF FRAME STRUCTURES UNDER EARTHQUAKE EXCITATION**

**Sinan Melih Nigdeli**

*Istanbul University, Faculty of Engineering,  
Department of Civil Engineering, Turkey,  
[melihnig@istanbul.edu.tr](mailto:melihnig@istanbul.edu.tr)*

### **Introduction**

Structural vibrations resulting from earthquakes cause serious damages on civil buildings. Also, valuable devices and non-structural elements can be damaged during big unstable vibration. Thus, structural control concept may be implemented to important structures in order to prevent structural and non-structural damages. There are various types of structural control, such as active, passive, hybrid and semi-active. Passive control devices are more economical according to active control. Passive control helps to damping of vibration with mechanical materials. Especially, passive tuned mass dampers was placed to several important structures under wind excitation and several studies showed that optimum passive tuned mass damper are effective on reducing earthquake indicated structural vibration [1-3].

Active control devices apply time varying forces to structures in order to protect them from unstable excitations like earthquakes. But, active control systems may be expensive and may need big control forces and big power supplies. Semi-active systems, which may be accepted as active system with lower efficacy, consume less power than active ones. Hybrid systems, which are the combination of active and passive systems, may be more effective on force and power reduction. In that case, when tuning active control devices, control force value must be considered in order to keep it at a minimum level. The time delay is also a problem for active control systems. In the tuning process, a realistic time delay must be considered.

Otherwise, the system may be unstable under random vibrations and this situation will be the failure of the protection system. In this paper, an active brace controlled single storey frame structure was investigated under earthquake loadings. At the end of the analysis, time and frequency domain results were compared for the uncontrolled and the controlled structure. Several studies about active control of structure were mentioned here. Wong and Hart investigated the controlled response of inelastic structures and presented an active tendon controlled frame structure as a sample [4]. Lu and Skelton

proposed a method for integrated design of passive and active elements including active braces [5]. Arfiadi and Hadi controlled three-dimensional buildings with passive and active systems such as active tuned mass dampers, passive tuned mass dampers and active braces by using genetic algorithm as a function optimizer [6]. In order to demonstrate the practical applicability of active control, experimental tests using a full scale three storey building equipped with active braces were conducted on the shake table at the National Center of Research on Earthquake Engineering (NCREE), Taiwan [7].

Lu and Zhao investigated active brace controlled structures with controllers extended by introducing the saturated control method [8]. Gluck and Ribakov developed an active controlled viscous damping device with amplifying braces [9]. Arfiadi and Hadi used a continuous bounded controller for active brace controlled structures and proved their study by applying different earthquake excitations with various intensities [10].

Han and Tsopelas developed a passive/active brace system (PAB) which is the combination of a piezoelectric stack actuator and a viscoelastic damper [11]. Pnevmatikos and Gantes investigated structures with diagonal braces combined with active variable stiffness devices that have an ability to activate or deactivate the braces [12]. Nigdeli and Bodurođlu investigated active tendon controlled structures with PID controller in order to prevent earthquake indicated big vibrations [13]. Torsionally irregular single storey structures with active tendon control were investigated by Nigdeli and Bodurođlu under earthquake excitations [14]. In this study, a single storey frame structure equipped with a diagonal active brace was analyzed under earthquake excitations. The Proportional Integration Derivative (PID) type controller was used for obtaining the control signal. The time delay effect was also considered in order to obtain realistic results. For more economical and practical results, the amount of the control force was held at a minimum level. The controlled and the uncontrolled structure results were compared including the rotations and moments at the conjunction of the beam and the columns.

### **Frame structure model and equations of motion**

Model of the frame structure with active brace control is shown in Fig. 1. In Fig. 1,  $m_c$ ,  $L_c$  and  $EI_c$  represent the unit mass per length, the length and the rigidity of the columns, respectively. Also,  $m_b$ ,  $L_b$  and  $EI_b$  represent the unit mass per length (including storey mass), the length and the rigidity of the beam, respectively. The frame structure has three degrees of freedom. These freedoms are the lateral displacement of structure

respect to the ground ( $x$ ) and the rotations at the beam column conjunctions ( $\theta_1$  and  $\theta_2$ ). The equations of motion of an uncontrolled single-span single storey linear frame structure subjected to earthquake loading can be written as

$$M\ddot{x}(t) + C\dot{x}(t) + Kx(t) = \begin{Bmatrix} m_t \\ 0 \\ 0 \end{Bmatrix} \ddot{x}_g(t) \quad (1)$$

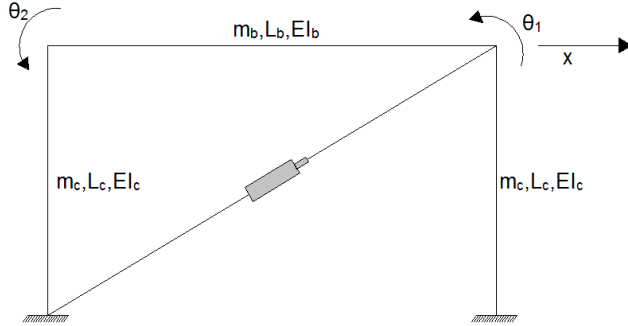
where  $M$ ,  $C$ ,  $K$  are mass, damping and stiffness matrices, respectively. Total mass of the building and ground motion acceleration are shown as  $\ddot{x}_g(t)$  and  $m_t$ , respectively.  $x(t)$  is the vector of the freedoms.  $\ddot{x}(t)$  and  $\dot{x}(t)$  are the derivatives of  $x(t)$ . The  $M$ ,  $K$ ,  $C$  matrices and  $x(t)$  vector for three degrees of freedom system are given in Eqs. (2), (3), (4) and (5), respectively.

$$M = \begin{bmatrix} \frac{156}{210}m_cL_c + m_bL_b & \frac{11}{210}m_cL_c^2 & \frac{11}{210}m_cL_c^2 \\ \frac{11}{210}m_cL_c^2 & \frac{1}{105}(m_cL_c^3 + m_bL_b^3) & \frac{-3}{420}m_bL_b^3 \\ \frac{11}{210}m_cL_c^2 & \frac{-3}{420}m_bL_b^3 & \frac{1}{105}(m_cL_c^3 + m_bL_b^3) \end{bmatrix} \quad (2)$$

$$K = \begin{bmatrix} \frac{24EI_c}{L_c^3} & \frac{6EI_c}{L_c^2} & \frac{6EI_c}{L_c^2} \\ \frac{6EI_c}{L_c^2} & \frac{4EI_c}{L_c} + \frac{4EI_b}{L_b} & \frac{2EI_b}{L_b^2} \\ \frac{6EI_c}{L_c^2} & \frac{2EI_b}{L_b^2} & \frac{4EI_c}{L_c} + \frac{4EI_b}{L_b} \end{bmatrix} \quad (3)$$

The damping matrix was generated by using the Rayleigh damping proportional to the mass and stiffness matrix. In Eq. (3),  $\alpha$  and  $\beta$  are the coefficients of the Rayleigh damping [15, 16, 17].

$$C = \alpha M + \beta K \tag{4}$$



**Fig. 1. The Frame Structure with Active Brace Control**

$$x(t) = [x \theta_1 \theta_2]^T \tag{5}$$

The equations of motion of an active brace controlled single-span single storey linear frame structure subjected to earthquake loading can be written as seen in Eq. (6). In this equation,  $u$  and  $\alpha_0$  are the control signal and the angle of active brace with respect to ground, respectively.

$$M\ddot{x}(t) + C\dot{x}(t) + Kx(t) = - \begin{Bmatrix} m_t \\ 0 \\ 0 \end{Bmatrix} \ddot{x}_g(t) - \begin{Bmatrix} u \\ 0 \\ 0 \end{Bmatrix} (\cos \alpha_0) \tag{6}$$

The control signal is the force applied from active braces and the multiplication of the control signal with the cosine of the angle between ground and the brace is the control force. In order to obtain the control signal, PID type controller was used. The equation of the PID controller can be seen in Eq. (7). In this equation,  $K_p$  (Proportional gain),  $T_i$  (Integral time) and  $T_d$  (Derivation time) are controller coefficients. By using the control algorithm, the error signal ( $e(t)$ ) can be transformed into control signal. The error signal is taken as the velocity of the lateral motion. The controller coefficients were tuned by using a trial method by considering the maximum control force value.

$$u(t) = K_p \left( e(t) + \frac{1}{T_i} \int e(t) dt + T_d \frac{de(t)}{dt} \right) \quad (7)$$

In order to obtain realistic and trusted results, a 20 ms time delay of the control system was assumed. The block diagrams of the controlled and uncontrolled structure were developed by using Matlab Simulink. Runge-Kutta method with 1e-3 step size was used for the numerical analysis.

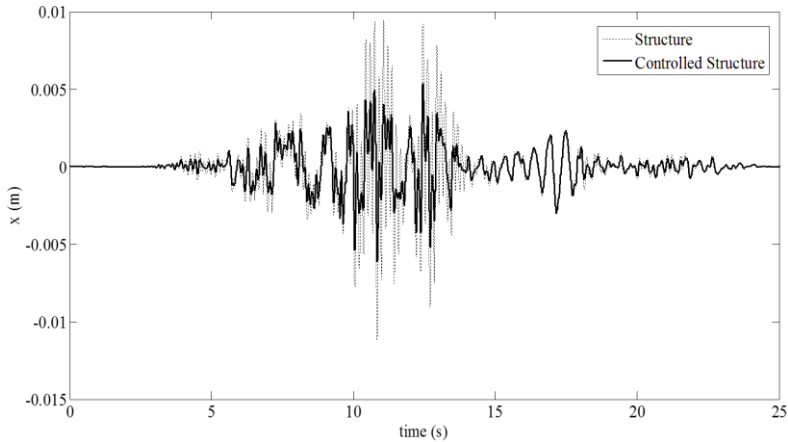
### Numerical example

The frame structure was analyzed under various earthquake excitations. The damping of the structure was assumed as 5% for the first two modes. The properties of the structure and the PID controller can be seen in Table 1.

Table 1

**Properties of the structure and the PID controller**

Symbol	DEFINITIONS	Numerical Value
$m_t$	Total mass of the structure	5250 kg
$m_c$	Mass of the columns per length	250 kg/m
$m_b$	Mass of the beam per length (including storey mass)	750 kg/m
$L_c$	Length of the columns	3 m
$L_b$	Length of the beam	5 m
$EI_c$	Rigidity of the columns	15000000 Nm <sup>2</sup>
$EI_b$	Rigidity of the beam	15000000 Nm <sup>2</sup>
$\alpha_0$	Angle of the active brace respect to the ground	31 °
$T$	Period of the structure	0.15 s
$\alpha$	Coefficient of the Rayleigh damping	3.1961
$\beta$	Coefficient of the Rayleigh damping	5.5795x10 <sup>-4</sup>
$K_p$	Proportional gain	-47200 Ns/m
$T_i$	Integral time	15 s
$T_d$	Derivative time	0.01 s



**Fig. 2. The lateral displacement of the frame structure under Loma Prieta earthquake**

In Table 2, the maximum responses such as the lateral displacement ( $x$ ), the rotations at the joints ( $\theta_1, \theta_2$ ), the total acceleration ( $\ddot{x} + \ddot{x}_g$ ), the shear force at the columns ( $V$ ), the moments at the joints ( $M_1, M_2$ ) and the control force ( $F_c$ ) can be seen under different earthquake excitation for the uncontrolled and the active brace controlled cases. The earthquake records were downloaded by NGA database of Pacific Earthquake Engineering Research Center (PEER) [18]. In Fig. 2, the time history of the lateral displacement of the structure under Loma Prieta earthquake is given with the comparison of the controlled and the uncontrolled cases. Under Loma Prieta excitation, the maximum displacement is reduced from 1.1221 cm to 0.6108 cm (45.6% reduction).

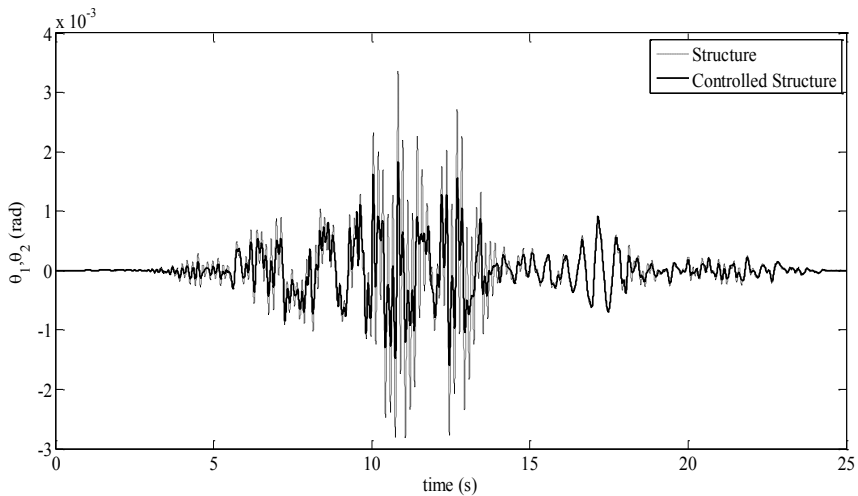
In Fig. 3, the time history of the rotations at the joints under Loma Prieta earthquake is seen. The maximum rotation is reduced from 0.0034 rad to 0.0018 rad (47% reduction). The shear force of the columns can be seen in Fig. 4 under Loma Prieta loading. The maximum shear force is reduced from 82.3054 kN to 44.7806 kN (45.6% reduction). In Fig. 5, the time history of the moments at the joints can be seen under Loma Prieta earthquake. The maximum moments are reduced from 480.2536 Nm to 295.4865 Nm (38.5 % reduction). The transfer functions of the frame structure can be seen in Fig. 6 for the lateral motion ( $TF_x$ ) and the rotations at the joints ( $TF_\theta$ ), respectively. These transfer functions represent the ratio between Laplace Transforms of the accelerations of the frame structure and the ground excitation. The values of the first peaks representing the resonance state of the structure are reduced with the help of the active control.

Table 2

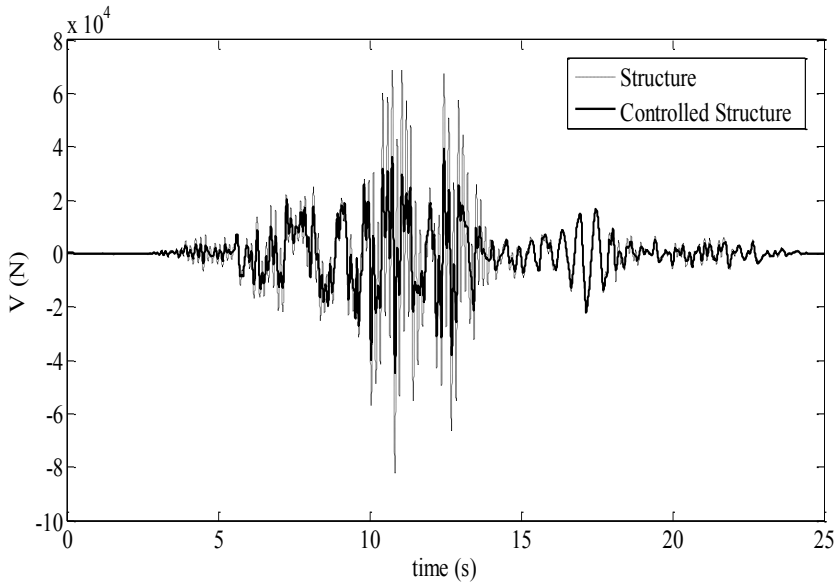


**Maximum responses of the frame structure**

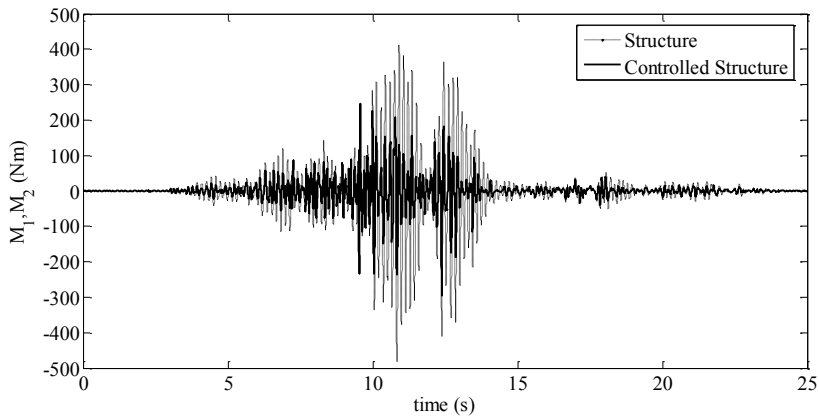
Earthquake records		x (cm)	$\theta_1, \theta_2$ (rad)	$\ddot{x} + \ddot{x}_g$ (g)	V (kN)	$M_1, M_2$ (Nm)	$F_c$ (kN)
<b>Duzce (1999) BOL090</b>	Uncontrolled	0.8427	0.0025	1.3623	61.7522	323.4508	-
	Controlled	0.7190	0.0022	1.1887	52.6511	229.1013	9.6200
<b>El Centro (1940) ELC180</b>	Uncontrolled	0.4372	0.0013	0.7555	32.0814	270.8723	-
	Controlled	0.3227	0.0010	0.6333	23.6787	160.0795	5.4415
<b>Erzincan (1992) ERZ-NS</b>	Uncontrolled	0.4906	0.0015	0.7447	35.9052	113.3049	-
	Controlled	0.4488	0.0013	0.7124	32.8373	69.6165	3.0420
<b>Landers (1992) LCN000</b>	Uncontrolled	1.1734	0.0035	2.0915	86.1456	785.5621	-
	Controlled	0.6227	0.0019	1.3842	45.7781	549.1632	13.6792
<b>Loma Prieta (1989) LGP000</b>	Uncontrolled	1.1221	0.0034	1.9046	82.3054	480.2536	-
	Controlled	0.6108	0.0018	1.1334	44.7806	295.4865	10.3414
<b>Kobe (1995) KJM000</b>	Uncontrolled	1.3290	0.0040	2.2160	97.4460	510.1252	-
	Controlled	0.8105	0.0024	1.4427	59.3987	350.3847	12.5385
<b>Northridge (1994) SYL360</b>	Uncontrolled	0.9209	0.0028	1.5310	67.5206	346.9131	-
	Controlled	0.7304	0.0022	1.3307	53.5471	275.2702	10.2412



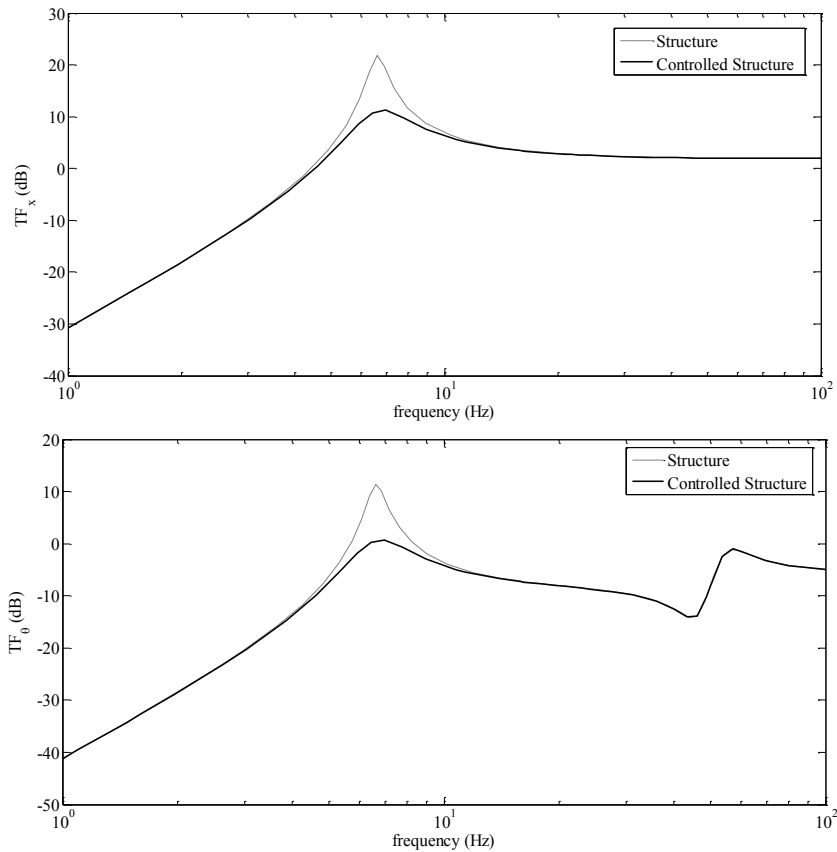
**Fig. 3. The rotations at the joints under Loma Prieta earthquake**



**Fig. 4. The shear force under Loma Prieta earthquake**



**Fig. 5. The moments at the joints under Loma Prieta earthquake**



**Fig. 6. The transfer functions of the frame structure for the uncontrolled and the controlled cases**

### Conclusion

The PID controlled active braces for the frame structures are effective on reducing earthquake indicating structural vibrations. The analysis results under different earthquakes prove that the control system is secure and effective for various conditions even a 20 ms time delay is considered. Also, frequency domain analyses show that the structure can be trustable for different random excitations. With the reduction of the lateral displacements, second order effects are reduced. Also, the active control concept is successful on reducing total acceleration of the frame structure. For the feasibility of the method, the control force must be in an applicable range. The results of maximum control force are well enough to maintain. The maximum control force is 13.6792 kN for Lander earthquake excitation. The actuator must apply this force with 100% efficiency in order to minimize time delay value. Damages at frame structures may be

prevented with active braces because of the reduction at the shear force and moments under different earthquakes. Also, the reaching of moments to plasticity capacity may be prevented.

### References

1. Sadek F., Mohraz B., Taylor A.W., Chung R.M. A method of estimating the parameters of tuned mass dampers for seismic applications. *Earthquake Engineering and Structural Dynamics* 1997; 26:617–635.
2. Hadi M.N.S, Arfiadi Y. Optimum design of absorber for MDOF structures. *Journal of Structural Engineering (ASCE)* 1998; 124:1272–1280.
3. Bekdaş G., Nigdeli S.M. Estimating Optimum Parameters of Tuned Mass Dampers Using Harmony Search. *Engineering Structures* 2011; 33: 2716-2723.
4. Wong K.K.F, Hart G.C. Active Control of Inelastic Structural Response During Earthquakes. *The Structural Design of Tall Buildings* 1997; 6:125-149.
5. Lu J., Skelton RE. Optimal Hybrid Control for Structures. *Computer-Aided Civil and Infrastructure Engineering* 1998; 13:405-414.
6. Arfiadi Y., Hadi M.N.S. Passive and Active Control of Three-Dimensional Buildings. *Earthquake Engineering and Structural Dynamics* 2000; 29:377-396.
7. Wu J.-C. Modeling of an Actively Braced Full-Scale Building Considering Control-Structure Interaction. *Earthquake Engineering and Structural Dynamics* 2000; 29:1325-1342.
8. Lu X., Zhao B. Discrete-Time Variable Structure Control of Seismically Excited Building Structures. *Earthquake Engineering and Structural Dynamics* 2001; 30:853-863.
9. Gluck J., Ribakov Y. Active Viscous Damping System with Amplifying Braces for Control of MDOF Structures. *Earthquake Engineering and Structural Dynamics* 2002; 31:1735-1751.
10. Arfiadi Y., Hadi M.N.S. Continuous Bounded Controllers for Active Control of Structures. *Computer and Structures* 2006; 84:798-807.
11. Han S.-J., Tsopelas P. Active/Passive Seismic Control of Structures. *Journal of Earthquake Engineering* 2006; 10:509-526.
12. Pnevmatikos N.G., Gantes C.J. Design and Control Algorithm for Structures Equipped with Active Variable Stiffness Devices. *Structural Control and Health Monitoring* 2010; 17:591-613.
13. Nigdeli S.M, Boduroğlu M.H. Active Tendons for Seismic Control of Buildings. *World Academy of Science, ICMSE, Paris July 2010*; 68:1258-1264.
14. Nigdeli S.M, Boduroğlu M.H. Active Tendon Control of Structures with Torsionally Irregularity. *Seventh National Conference on Earthquake Engineering, Istanbul 30 May-3 June 2011*.
15. Clough R.W, Penzien J. *Dynamics of Structures*. New York: Mc. Graw-Hill Book Company; 1993.

16. Hart G.C., Wong K. Structural Dynamics for Structural Engineering. New York: John Wiley and Sons Inc.; 1999.
17. Chopra A.K. Dynamics of Structures: Theory and Applications to Earthquake Engineering. 2nd Edition. New Jersey: Prentice Hall; 2001.
18. Pacific Earthquake Engineering Research Center. NGA database: <http://peer.berkeley.edu/nga>.

## **PRELIMINARY RESULTS OF ANALYSIS OF THERMAL SATELLITE AND GROUND BASED RADON DATA RECORDED PRIOR TO HARIPUR EARTHQUAKE, PAKISTAN**

**<sup>1</sup>M. Awais, <sup>2</sup>M. Shahid Riaz, <sup>3</sup>Zeeshan Jilani and <sup>4</sup>M. Qaisar**

<sup>1,2,3,4</sup>*Center for Earthquake Studies, NCP, Quaid-i-Azam University Campus*

*(Islamabad, Pakistan), [emawais@gmail.com](mailto:emawais@gmail.com), [shahid09@gmail.com](mailto:shahid09@gmail.com),*

*[zeshanjln@gmail.com](mailto:zeshanjln@gmail.com), [mqaisar49@gmail.com](mailto:mqaisar49@gmail.com)*

### **Abstract**

Radon gas production occurs continuously throughout the Earth's crust, but when an earthquake is imminent the production of radon decreases in the compression zone near the epicenter and increases in stretching zones away from the associated fault. The release of radon ionizes the surrounding air and creates near-earth plasma in the form of long-living ion clusters. These changes can be detected by both ground- and satellite-based instruments. Investigations throughout the world over the past 15 years provide evidence, which indicate that significant variations of radon concentration may occur in association with major geophysical events such as earthquakes and volcanic eruptions (Al-Tamimi and Abumurad 2001; Chyi et al. 2005; Fu et al. 2005; Walia et al. 2005, 2006; Yang et al. 2005; Singh et al. 2006; Kumar et al. 2009). Due to such observed correlation, radon is considered as one of the few promising precursors for earthquakes (Kumar et al. 2010). In the last decade, several studies have recognized the anomalous behavior of radon gas emission from Earth prior to an earthquake that could be the sign of an imminent earthquake. It is believed that the radon is released from cavities and cracks as the Earth's crust is strained prior to the sudden slip of an earthquake (Chung, 1985; Teng and Sun, 1986). Similarly,

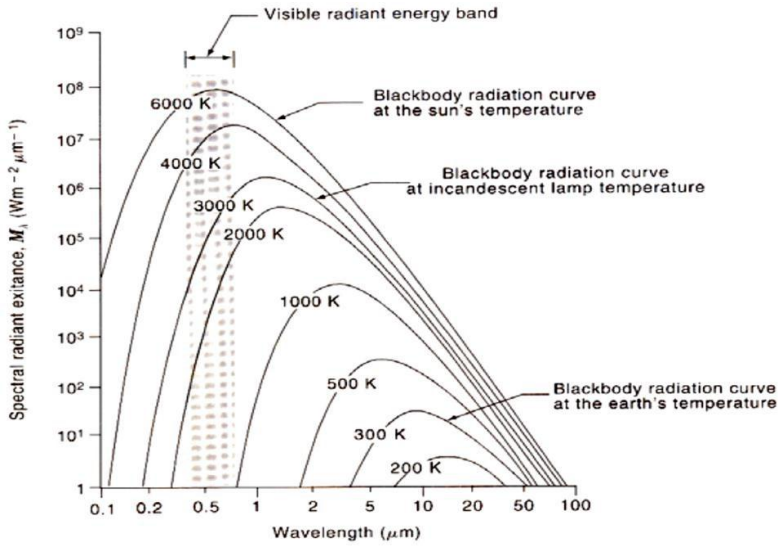
Satellite thermal infrared (TIR) imaging data, from sensors on board satellite platforms, have been reported to record thermal anomalies in epicenter and adjacent areas in the Thermal Infrared (8-14 $\mu$ m) spectral range prior to major earthquakes and associations with fault systems (Ouzounov et al., 2006). The identification of such thermal anomalies is difficult to record from the ground based stations for a large area. The satellite telemeters measure these phenomena quickly round the clock and cover a large area. The satellite data have not only revealed stationary (long-lived) thermal anomalies associated with large linear structures and fault systems in the Earth's crust (Carreno et al., 2001; Fizzola et al., 2004) but also transient (short-lived) features prior to major earthquakes (Tronin et al., 2004a,b; Tramutoli et al., 2005). These short-lived anomalies typically appear 4–14 days before an earthquake affecting the regions of several to tens of thousands square km. It displays a positive deviation of 2–4<sup>0</sup> C or more; and dies out a few days after the event. The thermal anomalies have also been observed at distances of 200–1000 km from the epicenters, between few hours to two weeks before the event occurred in China, Japan, Russia, Turkey, Mexico and Greece; (Liu et al., 2000; Tramutoli et al., 2001). In this paper we will present and discuss recorded radon gas anomaly along with variations in Thermal Infrared (TIR) transients and overall radiation field in the earthquake preparation zone prior to Haripur earthquake ( $m_b = 5.2$ , Lat: 33.871° N Long: 72.890° E, Oct 11, 2010).

### **Methodology and Data Sets**

According to Planck's Law, each warm object emits certain amount of thermal radiation at a particular wavelength depending on its temperature. For a much clearer picture, the relationship between Earth's surface, its brightness temperature and the spectral radiance can be understood by referring to Fig.1 (Lillesand and Kiefer, 2004).

Satellite data of MODIS pertaining to calibrated radiance of cloud free day time was downloaded from the web site: <http://laadsweb.nascom.nasa.gov/> for all the selected earthquake events. The grid of 3<sup>0</sup> × 3<sup>0</sup> was selected in such a way that epicenter of each selected earthquake lies in the middle of the grid for the analysis.

The radiance data of each day, one month before and after the occurrence of earthquake, was critically viewed to ensure the cloud free data otherwise it would represent the radiance of clouds not the earth's surface.



**Fig.1. Black body radiation curves showing peak wavelengths at various temperatures**

The radiance values were converted to surface temperature values, which is more physically useful variable and is the effective at- satellite temperature of the viewed Earth-atmosphere system. The following conversion formula (Liu, 2002) is used.

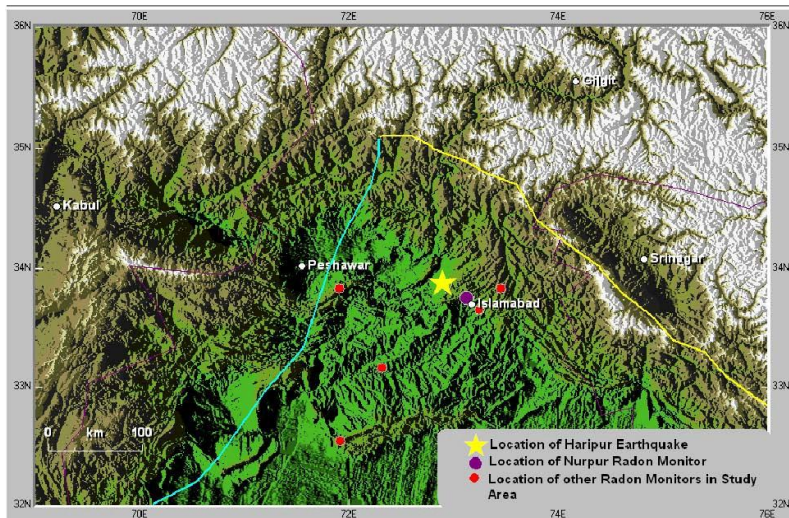
$$T = \frac{K2}{\ln\left(\frac{K1}{L} + 1\right)}$$

Where T is effective at-satellite temperature in Kelvin; K1 and K2 are calibration constant having value 666.09 Watts/ (meter<sup>2</sup> \* ster\* μm) and 1282.71 Temperature degrees in Kelvin respectively and L is spectral radiance in watts/ (meter<sup>2</sup> \* ster \* μm).

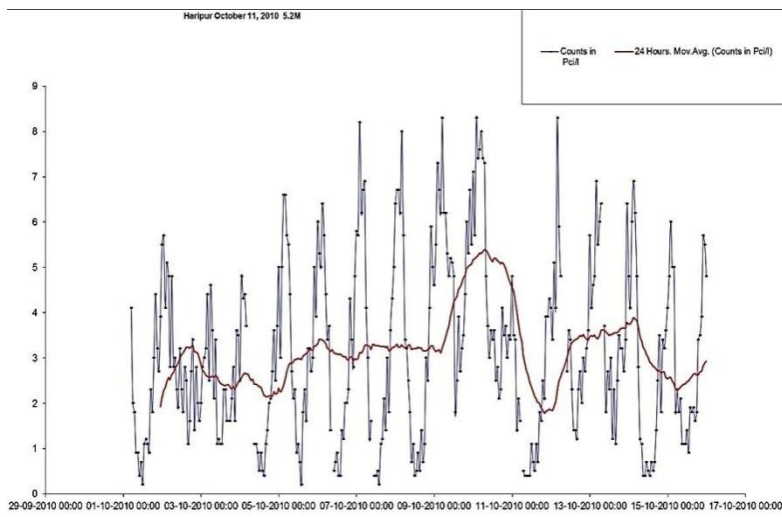
**Results and Analysis Analysis of radon data**

CES is in process of establishing a network of Radon monitors across Pakistan to monitor the Radon anomalous signals prior to earthquakes (Fig. 2).

Radon counts are recorded with one hour interval at each station. Data was averaged out by using 24hrs moving average method. The Analysis of Radon data recorded at nearest station (Nurpur) shows that the average radon counts in the area is 2-3 Pci/l, which were significantly increased to 6-7 Pci/l 1-2 days before the occurrence of earthquake (Fig. 3).



**Fig. 2. Network of Radon monitors in northern Pakistan**

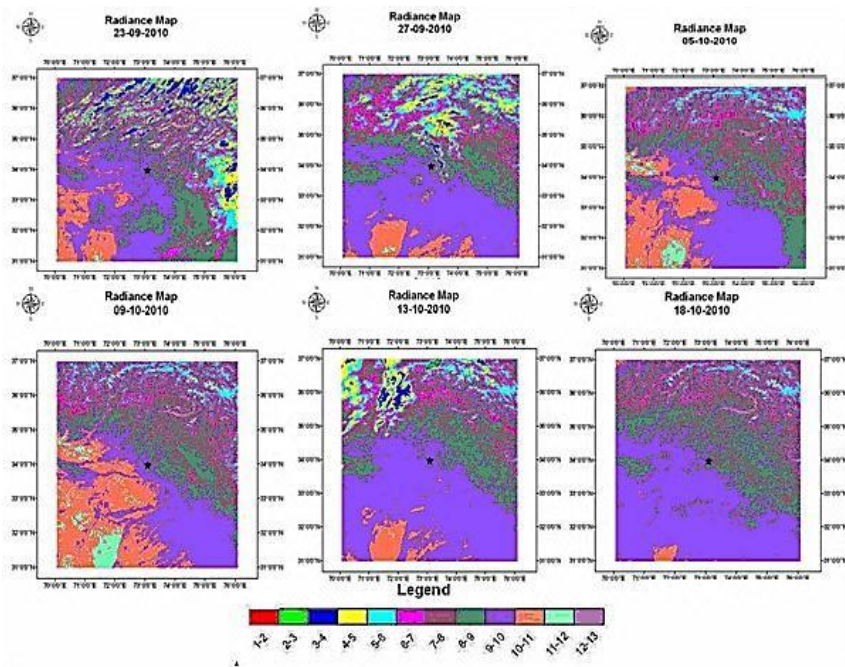


**Fig. 3. Graph showing Radon counts in month of October, 2010**



### Analysis of TIR data

Using ENVI software radiance values (minimum, maximum and average) and the corresponding surface temperature values were noted for all the processed data regarding the following earthquakes for analysis. As the normal temperature of the study area is not available we assume that minimum value of radiance/temperature is normal in the preparation zone for this study.



**Fig. 4. Radiance values before and after the Occurrence of Haripur Earthquake**

From the analysis of processed satellite data for radiance (Fig. 4) and surface temperature values for Haripur earthquake it was observed that the minimum average value of radiance/temperature in the ROI (Region of Interest)

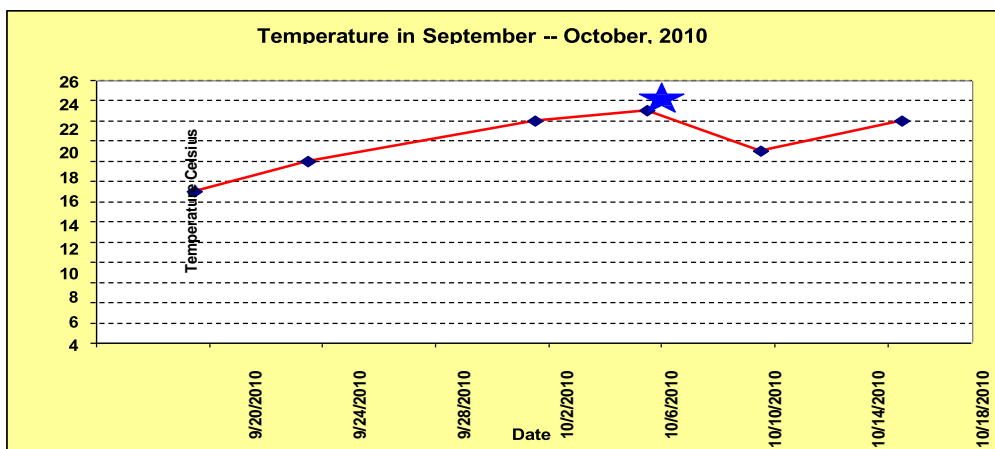
was 7.82/15 on September 23, 2010 which increased significantly and reached at maximum, 8.89/23 on October 09, 2010.

It shows the energy concentration in the epicentral region before the occurrence of earthquake. After the occurrence of earthquake the average value of radiance is decreased significantly i.e. 8.36. The radiance and corresponding temperature values before and after the occurrence of Haripur earthquake is given in Table-1 and corresponding graph is given in Fig. 5.

Table 1

**Radiance and Temperature values before and after the Occurrence of Haripur Earthquake**

Date	Minimum value of	Maximum value of radiance	Average value of	Average Temperature
23-09-2010	2.50	11.85	7.82	15
27-09-2010	2.66	11.13	8.20	18
05-10-2010	3.82	11.79	8.75	22
<b>09-10-2010</b>	<b>3.54</b>	<b>11.61</b>	<b>8.89</b>	<b>23</b>
13-10-2010	2.18	11.03	8.36	19
18-10-2010	3.77	10.97	8.72	22



**Fig.5. Variation of surface temperature before and after the Haripur Earthquake**

## **Conclusions**

Analysis of Radon data reveals that the radon values increased from 2-3 Pci/l to 6-7Pci/l, 1-2 days before the event. From satellite-based study of anomalous behavior of thermal infrared radiation for Haripur earthquake, it has been observed that average temperature of earthquake preparation zone was convergent to highest level about 5–6 days before the earthquake. The average temperature also manifest decreased trend just 1–2 days before the earthquake and attains its normal value after the occurrence of earthquake. The variation of surface temperature from 1 to 5°C was observed and maximum radiative energy was shifted towards the epicenter during this period. The location of epicenter was found within the anomaly area. The observed thermal anomalies confirmed the association with studied earthquake. Moreover, if the record of normal temperature of a specific region is available, then in case of thermal anomaly, the occurrence of impending major earthquake may be assured.

## **Acknowledgements:**

The authors are thankful to Dr. Ishfaq Ahmad N.I. H.I. S.I, for his constant encouragement and patronization of the project. The authors are grateful to the SPAS division of SUPARCO for their assistance and help for the analysis of satellite data. The authors also acknowledge the MODIS Science Team, for making their data available to the user community.

## **References**

1. Al-Tamimi, M.H. and Abumurad K.M., 2001: Radon anomalies along faults in North of Jordan. *Radiat. Meas.*, 34, 397-400, doi: 10.1016/S1350-4487 (01) 00193-7.
2. Carreño, E., Capote, R., Yagüe, A., Tordesillas, J.M., López, M., Ardizzone, J., Suárez, A. Izquierdo, A; Tsige, M; Martinez, J. and Insua, J.M. y otros 2001. Observations of thermal anomaly associated to seismic activity from remote sensing. General Assembly of European Seismology Commission, Portugal, 265–269.
3. Chung, Y., 1985. Radon variation at Arrowhead and Murrieta springs: Continuous and discrete measurements. *PAGEOPH* 122, 294±308.
4. Chyi, L.L., Quick T.J., Yang T.F., and Chen C.H., 2005: Soil gas radon spectra and earthquakes. *Terr. Atmos. Ocean. Sci.*, 16, 763-774.

5. Fizzola, C., Pergola, N., Pietrapertosa, C., Tramutoli V., 2004. Robust satellite techniques for seismically active area monitoring: a sensitivity analysis on September 7, 1999 Athens's earthquake. *Phys. Chem. Earth* 29, 517–527.
6. Fu, C.C., Yang T.F., Walia V., and Chen C.H., 2005: Reconnaissance of soil gas composition over the buried fault and fracture zone in southern Taiwan. *Geochem. J.*, 39, 427-439, doi: 10.2343/geochemj.39.427.
7. Kumar, A., Singh S., Mahajan S., Bajwa B.S., Kalia R., and Dhar S., 2009: Earthquake precursory studies in Kangra valley of North West Himalayas, India, with special emphasis on radon emission. *Appl. Radiat. Isot.*, 67, 1904-1911, doi: 10.1016/j.apradiso.2009.05.016.
8. Lillesand, T.M and Kiefer, R.W., 2004. *Remote Sensing and Image Interpretation* 5th Edition, Johnwiley and sons USA pp-8.
9. Liu, H., 2002. Lecture notes on: Understanding thermal remote sensing data. In: *Remote sensing in geosciences*. Department of Geography, Texas A & M University.
10. Liu, Q., Ding, J., Cui C., 2000. Probable satellite thermal infrared anomaly before the Zhangbei M = 6.2 earthquake on January 10, 1998. *Acta Seismologica Sinica* 13 (2), 203– 209.
11. Ouzounov, D., Bryant, N., Logan, T., Pulinets, S., Taylor, P., 2006. Satellite thermal IR phenomena associated with some of the major earthquakes in 1999–2003. *Physics and Chemistry of the Earth* 31, 154–163.
12. Singh, S., A. Kumar, B.S. Bajwa, S. Mahajan, V. Kumar, and S. Dhar, 2010: Radon monitoring in soil gas and ground water for earthquake prediction studies in North West Himalayas, India. *Terr. Atmos. Ocean. Sci.*, 21, 685-695.
13. Singh, S., D.K. Sharma, S. Dhar, and S. S. Randhawa, 2006: Geological significance of soil gas radon: A case study of Nurpur area, district Kangra, Himachal Pradesh, India. *Radiat. Meas.*, 41, 482-485.
14. Teng, T., and SUN, L. F. (1986), Research on Groundwater Radon as a Fluid Phase Precursor to Earthquakes, *J. Geophys. Res.* 91, B12, 269-281.
15. Tramutoli, G., Di Bello, N., Pergola, S., 2001. Piscitelli: robust satellite techniques for remote sensing of seismically active areas. *Annals Geophys.* 44 (2), 295–312.
16. Tramutoli, V., Cuomo, V., Filizzola, C., Pergola, KhN., Pietrapertosa, C., 2005. Assessing the potential of thermal infrared satellite surveys for monitoring seismically active areas. The case of Kocaeli (Izmit) earthquake, August 17th, 1999. *Remote Sens. Environ.* 96 (3–4), 409– 426.
17. Tronin, A.A., Biagi, P.F., Molchanov, O.A., Khatkevich, Y.M., Gordeev,

- E.I., 2004. Temperature variations related to earthquakes from simultaneous observation at the ground stations and by satellites in Kamchatka area. *Phys. Chem. Earth* 29, 501–506.
18. Walia, V., T.C. Su, C.C. Fu, and T.F. Yang, 2005: Spatial variations of radon and helium concentrations in soil-gas across Shan-Chiao fault, northern Taiwan. *Radiat. Meas.*, 40, 513- 516, doi: 10.1016/j.radmeas.2005.04.011.
19. Walia, V., Virk H.S., and B.S. Bajwa, 2006: Radon precursory signals for some earthquakes of magnitude > 5 occurred in N-W Himalaya: An overview. *Pure Appl. Geophys.*, 163, 711- 721, doi: 10.1007/s00024-006-0044-z.
20. Yang, T.F., Walia V., Chyi L.L., Fu C.C., Chen C.H., Liu T.K., Song S.R., Lee C.Y., and Lee M., 2005: Variations of soil radon and thoron concentrations in a fault zone and prospective earthquakes in SW Taiwan. *Radiat. Meas.*, 40, 496-502, doi: 10.1016/j.radmeas. 2005.05.017.

## **ASSESSMENT OF SO<sub>2</sub> EMISSIONS FROM THREE COLOMBIAN ACTIVE VOLCANOES**

**<sup>1</sup>G. Garzon, Silva, B., <sup>2</sup>Narvaez, A., <sup>3</sup>Chacon, Z., <sup>4</sup>Galle, B.**

<sup>1,2,3</sup>*Colombian Geological Survey, Geohazards Division (Colombia),  
garzon@yandex.ru*

<sup>4</sup>*Chalmers University, Optical Remote Sensing Group (Sweden)*

### **Abstract**

*Thermodynamic and kinetic properties of magmas are central goal in volcanology researches. Gases play an important role to explain and understand volcanic activity. Relatively recent use of a novel optical remote sensor are a key to have gas data in real time for the surveillance of real state of volcanic activity and to take administrative and political decisions for mitigation and preparation to an eventual volcanic eruption. Examples of temporary sulphur dioxide emissions from three active Colombian volcanoes are presented, together with all cases of activity showed by each volcano since 2007 till 2012. As andesite volcanoes, they show properties to seal volcanic chimney and facilitate pressurization within final stages of explosive eruptions.*

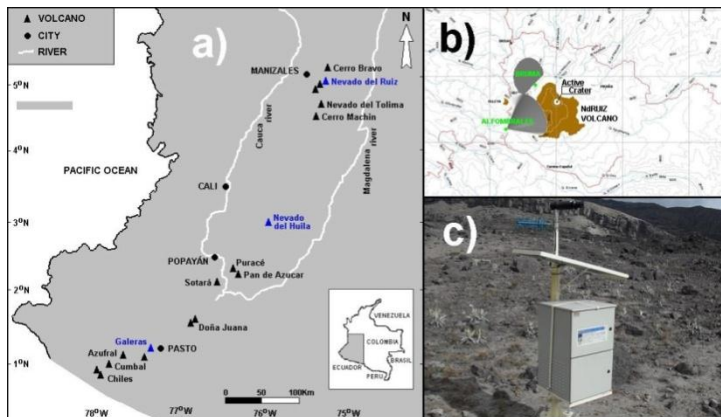
## **Introduction**

Faster and easier gases may transfer energy, compared to the other classical states of matter. Transport of gases from the Earth's interior play an important role in geodynamic processes, including volcanic eruptions, plate tectonic motions and earthquakes. All around the world, volcano surveillance includes systematic evaluation of various types of geophysical, physicochemical and geological data from processes taking place in the interior and surface of studied volcanic edifice. All data have to be interpreted and synthesized in a report as a guide to anticipate what may happen next, given this way useful information to local authorities for preparation and mitigation purposes. Instruments and networks used for volcano surveillance are of different types, costs, effectiveness and sophistications: some instruments are of digital type transmitting data in near real time to observatory toolbox, some have to be installed as temporary networks, whereas some others have to be used as portable instruments in the volcanic edifice to make *in situ* measurements. Volcano surveillance in Colombia was formally initiated just after reactivation of Nevado del Ruiz volcano was recognized in 1985. On November 13<sup>th</sup>, 1985 at 21:09 Nevado del Ruiz volcano erupted dacitic tephra more than 30 kilometers into the atmosphere (Naranjo et al., 1986). This eruption produced pyroclastic flows that melted summit glaciers and snow, generating four thick lahars that raced down river valleys on the volcano's flanks. Lahars, formed of water, ice, pumice, and other rocks, mixed with clay as they travelled down the volcano's flanks. One of the lahars virtually erased the small Armero town (Tolima department), which lay in Lagunilla river valley. Only one quarter of its 28,700 inhabitants survived. A second lahar, which descended through the valley of Chinchina river, killed about 1,800 people and destroyed about 400 homes in Chinchina town (Caldas department). In total, over 23,000 people were killed and approximately 5,000 were injured. More than 5,000 homes were destroyed. Armero tragedy, as the event came to be known, was the second-deadliest volcanic disaster in the 20<sup>th</sup> century, being surpassed only by the 1902 eruption of Mount Pelée, and is the fourth-deadliest volcanic eruption in recorded history (Huggel et al., 2007). As of 2012 the Colombian Geological Survey (former INGEOMINAS, [www.ingominas.gov.co](http://www.ingominas.gov.co)) has three volcanological observatories, looking for the internal processes of fourteen igneous active volcanoes in Colombian territory (Figure 1a). Seismic, ground deformation, gas and electromagnetic monitoring are the main activities carried out in Colombian observatories. Permanent networks are installed at Colombian volcanoes including three NOVAC gas stations installed in 2007 at Galeras, two NOVAC stations at Nevado del Huila and two NOVAC

stations in 2009 at Nevado del Ruiz volcanoes, from which data are transmitted to each volcanological observatory.

### Novac project

NOVAC ([www.novac-project.eu](http://www.novac-project.eu)) is the *Network for Observation of Volcanic and Atmospheric Change* with stations in four continents for the quantitative measurement of volcanic gas emissions by UV absorption spectroscopy making use of a novel type of instrument, the scanning dual-beam miniature – Differential Optical Absorption Spectrometer (mini-DOAS) developed within the EU-project DORSIVA (Galle et al., 2006). NOVAC was conceived with the purpose to measure gases in real time from natural environments like volcanoes with an optical remote sensor (Galle et al., 2002), as an important attempt to apply these gas data to validate satellite data and specially to evaluate their impact to atmosphere and climate change.



**Fig. 1. a) Location of colombian active volcanoes (Northern Andes);  
b) Scandoas configuration at Nevado del Ruiz volcano;  
c) Scandoas system installed at Nevado del Ruiz volcano.**

In particular, instruments are providing new parameters in the toolbox of the observatories for:

- 1) volcano hazard evaluation;
- 2) gas emission estimates; and,
- 3) physicochemical research on the local scale.

Data are exploited for other scientific purposes, such like:

- 1) regional and global estimates of volcanic gas emissions;
- 2) large scale volcanic correlations;

- 3) studies of climate change;
- 4) studies of stratospheric ozone depletion; and,
- 5) validation of gas data from satellites.

As of 2012 NOVAC encompasses 24 volcanoes in four continents, including some of the most active and strongest degassing volcanoes in the world. Five universities and 10 institutes of Europa, Africa and the Americas are partners of the NOVAC consortium. Generated NOVAC data is now available for global and regional networks, such as: 1) Association of Latin- American Volcano Observatories - ALVO; 2) Network for the Detection of Stratospheric Changes – NDSC; and, 3) Inter-American Network for Atmospheric and Biospheric Studies – IANABIS.

### **Instruments and networks**

Measurements of SO<sub>2</sub> molecules flying in the volcanic plume from fumaroles at three colombian volcanoes are made using an ultraviolet spectrometer and differential optical absorption spectroscopy – DOAS (Platt, U., 1994) retrieval methods. DOAS is a technique used for continuous measurements of atmospheric gases, based on the spectral analysis of the differential absorption by molecules in the ultraviolet and visible part of the spectrum. The broader extinction of ultraviolet light due to other processes such as scattering on air molecules and aerosol particles is cancelled during DOAS retrieval and thus not taken into account (Grutter et al., 2008). Measurements of volcanic plumes around colombian active volcanoes are carried out in a car or helicopter in motion in a weekly periodicity using a NOVAC mobiledoas system; and, each five minutes during the day from NOVAC scandoas networks located at distances of 5 to 8 Km from active craters of Galeras, Nevado del Huila and Nevado del Ruiz volcanoes (Garzon et al., 2008). All spectra is transmitted using antennas and freewave radios, from stations to the observatory toolbox for later processing, evaluation and comparison with seismic, ground deformation and electromagnetic data. At Galeras volcano (01° 13' N, 77° 21' W, 4276 m.a.s.l.) in 2007 was configured a network of three scandoas type I NOVAC instruments; around Nevado del Huila volcano (02° 55' N, 76° 03' W, 5364 m.a.s.l.) were installed two permanent stations; and, in November 2009 were installed two stations close the main crater of Nevado del Ruiz volcano (04° 53' N, 75° 19' W, 5321 m.a.s.l.) as is shown instruments configuration in Fig. 01b. Each scandoas system (Fig. 01c) consist of a pointing telescope fiber-coupled to a S2000 spectrometer from Ocean Optics Inc. Ultraviolet light from the sun, scattered by aerosols and molecules in the atmosphere, is collected by means of a telescope with a quartz lens defining a field of view of 8 mrad. The



telescope is attached to a scanning device consisting of a mirror mounted on a computer-controlled stepper-motor, providing a means to scan the field of view of the instrument over  $180^{\circ}$ . The collected light is transferred from the telescope to the spectrometer through an optical quartz fiber. The spectrometer uses a 2400 lines/mm grating, which combined with a  $50\ \mu\text{m}$  slit provides an optical resolution of approximately 0.6 nm over the wavelength range of 280-420 nm. A band-pass filter (Hoya U330), blocking visible light with wavelength longer than 360 nm, is installed in the telescope, approximately 2 mm behind the lens, with the purpose of reducing spectrometer stray light. In an ideal measurement, the instrument is located under the volcanic plume, and scans are made from horizon to horizon, in a vertical plane or along a conical surface approximately perpendicular to the wind direction. Typically a 3 seconds integration time is used, with a spectrum collected every  $3.6^{\circ}$ , providing a full flux measurement every 5 minutes (Galle et al., 2010).

### **Results and discussions Galeras volcano**

Galeras last activity cycle started with a first episode on August 11<sup>th</sup> 2004 at 23:49 followed by a second event after less than one hour on August 12<sup>th</sup> 2004 at 00:02 erupting ash volumen of about 1.2 million cubic meters. *Pasto Volcanological and Seismological Observatory* reported ([http://intranet.ingominas.gov.co/pasto/Boletines\\_mensuales](http://intranet.ingominas.gov.co/pasto/Boletines_mensuales)) an emplaced dome in the main crater at Galeras volcano with a volumen of 700,000 cubic meters, which was observed from helicopter on January 13<sup>th</sup> 2006. Fig. 02 shows sulphur dioxide fluxes measured at Galeras volcano since November 2007 till July 2012, where as a red square is indicated an ash eruption registered on January 17<sup>th</sup> 2008 followed by an SO<sub>2</sub> increase started the second semester of 2008 reaching values up to of 13,600 tonnes per day. Increases of sulphur dioxide fluxes from fumaroles at Galeras volcano in 2008 can be explained as a magma intrusion based on the relative high solubility of sulphur gases in the volume of Galeras magmas. Movement from the depth to the surface of relative high volume of Galeras magma will facilitate sulphur dioxide exsolution with decrease of lithostatic pressure reaching the surface with more and more open fractured conditions. Since February 14<sup>th</sup> till January 2<sup>nd</sup> 2010 ten explosive eruptions destroyed the dome. Just after the high SO<sub>2</sub> emissions in 2008, was followed a sealing process in Galeras, which reduced gas flows into the atmosphere and therefore increased the internal pressurization of the volcanic chimney. Product of

this high pressurization in the Galeras conduits, were the consecutive eruptions since 2009.

### Nevado del Huila volcano

Nevado del Huila volcano after centuries of dormant state, started its activity on February 2007. Fig. 03 shows sulphur dioxide emissions calculated using vertical column densities measured with a NOVAC mobile-DOAS system together with WRF (Weather Research & Forecasting) wind speed model. Since October 1<sup>st</sup> 2008 till September 30<sup>th</sup> 2009 wind speed at the top of Nevado del Huila volcano was nearly 10 m/s; whereas SO<sub>2</sub> emissions from Nevado del Huila volcano varied from 12,760 tonnes per day on October 28<sup>th</sup> 2008 to 416 tonnes per day on July 28<sup>th</sup> 2009. Higher sulphur dioxide emission was measured when magma intrusion process finished with a first dome extruded, and lowest sulphur dioxide was measured just when a second dome extruded on the SW side of the crater as was reported by *Popayan Volcanological Observatory* (<http://www.ingominas.gov.co/Popayan/Publicaciones/Informes-tecnicos.aspx>).

First three months of 2010 was characterized by a relative relaxation of the system with SO<sub>2</sub> emissions close to 2,000 tonnes per day with wind speed at the top of Nevado del Huila volcano of around 8.0 m/s.

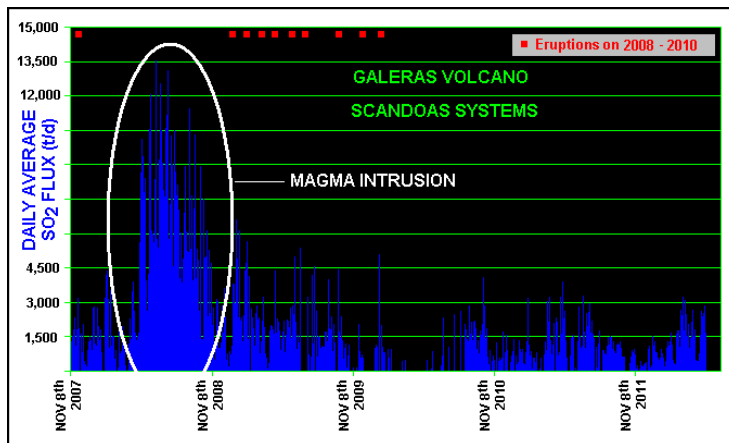


Fig. 2. Sulphur dioxide fluxes and eruptions at Galeras volcano (2005-2012).

## **Nevado del Ruiz volcano**

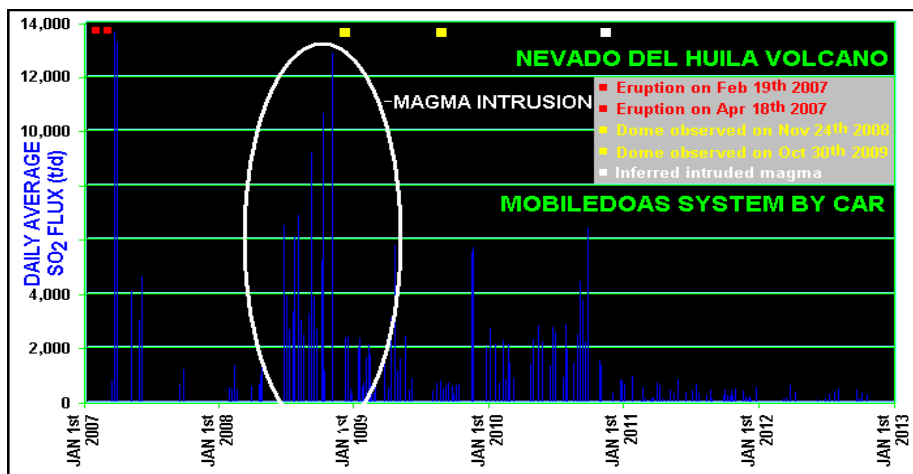
First gas data from Nevado del Ruiz volcano using NOVAC technology were telemetered to the toolbox of *Manizales Volcanological Observatory* on November 30<sup>th</sup> 2009. As is seen in Fig. 04, sulphur dioxide fluxes from Nevado del Ruiz volcano were below 250 tonnes per day since the installations of scandoas systems till finishing second semester of 2010. On October 8<sup>th</sup> 2010 were registered a daily flux of 462 tonnes of sulphur dioxide and this behaviour was conservative with fluxes below 668 tonnes per day for more than one year. Nevado del Ruiz volcano began to show signs of increased activity in February 2012. A larger than normal steam plume was seen issuing on many days from Nevado del Ruiz's main crater, while instruments began to show increased gas flux and seismicity. Scientists flying over the volcano noted fresh ash on the east flank of the volcano near the crater. The deposits were likely from an eruption on February 22<sup>th</sup> 2012 (probably phreatic). On February 23<sup>th</sup> 2012 a small ash plume was seen rising from the Nevado del Ruiz's crater (<http://www.ingominas.gov.co/Manizales/Publicaciones/Informes-tecnicos.aspx>).

On March 31<sup>st</sup> 2012 the Nevado's National Natural Park authority decided to shut the reserve to all visitors, following the increment of the threat level from yellow to orange. Sulphur dioxide emissions increases were recorded by scientific instruments until the June 30<sup>th</sup> 2012 ash eruption, which literally blocked access of sunlight to the solar panels that feed electronics at gas stations. No more continuous gas data were transmitted to the Manizales Observatory.

Fig. 05 was built by adding SO<sub>2</sub> fluxes emitting from Nevado del Ruiz volcano, where four slopes were observed: 1) Since November 2009 till September 2010; 2) Since September 2010 till March 2012; 3) Since March 2012 till May 2012; 4) Since May 2012.

A first temporary stage (I) was characterized by a relative constant gas emission. Notable in this period was changes as up to 400  $\mu$ rad registered by electronic tiltmeters installed in the Nevado del Ruiz's flanks (Ordoñez, M. personal communication) by the Ground Deformation group of Manizales Volcanological Observatory. A second temporal stage (II) was accompanied by increases as about 400 tonnes per day of sulphur dioxide gas emissions from the volcano, and increases of volcano-tectonic seismicity as was reported by the *Manizales Observatory*. High increases as about 2,400 tonnes per day of sulphur dioxide fluxes was observed in the third temporal stage (III), which was characterized by the first ash emissions in February-March 2012.

Increases in sulphur dioxide fluxes above 6,000 tonnes per day, accompanied by explosive eruption on June 30<sup>th</sup> 2012 started the four activity stage (IV) of Nevado del Ruiz volcano. Activity stage (I) at Nevado del Ruiz volcano was perhaps characterized by ground inflation of the edifice as the most important process for more than one year, which partially fractured conduit rocks observed by volcano-tectonic seismic signals and started increases of gas fluxes in the activity stage (II). Activity stage (III) was dominated by magma intrusion processes, accompanied by high sulphur dioxide fluxes and a first ash emissions into atmosphere. Activity stage (IV) is the present activity characterized with frequent ash eruptions since June 2012. From Galeras, Nevado del Huila and Nevado del Ruiz's SO<sub>2</sub> fluxes in the period since 2007 till 2012, increases of more than 6,000 tonnes per day have been accompanied by magma intrusion. Later extruded domes in the craters were observed and explosive eruptions were registered. Processes in which magma is transported by depressurization close the surface below active crater, but never crystallize as a dome in the crater is a possibility, playing a role as a plug.



**Fig. 3. Sulphur dioxide fluxes from Nevado del Huila volcano (2007-2012).**

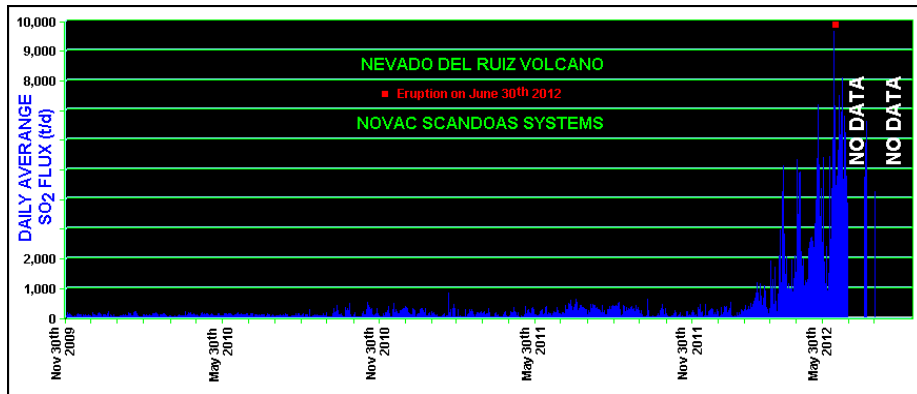


Fig. 4. Sulphur dioxide fluxes from Nevado del Ruiz volcano (2009-2012)

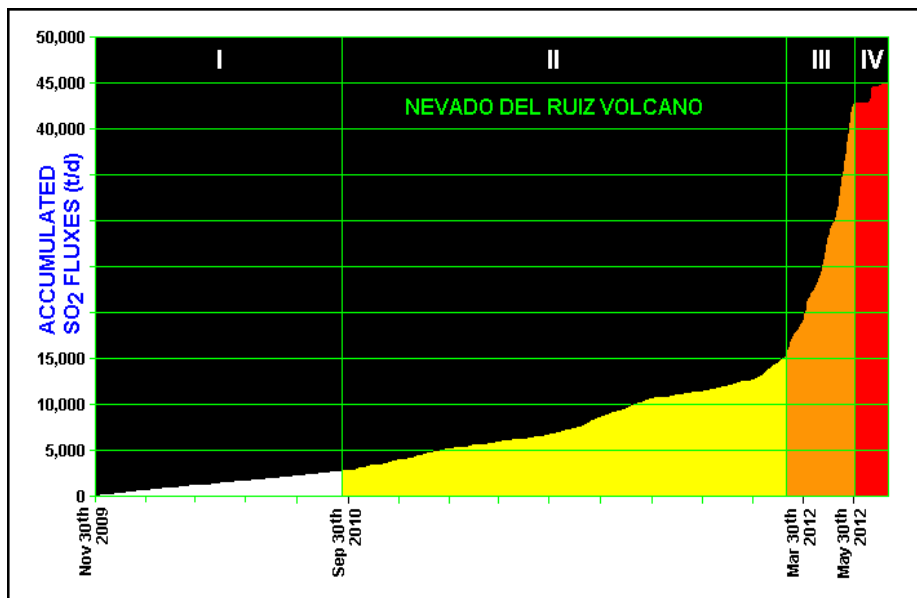


Fig. 5. Summary of sulphur dioxide fluxes from Nevado del Ruiz volcano (2009-2012)

From cited examples, decrease of sulphur dioxide fluxes can be responsible of two different processes: a pressurization process as a result of sealing of chimney's conduits which may finalize with an explosive eruption or a relaxation process as is observed in the present activity stage of Nevado del Huila volcano after 2010.

## Conclusions

Since 2007 till 2012 fourteen Colombian volcanoes are active, at which three have highest activity, including dome formation as magma flow from the depth, and dome destruction producing explosive eruptions. Optical remote sensors are playing a key role for sulphur dioxide monitoring in real time. Increases in sulphur dioxide fluxes positively correlate with magma intrusion at Galeras, Nevado del Huila and Nevado del Ruiz volcanoes. Decreases in sulphur dioxide fluxes can take place during pressurization or relaxation processes at Galeras, Nevado del Huila and Nevado del Ruiz volcanoes. Special protection for instruments installed close active volcanoes must be developed, in order to ensure complete data transport to volcanological observatories during volcanic crisis.

## References

1. Galle, B., Delgado, H., Garzon, G., Vogel, L., Platt, U. 2010. Final scientific report EU-Project NOVAC, Chalmers Univ. of Tecnol., Gothenburg, Sweden, 102pp.
2. Galle, B., Platt, U., Oppenheimer, C., Millan, M., Alonso, L., Chen, D. 2006. Final scientific report on EU-Project DORSIVA, Rep. 26051, Chalmers Univ. Of Technol., Gothenburg, Sweden.
3. Galle, B., Oppenheimer, C., Geyer, A., McGonigle, A., Edmonds, M., Horrocks, L. 2002. A miniaturised ultraviolet spectrometer for remote sensing of SO<sub>2</sub> fluxes: a new tool for volcano surveillance. *J. Volcanol. Geotherm. Res.*, 119, 241-254.
4. Garzon, G., Santacoloma, C., Galle, B., Solarte, E. 2008. Estrategias de medición de gases volcánicos en Colombia, utilizando sensores ópticos remotos. *Revista Bistua, Universidad de Pamplona*, 6(2), 32-40.
5. Grutter, M., Basaldud, R., Rivera, C., Harig, R., Junkerman, W., Caetano, E., Delgado
6. H. 2008. SO<sub>2</sub> emissions from Popocatepetl volcano: emission rates and plume imaging using optical remote sensing techniques. *Atmos. Chem. Phys.*, 8, 6655-6663.
7. Huggel, C., Ceballos, J.L., Pulgarin, B., Ramirez, J., Thouret, J-C. 2007. Review and reassessment of hazards owing to volcano-glacier interactions in Colombia. *Annals of Glaciology, The International Glaciology Society*, 45, 128-136.
8. doi:10.3189/172756407782282408.
9. Naranjo, J.L., Siggurdsson, H., Carey, S.N., Fritz, W. 1986. Eruption of the Nevado del Ruiz Volcano, Colombia on 13 November 1985: Tephra Fall and Lahars. *Science*, 233(4767), 991-993. doi:10.1126/science.233.4767.961.
10. Platt, U. 1994. Differential optical absorption spectroscopy. In: Sigirst, M. (Ed.), *Air monitoring by spectroscopic techniques*, John Wiley & Sons, Hoboken, N.J., 27-84.
11. [http://intranet.ingeoformas.gov.co/pasto/Boletines\\_mensuales](http://intranet.ingeoformas.gov.co/pasto/Boletines_mensuales)
12. <http://www.ingeoformas.gov.co/Popayan/Publicaciones/Informes-tecnicos.aspx>
13. <http://www.ingeoformas.gov.co/Manizales/Publicaciones/Informes-tecnicos.aspx>

## **DISPLAYING OF THE FIELDS INDUCED BY A FAULT IN AN INTERACTIVE MODE: APPLICATION TO THE EL-ASNAM EARTHQUAKE (ALGERIA, 10/10/1980, M=7.2)**

**Kariche Jugurtha<sup>1,2</sup> , Boughacha Mohamed Salah<sup>1</sup>**

<sup>1</sup>*Université des Sciences et de la Technologie Houari Boumédiène, FSTGAT  
Department of Geophysics, BP 32, 16120, El Alia, Bab Ezzouar, Algiers, Algeria,  
m\_sboughacha@yahoo.com,*

<sup>2</sup>*Centre de Recherche en Astronomie, Astrophysique et Géophysique, CRAAG, BP 63,  
Algiers, Algeria,jkariche@gmail.com*

### **1 introduction**

The theory of dislocation was used by Steketee [15] to compute the static change caused by fault movement. In his turn, Chinnery [6] used this work for calculating the field of displacement by analytical expression. Okada [12] generalized these expressions to deduce those of deformation field. In this work, we use the Okada's code DC3D [12] to study the response of a fault in terms of displacement, strain, and stress. The programme we present allows computing the displacements and deformation related to a single or a serial faults. The stress field is given by Hooke's law. It is interactive, written in Fortran 77 language and compiled under Linux platform, using Shell scripts. As input, it is required the earthquake parameters; the output consists of the displacement, strain and stress fields. The models were constrained by geodetic measurements (Ruegg et al. [14], Meghraoui and Doumaz [11]). An example of calculation of the generalized shape parameter from Angelier [2], which represent the tectonic regime of the area of study, is also presented.

### **1. Fault Modeling**

Modeling includes examples of hypothetical faults and also an application on a real case (10/10/1980 El Asnam earthquake, M =7.2). We present the steps of modeling in order to illustrate how the programme runs.

#### **2.1. Major Routines**

The programme includes two major routines.

##### *2.1.1 Routine 1*

It requires the sources parameters: strike, dip, rake, length, width, depth, and geographical coordinates of the upper middle point of the fault.

##### *2.1.2 Routine 2*

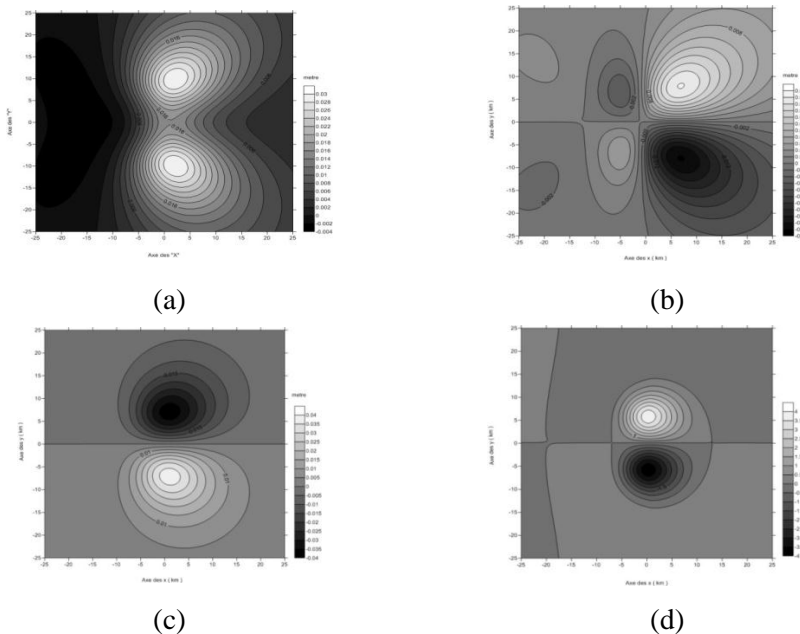
It uses the Okada's subroutine in order to compute the displacement, strain. Stress fields are deduced from Hooke's law. The calculations are made at the nodes of a 0.5x0.5 km horizontal grid, at a given depth.

## 2.2. Validation of the programme

The programme is validated through published examples.

### 2.2.1 Test 1

It is given by Okada [12] and consists of a strike-slip fault, located at 6 km depth, with dip = 40°, length L=12 km, width W=8 km, and a uniform slip U=50 cm. The fields are calculated on the surface (Fig.1).



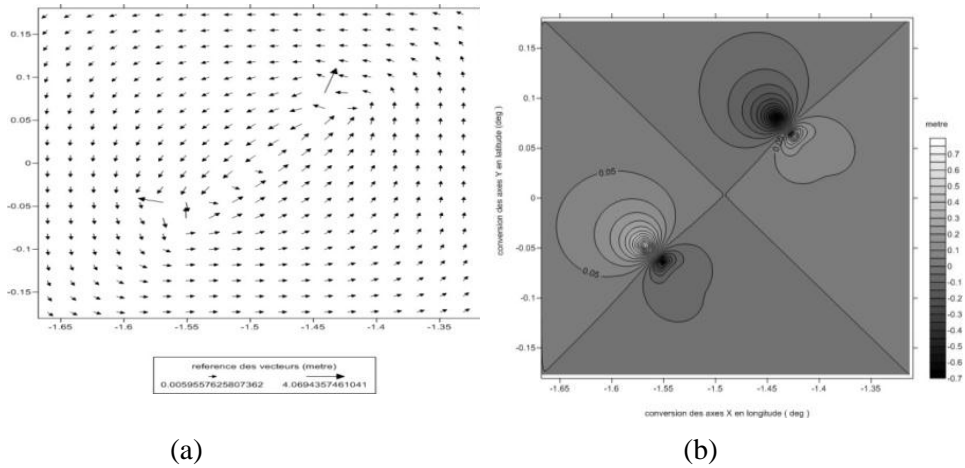
**Fig.1. Displaying of the displacement field calculated on the surface, compared with that obtained by Okada [12]: a) horizontal component  $U_x$ , b) horizontal component  $U_y$ , c) vertical component  $U_z$ , d) dilatation ( $10^{-6}$ )**

### 2.2.2 Test 2

It is provided by Boughacha [5] and consists of a rectangular fault with (dip, strike) = (60°, 45°), dimension (20 X 10 km) and a dislocation of 1 meter.

Like in the first test, the fields are computed on the surface. It is displayed in vector mode for the horizontal component of displacement, and contouring map for the vertical component of displacement (Fig.2).



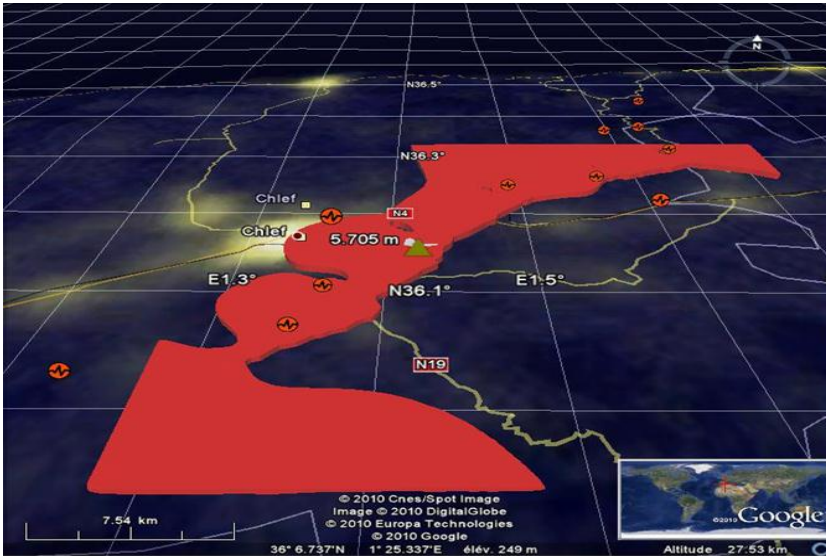


**Fig.2. Displaying of the displacement field calculated on the surface, compared with that obtained by Boughacha [5]: a) Horizontal component of displacement in vector mode, b) Contour map of vertical component**

Table 1

**Fault panel data for the model in this study**

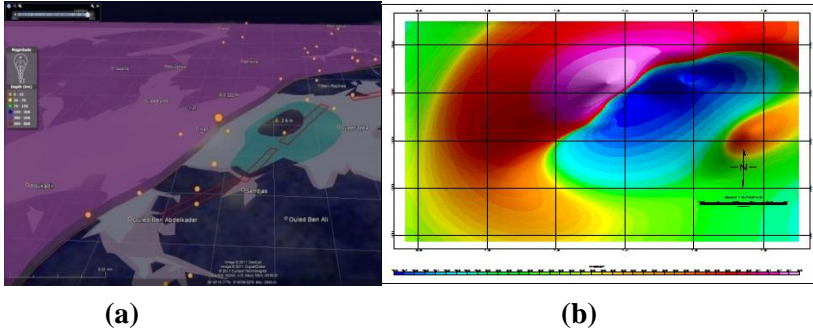
Panel	Coordinates (UTM, zone 31)		Depth (km)	Dimensions (km)		Orientation		Fault Slip (m)	
	X (km)	Y (km)		L	W	Dip (°)	Strike (°)	Sinistral	Reverse
1	353.19	4001.46	11.28	10.0	10.0	70	57.5	1.0	1.0
2	357.03	4007.12	11.26	6.0	12.5	60	44.1	2.0	3.0
3	362.60	4015.03	12.14	10.0	14.9	54	40.5	1.0	8.0
4	375.56	4024.12	12.14	8.0	13.0	54	67.0	0.0	3.0



**Fig.3. Vertical co-seismic displacement induced by the El Asnam earthquake (Algeria, 10/10/1980, M=7.2): the computed field is represented by red color (positive). The green triangle indicates the displacement observed (5.15 m) by Ruegg et al [14], in agreement with that calculated by our model (5.71 m)**

### 2.2.3 Test 3

It refers to the model of Ruegg et al [14] related to the El Asnam (Algeria) earthquake of 10 October 1980. This model consists of 4 panels (Table 1+ Fig.3) illustrating the vertical movement induced by this earthquake. The maximum observed and computed values are respectively 5.71 and 5.15 m, consolidating the validity of the program. Finally, we can say that the results of all tests are concordant. Fig.4 shows the values of displacement for the same model (Ruegg et al [14]) at 5 km depth. We represent the same field in two visualization modes: the *Google –Earth* mode in which the maximum value of displacement is indicated by green triangles, and the *Shaded-relief* mode in which the maximum value is indicated by purple (positive value) and blue (negative values), respectively. We observe that the values of the displacement decrease in depth (the green triangles show a maximum value of 0.22 m and a minimum value of -2.60 m). The positive values of displacement are represented by purple color in *Google –Earth* mode (Fig.4-a) and purple-red color in *Shaded-relief* mode (Fig.4-b).



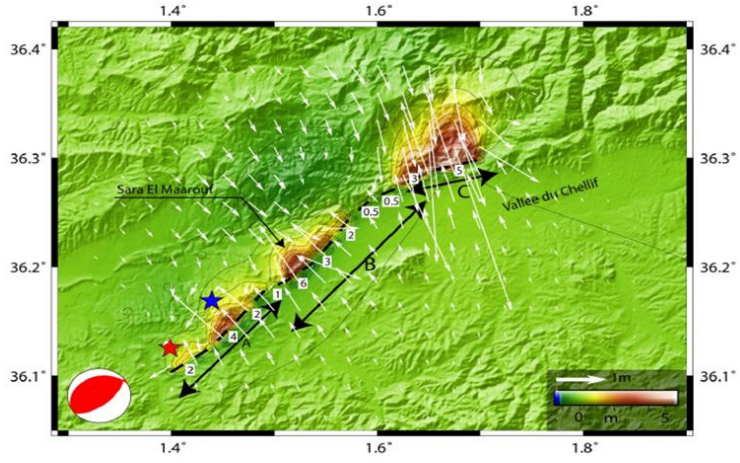
**Fig.4. Vertical co-seismic displacement induced by the El Asnam earthquake at km depth in two modes:**

**a) the Google-Earth mode in which the computed field is represented by purple color (positive).**

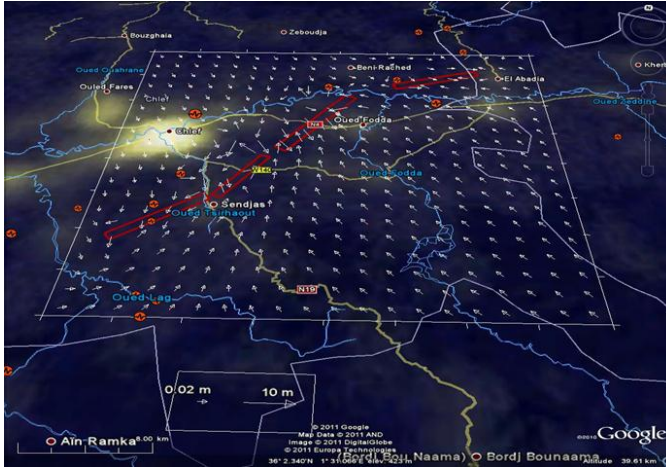
**The green triangles indicate the maximum and the minimum displacement observed (0.22 m and  $-2.6$  m); the red rectangle represents the fault trace; the orange circles indicate the USGS aftershock location.**

**b) the Shaded-relief mode representing the same computed field. We assign purple and blue colors to the maximum and the minimum, respectively**

The horizontal displacement at the surface of the El Asnam earthquake is represented in vector mode (Fig.5–b). Our computing method is constrained by the computing method based on the Poly3D software used for the same earthquake by Bellabes [3] (Fig.5-a). Our results are concordant with those found by Bellabes [3].



**(a)**



(b)

**Fig.5. Horizontal displacement computed from: a) the Bellabes modeling [3] based on Poly3D software: the A, B, and C sections show the different panels used; the beach ball represents the focal mechanism of the El Asnam earthquake. b) Our modeling: the red rectangles represent the trace of fault; the result is in agreement with that calculated from the Poly3D software [3]**

### 3 Displaying The Tectonic Regime of The El Asnam Earthquake

The Angelier's shape parameter  $\Phi$  [2] is a reduction of the general tensor  $T$ , deduced from the diagonal form of the stress tensor (principal axes), using the following steps.

- 1 – We extract  $\sigma_3$  from the diagonal elements
- 2 – We divide the diagonal tensor by the quantity  $(\sigma_1 - \sigma_3)$  which is called *the maximum stress difference*
- 3 – Finally, we express  $T$  in the following form

$$T = k_1 I + K_2 T_\phi$$

where  $k_1 = \sigma_3$ ,  $I$  is the identity matrix,  $k_2 = \sigma_1 - \sigma_3$ ,  $T_\phi$  is the matrix reduction parameter, given by

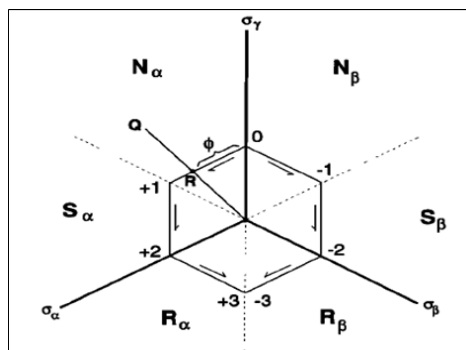
$$T_\phi = \begin{bmatrix} 1 & 0 & 0 \\ 0 & \phi & 0 \\ 0 & 0 & 0 \end{bmatrix}$$

such as

$$\Phi = (\sigma_2 - \sigma_3) / (\sigma_1 - \sigma_3)$$

We can now write the generalized shape parameter including information about

- the shape of stress tensor
  - and
  - the vertical axis of principal stress
- enabling to have the fault type. We must define a coordinate system  $(\sigma_\alpha, \sigma_\beta, \sigma_\gamma)$  in the stress space enabling to view geometrically the parameter  $\Phi$  (fig.6).



**Fig.6. Geometry of space stress: view from below. The Anderson fault parameter,  $A_\phi$ , is the distance along the hexagon from the projection of the  $\sigma_\gamma$  axis. The numbers at the corners indicate the values of  $A_\phi$ (Simpson [16])**

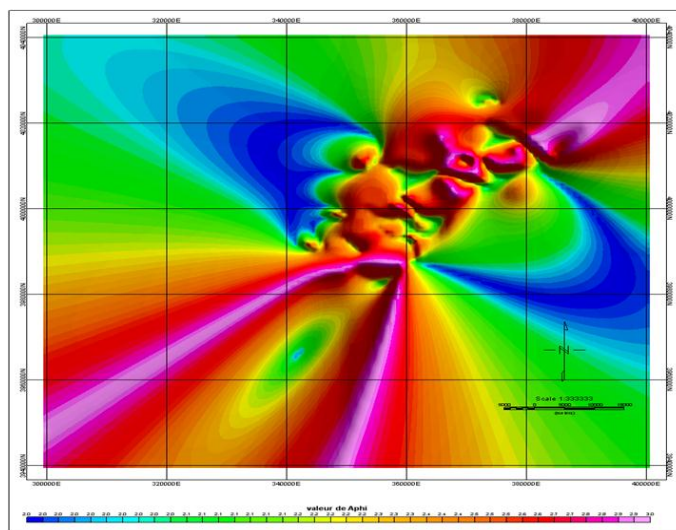
The relation between  $\phi$  and  $A_\phi$  is given in the following manner: if the type of fault is normal, strike-slip or reverse, then we assign the numbers  $n = 0, 1, \text{ and } 2$ , respectively. Following (Simpson [16]), this relation takes the form:

$$A_\phi = (n + 0.5) + (-1)^n (\phi - 0.5)$$

$A_\phi$  varies from 0 to 1 for a normal fault, from 1 to 2 for a strike-slip fault, and from 2 to 3 for a reverse fault (Fig. 6). An application of  $A_\phi$  is made for the El Asnam region (Algeria) through Fig.7, using the parameters of the 1980 earthquake, confirming the compressive regime in this area.

## Conclusion

The present software can be used to compute the elastic fields induced by one or more faults in a very short period of time. Input consists of fault parameters; output consists of elastic fields (displacement, strain and stress). It is interactive and accessible to everyone, for both academic and purposes research. It can also be used for more complex problems such as GPS data inversion, or solving problems related to stress tectonic regime, by using the  $A_\phi$  function.



**Fig.7. Fault type parameter of the El Asnam region.**

$A_\varphi$  values are ranged between 2 and 3 confirming the compressive state of this area

## References

1. Anderson E.M. (1951), The dynamics of faulting and dyke formation with application to Britain, 2<sup>nd</sup> Ed, Oliver and Boyd, Edinburgh, 206 p.
2. Angelier J. (1979), Determination of the mean principal stresses for a given fault population, *Tectonophysics*, T17-T26.
3. Bellabes S. (2008), Caractérisation de la déformation active par l'Interférométrie Radar (InSAR): Failles sismiques aveugles et cachées de l'Atlas Tellien (Algérie) et du Rif (Maroc) le long de la limite des plaques Afrique-Eurasie, PhD Thesis, University of Louis Pasteur-Strasbourg I., Strasbourg, 195 p.
4. Bezzeghoud M., Dimitrov D., Ruegg J.C., and Lammali K. (1995), Faulting mechanism of the El Asnam (Algeria) 1954 and 1980 earthquakes from modelling of vertical movements. *Tectonophysics*, p.249 – 266.
5. Boughacha M.S. (2005), Analyse de la sismicité de l'Algérie. Application à l'établissement des cartes des IMO et  $\Delta CFF$ , PhD. Thesis, University of Bab Ezzouar, USTHB, Algiers, 289 p.
6. Chinnery M.A. (1963), The stress changes that accompany strike-slip faulting, *Bull. Seism. Soc. Am.* 53 5, p. 921-932.
7. Erickson L.L. (1986), A three-dimensional dislocation program with applications to faulting in the Earth, M.Sc. Thesis, Stanford University, Stanford, California, 167 p.
8. Healy D., Yielding G. and Kusznir N. (2004), Fracture prediction for the 1980 El Asnam, Algeria earthquake via elastic dislocation modelling. *Tectonics*, 23 (6), TC6005.
9. Jaeger J., Cooke N.G.W. and Zimmerman R. (2006), *Fundamentals of rock mechanics*, fourth edition, Blackwell Publishing, 509 p.

10. Mahsas A. (2009), Variation de la contrainte de Coulomb: Cas de l'Algérie, Magister. Thesis, University of Bab Ezzouar, USTHB, Algiers, 107 p.
11. **Meghraoui M.** and Doumaz F. (1996), Earthquake-induced flooding and paleoseismicity of the El Asnam (Algeria) fault-related fold, *J Geophys. Res.*, 101, 17617-17644.
12. Okada Y. (1992) internal deformation due to shear and tensile faults in a half space: *Bulletin of The Seismological Society of America*, v. 82, p. 1018-1040.
13. Shearer P.M. (2009), *Introduction to Seismology: Second Edition*, Cambridge University Press, 412 p.
14. Ruegg J.C., Kasser M., Tarantola A., Lepine J. C and Chouikrat B. (1982), Deformations associated with the El Asnam earthquake of 10 October 1980: Geodetic determination of vertical and horizontal movements, *Bull. Seismo. Soc. Am.*, 72, p. 2227 – 2244.
15. Steketee J.A. (1958), On Volterra's dislocation in a semi-infinite elastic medium, *Can. J. Phys.* 36, p.192-205.
16. Simpson R.W. (1997), Quantifying Anderson's fault types, *journal of geophysical research*, vol.102, b.8, p. 17, 909-17, 919.
17. Volterra V. (1907), Sur l'équilibre des corps élastiques multiplement connexes. *Annales Scientifiques de l'Ecole Normale Supérieure*, 24(3), 1907.5, 6, p. 401-517.

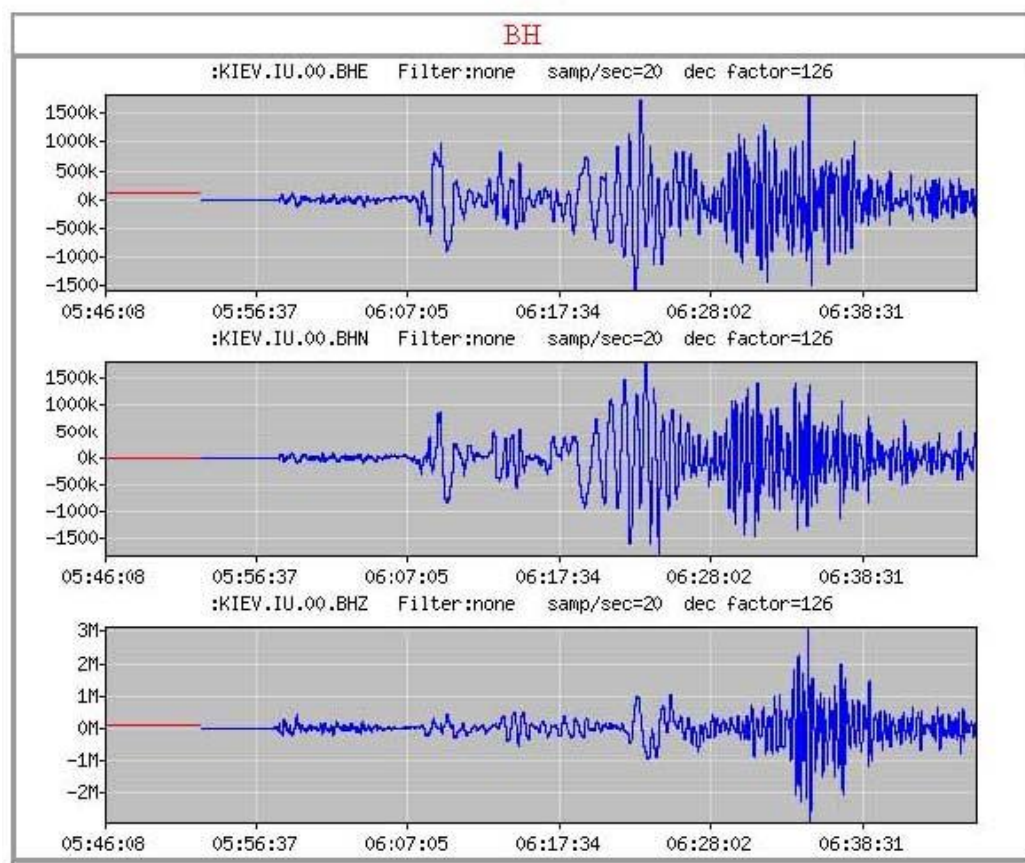
## **SEISMICITY AND SEISMIC PROTECTION IN UKRAINE**

**Vitaly Starostenko<sup>1</sup>, Olexander Kendzera<sup>2</sup>, Olga Legostaeva<sup>3</sup>,  
Liudmila Farfuliak<sup>4</sup>**

*<sup>1,2,3</sup>The IGF NAS of Ukraine, <sup>4</sup>Institute of Geophysics  
of National Academy of Sciences of Ukraine  
vstar@igph.kiev.ua, kendzera@igph.kiev.ua,  
olgal@igph.kiev.ua, myronivska@list.ru*

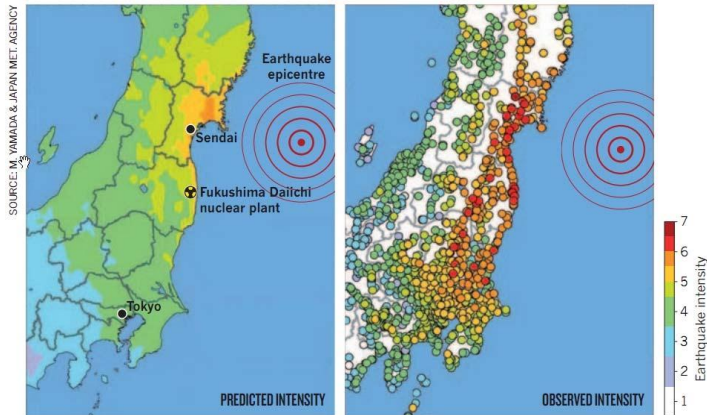
Experience of catastrophic earthquakes that occurred one after another in Haiti 12/01/2010, with Mw = 7.0, in Chile 01/12/2010 with Mw = 7.0 and in Japan 11/03/2011, with Mw = 9.0, makes seismologists to re-evaluate their effects and to compare the situation with the seismic protection in these countries with the situation in Ukraine. These earthquakes are confined to the powerful seismically active zone of the planet. Earthquake 11/03/2011 in Japan, with Mw = 9.0 is one of the biggest destructive event at the last time not only in Japan but in the world. Seismologists have to pay attention of this global disaster. The seismogram of this earthquake that occurred

at 05:46:23 UTC Near East Coast Honshu and was recorded at Kiev IRIS station (Kiev, Ukraine) is shown in Fig. 1. Unfortunately, as seen from a comparison of two maps, presented in Fig. 2 of Maximum seismic hazard (MSH) map of the territory near east coast Honshu [1], the intensity of seismic manifestations of the earthquake was, in fact, higher than predicted by seismologists to map of the Japan MSH. We have to note, that Japan catastrophic earthquake was happened in the world active tectonic belt associated with the zone of collision of the thin Pacific Plate with the Eurasian Plate, as seen in Fig. 3, where Japanese seismologists estimated rupture zone and mechanism of earthquake preparation [2, 3].

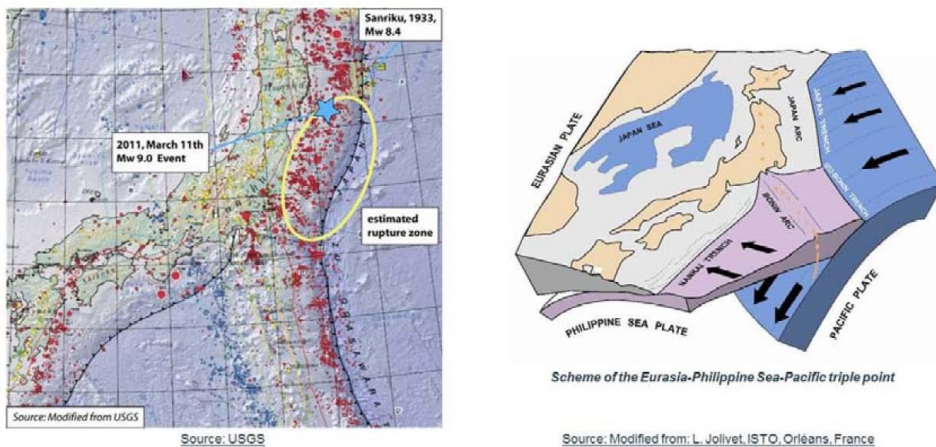


**Fig. 1.** The wave form recorded at Kiev IRIS station (Kiev, Ukraine) of 11.03.2011 earthquake in Japan with  $M_w = 9.0$ ,  $\Delta = 73.84^\circ$ ,  $h = 21.9$  km,  $\varphi = 38.29^\circ N$  and  $\lambda = 142.49^\circ E$ .





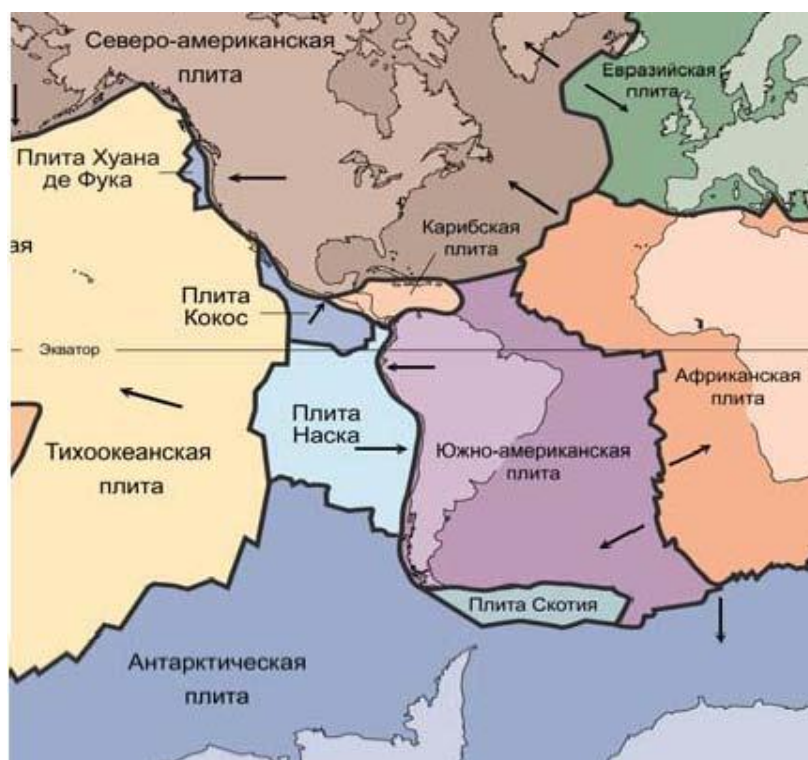
**Fig. 2. a) predicted maximum intensity seismic hazard map near east coast Honshu in Japan, b) the observed intensity data map for earthquake that occurred at 05:46:23 UTC 11/03/2011 [1]**



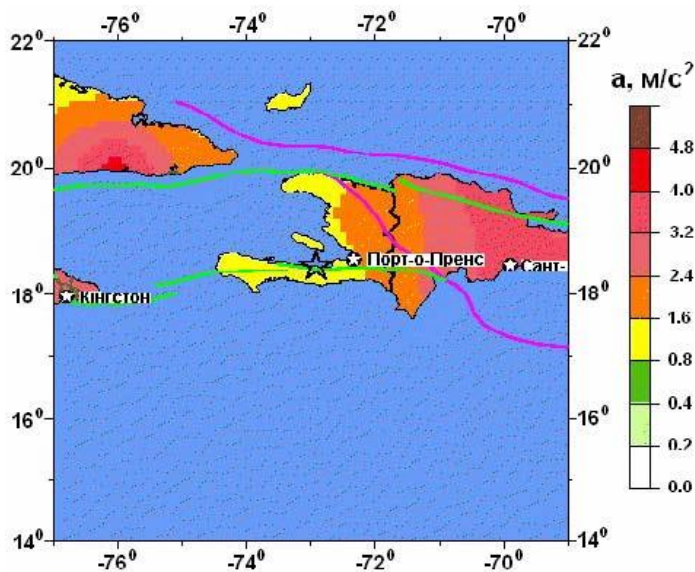
**Fig. 3. The seismic map of estimated rupture zone of the thin Pacific Plate collision with the Eurasian Plate and the origin of 11.03.2011 earthquake. In the right side of figure the scheme of the Eurasia-Philippine-Sea-Pacific triple point is shown [2, 3]**

Earthquake in Haiti, as seen in Fig. 4 [4], occurred within a seismically active zone associated with the zone of collision of the Caribbean plate with the South America plate. The earthquake near Chile is with the feat of the Nazca plate under the South American continental plate. In both cases, the earthquake occurred in areas where strong seismic events are not uncommon, which made seismologists and leadership of both countries in

advance to shape up for strong earthquakes. Evidently, as seen from a comparison of maps of general seismic zoning (GSZ) of the territory of Haiti, presented in Fig. 5 [6], and maps of macroseismic manifestations of the 01/12/2010 earthquake, as presented in Fig. 6 [7], the intensity of seismic manifestations of the earthquake was, in fact, higher than predicted by seismologists to map of the Haiti GSZ. The level of projected acceleration of seismic vibrations The level of projectd acceleration of seismic vibrations on the map, which, with probability 90% will not be exceeded over the next 50 years, corresponds to the average acceleration of seismic vibrations in the 7-balls earthquake. In fact, during the 12/01/2010 earthquake, as seen in Fig. 6, in the Port-au-Prince capital city of Haiti were observed 9 balls macroseismic effects (on 12 point scale). Clearly, projected onto the 7-ball impact homes and buildings could not remain 9-balls intact.



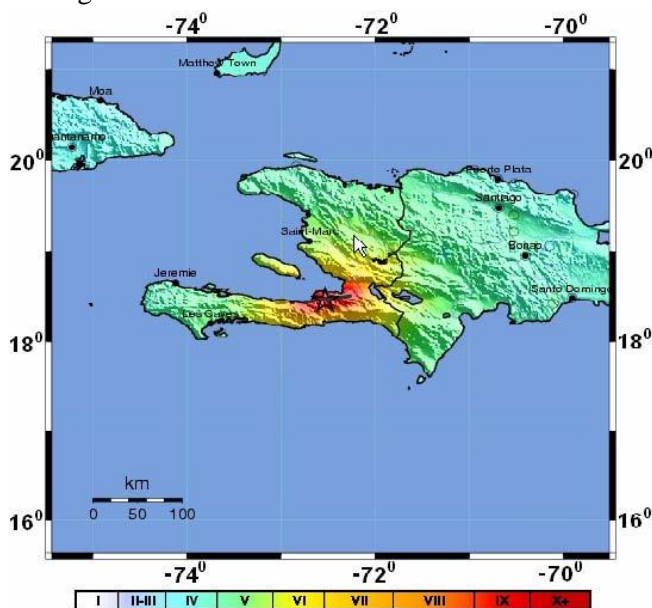
**Fig. 4. Lithosphere plates in the western hemisphere of the Earth (clipping from maps of [5])**



**Fig. 5. General seismic zoning map of the Haiti island and the neighboring areas [6]. Color denotes the projected value of acceleration of seismic vibrations in  $m/s^2$ , which is likely 90% will not be exceeded over the next 50 years, which corresponds to the average period of occurrence of the maximum earthquake every 500 years**

As a result, the main shock and several hundreds of aftershocks have killed more than 280 thousand people, several million people lost their homes and jobs. According to the Inter-American Development Bank's the losses caused by the earthquake could reach 14 billion dollars [8]. In addition, the experience of similar past disasters is well known that after their income level of the population is reduced on average by 30%, despite the assistance provided by the international community. The earthquake near the coast of Chile, was much more powerful, but according to official information, the number of its victims was much lower (780 people), primarily because the country for many years considerable attention devote for earthquake-protection design and construction, as well as for the protection from tsunamis. Especially intensive, this work is carried out after the 22/05/1960 quake with  $M_w = 9.5$ , which is considered as the strongest since 1900, when the registration of seismic events in the world have been widely used the instrumental techniques. Comparison of the earthquakes effects in Haiti and Venezuela shows the importance of properly assessing the level of Seismic risk of the sites of existing and planned buildings and structures. Adopted at this time in the world the concept of seismic protection includes the need for protection from

earthquakes by each investor, owner and developer who are building houses and industrial buildings in seismic zones.



**Fig. 6. Map of 01/12/2010 earthquake with  $M_w = 7.0$  macroseismic manifestations on the Haiti island [7]. Color denotes the intensity of the recorded seismic tremors in the points of modified Mercalli scale.**

At the same time, it should be noted that self-investors, owners and developers are unable to obtain the seismological information about the magnitude of the parameters of the maximum seismic effects, which with a given probability of exceeding can be realized at the site of the existing or projected development, and is needed for its seismic protection. This task must be decided by the State. In particular, the Ministry of Regional Policy and the building of Ukrainian together with the National Academy of Sciences have developed and introduced into operation at 2007, State Building Codes B.1.1:12-2006 “Building in seismic regions of Ukraine” [9], where in Appendix A, the table of communities with specification of seismic shaking projected intensity, and in Appendix B – the general seismic zoning maps, which shows the predicted intensity of seismic shaking on a MSK-64 macroseismic scale, which is 90, 95 and 99 percent will not be exceeded over the next 50 years. In the main text of this document provides rules for the use of seismic data as well as rules for the protection of structures and buildings in the different seismic conditions [9].

The territory of Ukraine to the south and south-west is comprehended by the influence of powerful seismically active zone of the planet, which resulted from the

collision of large tectonic plates: Eurasian, African, Arabian and Indian. The belt stretches from the Azores through the Mediterranean and Black Sea, Caucasus, Central Asia and further to the Hindu Kush, Tibet - the island of Sumatra, and further south, where it connects with the Pacific planetary seismically active zone. Influence from this zone extends to the western regions of Ukraine, Bukovina, and south-western part of the Odessa region, south of Mykolaiv, Kherson, Zaporozhye regions and the territory of Crimea. The belt includes the Carpathian arc with strong subcrustal earthquakes in the Vrancea area, which in the past 5 times shaken not only the territory of Ukraine, but even Moscow and St. Petersburg. Earthquakes in the territory of Ukraine were in the past, recorded by seismic stations and are felt by the people at present and, unfortunately, will be in the future. Seismic risk in Ukraine is high also because of insufficient knowledge of local seismicity and the understatement of the real seismic hazard assessment regulatory by document SNIP-II-7-81 "Building in seismic areas" [8], which operated in Ukraine until 2007. Determination of the real parameters of seismic hazard requires instrumental seismological observations of the local seismic activity and of the powerful remote seismic events. In the conditions of increasing anthropogenic loads and a significant depreciation of fixed assets in Ukraine the risks associated with the hazardous effects of earthquakes significantly increased, which, in turn, increases the level of technological risk in different sectors of the economy. Accompanied by faults, landslides, mudflows, tsunamis and other hazards, earthquakes can cause considerable material and social consequences. In recent years, with a sufficiently short time intervals, there were a catastrophic earthquake (12.05.2008 in China with  $M_w = 7.8$ ; 05.10.2008 in Kyrgyzstan with  $M_w = 6.6$ ; 06.04.2009 in Italy with  $M_w = 6.3$ ; 13/01/2010 at the Haitian with  $M_w = 7.0$ ; 26.02.2010 in Japan with  $M_w = 7.2$ , 27/02/2010 in Chile with  $M_w = 8.8$ ; 04.03.2010 in Taiwan with  $M_w = 6.4$ ; 11.03.2011 in Japan, with  $M_w = 9.0$  etc.), which led to deaths and huge financial losses. In most cases, the destruction of structures and buildings is due to underestimation of the real seismic hazard of areas. Losses from earthquakes can be substantially reduced with appropriate technical and organizational preparations for them. Properly determining the level of seismic hazard and its inclusion could to avoid casualties and material losses minimized. In preparation for future earthquakes in the Ukraine it is current studies of the seismic resistance of existing buildings and structures in areas where the real seismic hazard on the new seismic GSM-2004 maps proved to be higher than specified on the regulatory CP-78 map [9] current up to 2007. The input data should serve on observations of local and teleseismic earthquakes at seismic stations located in studied areas, or as close as possible to them.

The world's modern science-based concept of effective seismic protection include: the identification of quantitative parameters of real seismic hazard and risk reducing, the

vulnerability of populated areas by improving the seismic resistance of existing buildings and structures, development and implementation of earthquake-resistant construction norms that meet the real seismic hazards, monitoring of seismic design and regular maintenance of buildings and facilities, raising awareness by education and training, early warning of the emergence of a strong earthquake and rapid response, rehabilitation victim populations and areas; insurance against the effects of earthquakes. Experience in the field of seismic protection of such developed countries as Japan, USA, Canada, France, Italy and others, shows that the basis of seismic protection in Ukraine should be the introduction of earthquake-resistant design and construction of housing and industrial facilities on the basis of objective knowledge about the quantitative parameters of real seismic hazard in their areas of deployment and on concrete construction sites.

Knowledge of the real seismic hazard, along with reliable data on the seismic vulnerability of structures is necessary for earthquake resistant design and develops measures to reduce the seismic risk. The main link, which provides objective data for activities of protection against earthquakes, is seismic observations. Institute of Geophysics of NAS provides activity of a seismic stations network, which actually performs the role of the national seismological network for providing information for all seismic protection works. The network provides standardized data on seismic manifestations on the territory of Ukraine. On these data the evidence-based forecasts of seismic hazard values are determined. It is necessary for central and local authorities to ensure the stable development of the seismic regions, as well as for the research institutes of other ministries and agencies working in related industries of earthquake-resistant design and construction. According to the Cabinet of Ministry of Ukraine ruling from 28.06.1997, № 699 in the IGPh of NAS of Ukraine the National Center for Seismic Data and the two regional centers: Carpathians (Lviv) and Crimea (Simferopol), which continuously receives the data of instrumental observations from the seismic network and geophysical stations of Ukraine - are operate. At present, the observation network consists of 37 seismic and geophysical stations, including reference seismic station "Lviv", "Uzhgorod", "Mizhhirria", "Kosiv", "Kiev-IRIS», "Simferopol", "Yalta", "Sevastopol", "Rahov", "Kamianets' Podolsky, magnetic observatory Dymmer", "Odessa", "Ivano-Frankove" and several regional stations. In 2009, opened two new seismic station: "Nicholaev" and "Shutskoe. "Results of seismic observations are widely used in solving problems in key directions of fundamental research of IGPh of NAS: the study of the tectonics, structure, geodynamics, and evolution of continental and oceanic lithosphere; construction three-dimensional integrated geophysical and petrophysical models of geological structures in order to predict mineral development and introduction of new technological systems for processing and interpreting geophysical data; geophysical

studies of the environment in order to predict seismic hazards and other threats to natural phenomena.

Geodynamic processes that are constantly changing stress-strain state of geological environment, not only in seismically active zones, but as it is now scientifically proven, in the territories of ancient platforms of planet, requires permanent monitoring tools. The integration of seismic and other geophysical studies can learn communication geophysical fields with the preparation of strong earthquakes sources.

### **Conclusion**

Earthquake-resistant design and development of anti-seismic measures require knowledge of the quantitative parameters of the real seismic hazard and seismic data on the vulnerability of structures. The main link supplying objective data for activities to protect against earthquakes are seismological observation.

To obtain reliable baseline data is necessary to ensure the further expansion (increase in the number and uniformity of the distribution) network of seismic stations and its re-equipment by modern equipment and software. At the state level is necessary to provide a centralized ordering and funding for the regular (once per 10 years) updating maps of general seismic zoning of the territory of Ukraine and for the improvement of regulations on earthquake-resistant design and construction, taking into account new data on the geodynamic situation in the country's territory and using new improved methods of quantification of real seismic hazard on the construction and maintenance sites.

### **References**

1. `David Cyranoski. Japan faces up to failure of its earthquake preparations. Systems for forecasting, early warning and tsunami protection all fell short on 11 March. - Source: Kyoto University & Japan Met. Agency, Tokyo: Nature, Vol 471, 31/03/2011. - 557 p.
2. Mw 9.0 off the Pacific coast of Tohoku, Japan Earthquake, on March 11th, 2011 at 05:46 UTC//Centre Sismologique Euro-Méditerranéen. - <http://www.emsc-csem.org/Page/index.php?id=196>
3. <http://www.emsc-csem.org/Earthquake/alert/index.php?id=av576;INFO&date=2011-03-11>
4. [http://upload.wikimedia.org/wikipedia/ru/2/22/Tectonic\\_plates\(rus\).png](http://upload.wikimedia.org/wikipedia/ru/2/22/Tectonic_plates(rus).png)

5. [http://neic.usgs.gov/neis/eq\\_depot/2010/eq\\_100112\\_rja6/neic\\_rja6\\_w.html](http://neic.usgs.gov/neis/eq_depot/2010/eq_100112_rja6/neic_rja6_w.html)
6. <http://earthquake.usgs.gov/eqcenter/shakemap/global/shake/2010rja6/>
7. [http://www.rbc.ua/rus/newslineshow/mezhamerikanskiy\\_bank\\_razvitiya\\_ushe\\_herb\\_prichinennyi\\_zemletryaseniyem\\_gaiti\\_mozhet\\_dostigat\\_14\\_mlrd\\_doll\\_16\\_022010](http://www.rbc.ua/rus/newslineshow/mezhamerikanskiy_bank_razvitiya_ushe_herb_prichinennyi_zemletryaseniyem_gaiti_mozhet_dostigat_14_mlrd_doll_16_022010)
8. State building codes SBC B.1.1-12: 2006 "Building in seismic regions of Ukraine. - Kiev: Ministry of Construction, Architecture and Housing and Communal Services of Ukraine, 2006.–84p. (In rus).
9. Seismic zoning of the USSR. (Methodological framework and regional description of the 1978 map) // Editor. V.I. Bune and G.P. Gorshkov - M.: Nauka, 1980. - 308 p. (In rus).

## **ASSESSMENT OF THE SEISMIC SITE EFFECTS BASED ON EARTHQUAKE RECORDINGS AND IN SITU BOREHOLE MEASUREMENTS IN BUCHAREST, ROMANIA**

**Andrei Bala<sup>1</sup>, Alexandru Aldea<sup>2</sup>, Stefan Florin Balan<sup>1</sup>, Cristian Arion<sup>2</sup>**

<sup>1</sup> *National Institute for Earth Physics, Bucharest-Magurele, Romania*

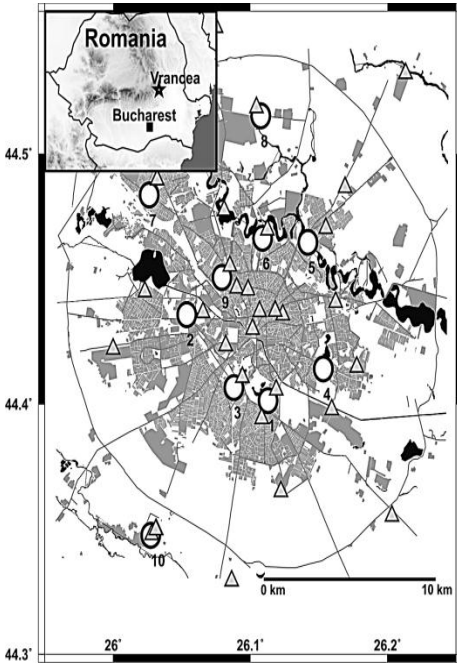
<sup>2</sup> *Technical University for Civil Engineering (UTCB), Bucharest, Romania*

<sup>1</sup>*bala@infp.ro*

### **1. Seismic Measurements Performed In The Frame Of The Nato Sfp Project 981882**

The latest results in the shear wave velocity measurements were obtained in the frame of the NATO SFP Project 981882 in the years 2006-2007 and they were reported by [4] and [5], see Table 1. The mean seismic velocities computed for the 10 particular sites in Table 1 are representative values for the 6 types of Quaternary sedimentary layers in Bucharest City, the 10 sites being spread mainly in the city centre (see Fig. 1). The mean seismic velocities in the Table 1 can be correlated with averaged  $V_s$  values obtained by direct measurements and cited by other sources.





**Fig. 1. Map with area under investigation.**

The metropolitan region of Bucharest, Romania, is mainly inside the characteristic ring road with a diameter of about 20 km. Residential and industrial areas are indicated in grey; lakes, channels and rivers in black. The ten borehole sites are shown as circles and numbers which correspond with those from Table 1.

Sites with broadband instruments during the URS experiment [6] (Ritter et al. 2005) are indicated with triangles.

Mean weighted values for  $V_p$  and  $V_s$  are computed for each site (borehole) according to the following formula:

$$\bar{V}_S = \frac{\sum_{i=1}^n h_i}{\sum_{i=1}^n \frac{h_i}{V_{Si}}} \quad (1)$$

In equation (1)  $h_i$  and  $V_{Si}$  denote the thickness (in meters) and the shear-wave velocity (in m/s) of the  $i$ -th layer, in a total of  $n$  layers, found in the same type of stratum [2] and [7]. According to the same code, the weighted mean values  $\bar{V}_S$ , computed for at least 30 m depth, determine 4 classes of the soil conditions:

1. Class A, rock type:  $\bar{V}_S \geq 760$  m/s;
2. Class B, hard soil:  $360 < \bar{V}_S < 760$  m/s;
3. Class C, intermediate soil:  $180 < \bar{V}_S < 360$  m/s;

4. Class D, soft soil:  $\bar{V}_s \leq 180$  m/s;

All the  $V_{s,30}$  values in Table 1 belong to type C of soil after this classification, after [2] and [7].

### **10 boreholes in Bucharest City. A description of the geologic layers is found in [8] and [9]**

The mean weighted seismic velocities for the first 6 (of 7 types) of Quaternary layers were computed for all the 10 sites, in order to be compared with seismic velocity values obtained from previous seismic measurements and to be used as input for modelling with the widely applied program SHAKE 2000. Using SHAKE 2000 we compute spectral acceleration response and transfer functions for every site in which *in situ* measurements were performed. The acceleration response spectra correspond to the shear-wave amplifications due to the models of sedimentary layers down to: a). 50 m depth; b). 70 m depth; c). 100 m depth.

### **2. Spectral Acceleration Computed For 50 M Depth Models**

Different methods of ground response analysis have been developed including one dimensional, two dimensional, and three dimensional approaches. Various modelling techniques like the finite element method were implemented for linear and non-linear analysis. Extended information on these analyses is given in [10] Here we apply an equivalent linear one-dimensional analysis, as implemented in the computer program SHAKE2000 [3]. The *static soil properties* required in the 1D ground response analysis with SHAKE2000 are: maximum shear wave velocity or maximum shear strength and unit weight. Since the analysis accounts for the non-linear behaviour of the soils using an iterative procedure, *dynamic soil properties* play an important role. The shear modulus reduction curves and damping curves are usually obtained from laboratory test data (cyclical triaxial soil tests). The variation in geotechnical properties of the individual soil layers should be assumed constant for each defined soil layer. In-built shear modulus reduction curves and damping curves for specific types of layers are used in SHAKE2000 based on published geotechnical tests [3].

Table 1

**Mean weighted seismic velocities for the first 6 (of 7 types) of Quaternary layers in 10 boreholes in Bucharest City. A description of the geologic layers is found in [8] and [9]**

Geologic stratum type	1		2		3		4		5		6		$V_{S0}^{S3}$	
	Mean weighted seismic velocities [m/s]													
	$V_p$	$V_s$	$V_p$	$V_s$	$V_p$	$V_s$	$V_p$	$V_s$	$V_p$	$V_s$	$V_p$	$V_s$		
1.Tineret Park TINP	180	140	570	220	856	299	---	--	1666	398	---	---	263	
2.Ecology Univ. EUNI	300	120	1180	220	1250	241	1610	354	1850	390	2042	401	286	
3.Astronomy Inst. INAS	200	120	914	260	1200	330	1440	350	1900	390	2124	433	283	
4.Titan2 Park TITAP	290	160	800	250	800	250	980	350	1576	381	1850	450	299	
5.Motodrom Park MOTO	650	200	650	200	1320	320	1827	393	1980	410	2050	410	288	
6.Student Park STUP	490	210	490	210	1361	342	1570	370	1607	375	1820	400	295	
7.Bazilescu Park BAZI	500	160	500	160	1484	317	1850	390	2103	408	---	---	294	
8.Romanian ShootingFed. FRTIR	670	210	1440	330	1440	350	1718	400	1900	400	---	---	327	
9.Geologic Museum GEOM	340	180	1250	310	1511	322	1935	376	1950	380	---	---	320	
10. NIEP site NIEP	370	250	1710	350	1710	350	1810	320	1739	337	2090	410	326	
All sites.	325	169	854	252	1243	320	1530	367	1832	386	2005	417		

As input data the interval seismic velocities  $V_s$  (in m/s) as well as the natural unit weight (in  $kN/m^3$ ) and thickness of each layer (in m) were used. The recorded motion of the 27.10.2004 earthquake ( $M_w=6$ ) at K2 accelerometer station PRI in Bucharest was used as seismic input motion. All 3 components (one vertical and two horizontal components) were available. This accelerometer station is placed in the borehole near the City Hall site at 52 m depth. The strong motion PRI\_EW (east-west component) was used for modelling as it was the highest signal from the two horizontal components. The strong motion was applied at the base of all geologic models constructed down to 50 m depth as "inside" motion. The results of the linear modeling with SHAKE 2000 program for the 10 boreholes are presented in the Fig. 2 as graphs of spectral acceleration. In Fig. 2 the maximum values of the spectral accelerations occur around the 3 main the periods:  $T_1 = 0.13$  s;  $T_2 = 0.2$  s;  $T_3 = 0.55$  s. The highest

values occurred at the period  $T_2 = 0.2$  s, and they are between 0.22 g and 0.48 g. If we consider a comparison of the values at surface, they are between 0.22 g at Romanian Shooting Fed. (northern part of Bucharest) and 0.48 g (Ecologic Univ. in the central part of Bucharest), as it is shown in [1] and [11]. The values of acceleration at surface are presented in the Fig. 3 and they are between 0.055 – 0.080 g for the first 7 out of the 10 boreholes. For the last 3 sites values as large as 0.08 – 0.095 g resulted from modeling (Ecologic Univ.; Titan 2 Park; Bazilescu Park). These high values are greatly influenced by the thickness of the Quaternary layers 1 and 2 from the surface and also by the physical and dynamic characteristics of all layers, [1] and [11].

### **3. Spectral Acceleration Graphs Computed For 70 M Depth Models**

In the second stage the recorded motion of the 27.10.2004 earthquake ( $M_w = 6$ ) at accelerometer station UTCB1 in Bucharest was used as seismic input motion. All 3 components (one vertical and two horizontal components) were available. This accelerometer station is placed in the borehole UTCB Tei site at 78 m depth.

The strong motion TEI\_EW (east-west component) was used for modelling as it was the highest signal from the two horizontal components. The strong motion was applied at the base of the geologic models constructed down to 70 m depth as "inside" motion. Spectral acceleration graphs for the 10 chosen models down to 70 m depth are presented in Fig. 4, as well as the spectral acceleration of the strong motion applied in the lower part of the figure. The spectral acceleration peaks values varies from 0.15-0.25 g at Student Park, Geologic Museum and F.R.Tir to 0.3 g at NIEP-Magurele in the south. Maximum values of 0.4 g are present at Ecologic Univ. and Titan2 Park, lower than the values obtained in the Fig. 2 for the 50 m geologic models. The variation of peak acceleration in the depth is presented in the Fig. 5 for the 10 sites and they are between 0.023 g (at 70 m depth) and it can reach 0.045 - 0.08 g at surface, lower than the maximum values presented in the Fig. 3 for the 50 m geologic models.

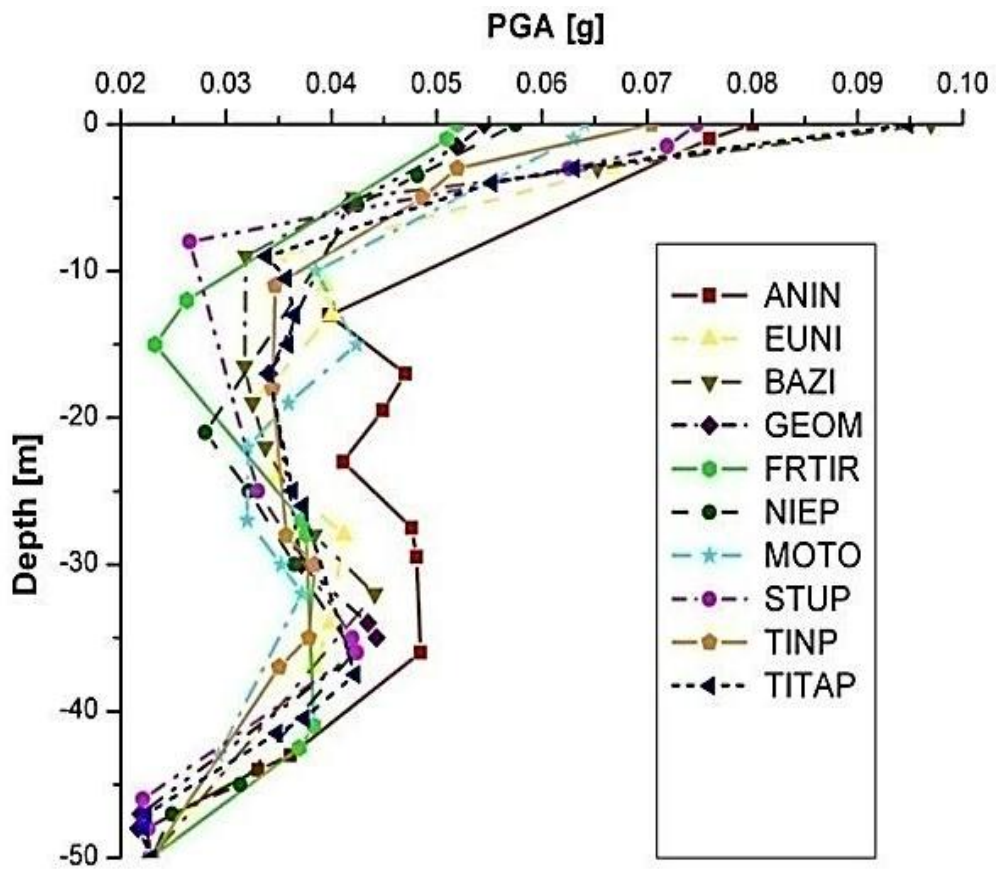


Fig. 3. PGA variation with depth as result from equivalent-linear modelling in the 10 boreholes in Bucharest, down to 50 m depth

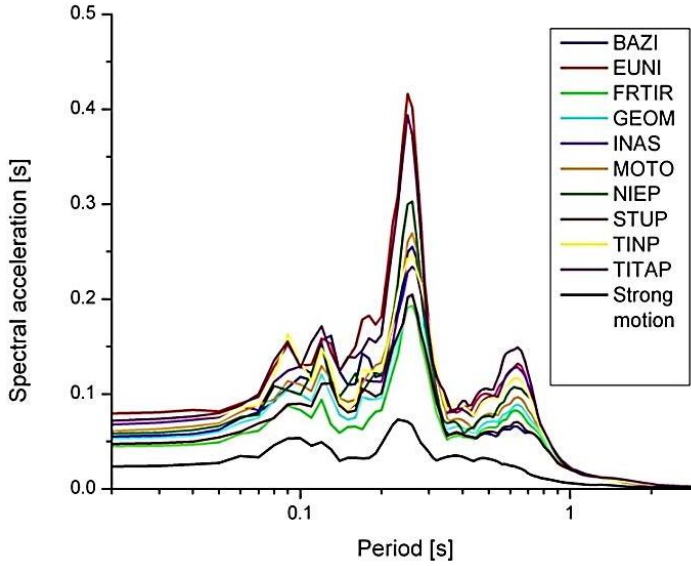


Fig. 4. Spectral acceleration response computed with the input strong motion TEI\_EW for the 10 sites in Bucharest, down to 70 m depth

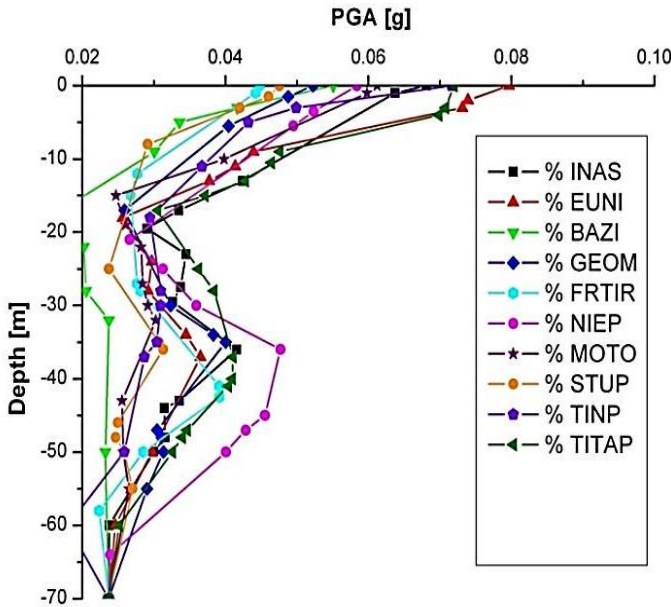


Fig. 5. PGA variation with depth as result from equivalent-linear modelling in the 10 sites in Bucharest, down to 70 m depth

#### **4. Calibration Of The 70 M Model With A Real Signal Recorded At Surface**

In Fig. 6 the spectral acceleration of the original strong motion recorded at 78 m (curve 2) and the resulting spectral acceleration obtained by modelling at surface (curve 1) are presented. The spectral acceleration of the strong motion recorded at surface in the same site (curve 3) is compared with the spectral acceleration obtained by modelling (curve 1) and a very good match is obtained, although the second has lower values especially around the first peak at 0.1 s.

##### **1. Spectral Acceleration Computed For 100 M Depth Models**

In the third stage the recorded motion of the 27.10.2004 earthquake ( $M_w=6$ ) at accelerometer station INCERC in Bucharest was used as seismic input motion (BBI\_EW, EW component. This accelerometer station is placed in the borehole at INCERC site at 140 m depth.

The strong motion BBI\_EW (east-west component) was used for modelling as it was the deepest recorded signal in a borehole. The strong motion was applied at the base of the geologic models constructed down to 100 m depth as "inside" motion. Spectral acceleration graphs for the 7 chosen models down to 100 m depth are presented in Fig. 7, as well as the spectral acceleration of the strong motion applied in the lower part of the figure.

The spectral acceleration peaks values varies from 0.060 - 0.100 g at Bazilescu Park and Geologic Museum. Maximum values of 0.110 g are lower than the values obtained in the Fig. 4 for the 70 m geologic models. The spectral acceleration graphs in Fig. 9 have 2 peaks: one at 0.15 s and the second at 0.3 s, at the same periods as the spectral acceleration of the original strong motion (red curve). The absolute value reaches 0.095 g at 0.15 s, which means an amplifications of 3 times of the original signal through the shallow sedimentary layers.

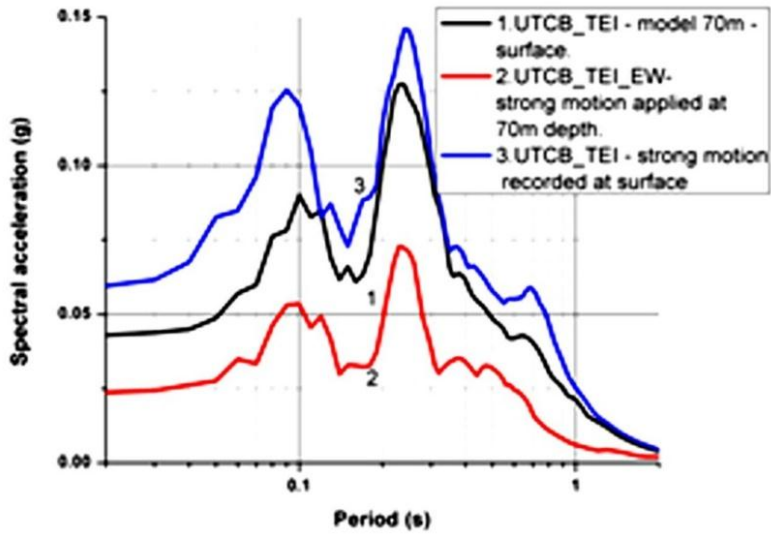


Fig. 6. UTCB(TEI\_EW) Spectral acceleration calibration of the model 0 - 70 m (curve 1) with the signal recorded at surface (curve 3) in the same place

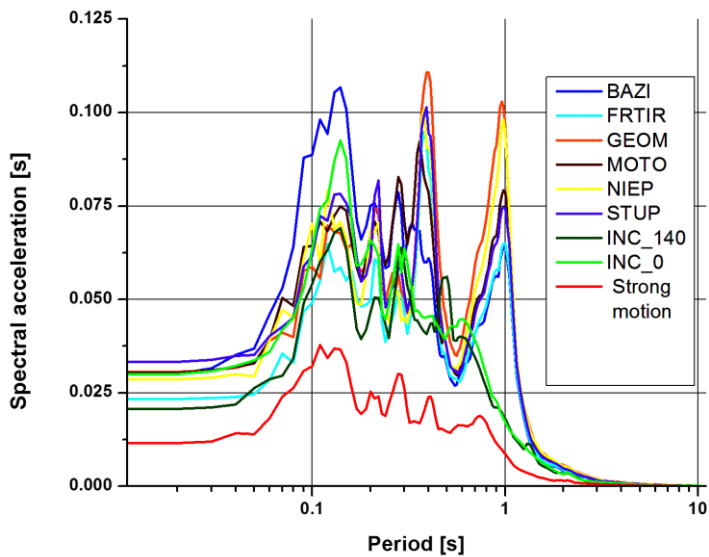


Fig. 7. Spectral acceleration response computed with the input strong motion INC\_EW for the 7 sites in Bucharest, down to 100 m depth.



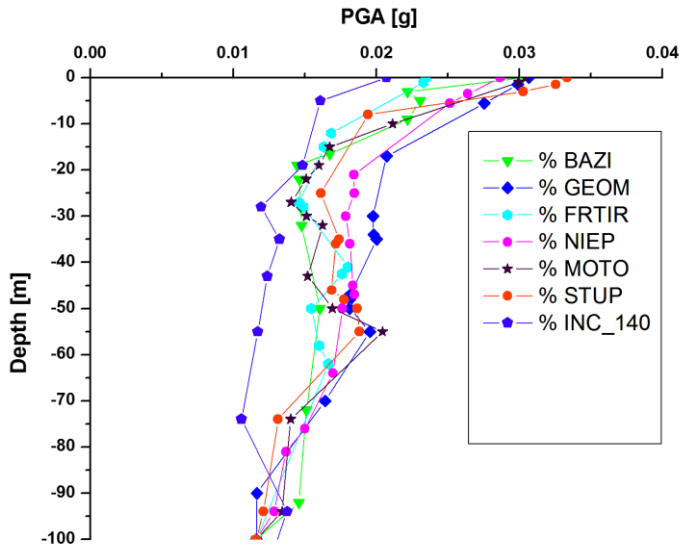


Fig. 8. PGA variation with depth as result from equivalent-linear modelling in the 7 sites in Bucharest, down to 100 m depth.

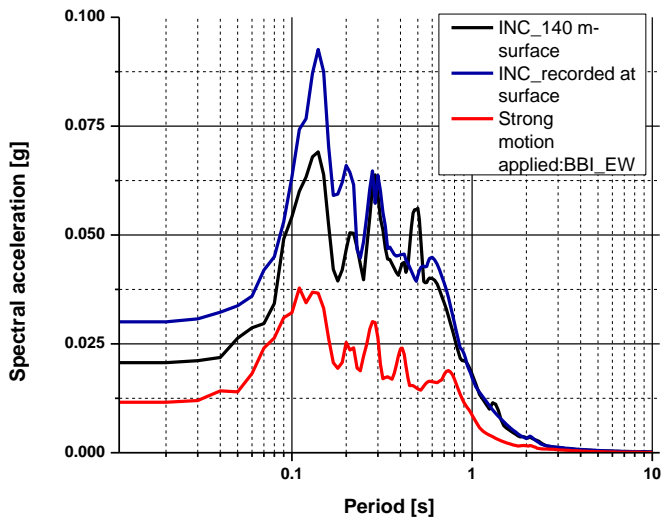


Fig. 9. Spectral acceleration calibration of the model 0 - 100 m, INCREST\_TEI-140 m, with the signal recorded at surface in the same place; red curve - strong motion applied to the model; black curve - spectral acceleration model at surface; blue curve - spectral acceleration recorded at surface.

In Fig. 9 the spectral acceleration of the original strong motion recorded at 140 m (red curve) and the resulting spectral acceleration obtained by modelling at surface (black curve) are presented. The spectral acceleration of the strong motion recorded at surface in the same site (blue curve) is compared with the spectral acceleration obtained by modelling (black curve) and a good match is obtained, although the second has lower values especially around the first peak at 0.15 s.

### **Conclusions**

1. The spectral acceleration graphs in Figs. 2, 4 and 7 demonstrates that the computed models have the peaks at the same periods as the spectral acceleration of the original strong motion applied at the base of the model. The absolute values of the peaks show an amplification of about 3 times of the original signal through the shallow sedimentary layers in the geological model.
2. The acceleration graphs in the depth in Figs. 3, 5 and 8 show some variations between the depth of the models and 20-25 m. After that a sharp increase of the acceleration occurs from this level to the surface.
3. A strong peak which appeared at higher periods, between 0.5-0.6 s (Fig. 2) and 1 s (Fig. 7) is considered as an artifact of the computer program. It represents the dominant period for a package of sedimentary layers with a depth of the model adopted. However due to the fact that the depth of the model does not coincide with the engineering bedrock in our examples, the real motion recorded at surface does not show this peak (Figs. 6 and 9). This demonstrates that this peak is an artifact and should not be considered for further analysis.
4. The fact that the characteristic period around of 1-1.15 s, corresponding to a depth of the engineering bedrock around 100 m, is not present on the original recorded motion at surface in the Fig. 9 shows that this bedrock is not present here and it is probably much deeper. Other geological observations placed the bedrock at 500-1000 m depth in the Bucharest area, coinciding with the upper interface of the Cretaceous limestones [12].

### **Acknowledgements**

This work was supported by CNCSIS - UEFISCDI, project number IDEI ID\_78/2008, conducted by National Institute for Earth Physics, Bucharest, Romania: **Seismic local site effect studies by interdisciplinary modeling employing equivalent-linear and non linear methods.**

### **References**

1. NATO Science for Peace project 981882 - Site-effect Analyses for the Earthquake-endangered metropolis Bucharest, Romania, Final report 2009, Ed. Univ. "Alexandru Ioan Cuza", Iasi, 2009.

2. Romanian Code for the seismic design for buildings - P100-1, 2006.
3. Ordóñez G.A., SHAKE2000: A computer program for the 1-D analysis of geotechnical earthquake engineering problem, 2003.
4. Bala A., Ritter J.R.R., Hannich D., Balan S.F., Arion C., Local site effects based on in situ measurements in Bucharest City, Romania, Proceedings of the International symposium on Seismic Risk Reduction, ISSRR-2007, Bucharest, pp. 367-374, 2007.
5. Bala, A., Balan, S.F., Ritter, J.R.R., Rohn, J., Huber G., Hannich, D., Site-effect analyses for the earthquake-endangered metropolis Bucharest, Romania, 127 p, Ed. Univ. "Alexandru Ioan Cuza", Iasi, 2010.
6. Ritter J.R.R., Balan, S., Bonjer, K.-P., Diehl, T., Forbriger, T., Marmureanu, G., Wenzel F. and Wirth, W., Broadband urban seismology in the Bucharest metropolitan area, Seism. Res. Lett., 76, pp 573-579, 2005.
7. EUROCODE-8 - prEN1998-1-3 - Design provisions for earthquake resistance of structures, European Committee for Standardisation, 2001.
8. Ciugudean-Toma, V., Stefanescu, I., Engineering geology of the Bucharest city area, Romania, IAEG -2006, Engineering Geology for Tomorrow's Cities, paper no. 235, 2006.
9. Bala A., Zihan I., Ciugudean V., Raileanu V., Grecu B., Physical and dynamic properties of the Quaternary sedimentary layers in and around Bucharest City, Proceedings of the International symposium on Seismic Risk Reduction, ISSRR-2007, Bucharest, pp 359-366, 2007.
10. Kramer, S.L., Geotechnical Earthquake Engineering, Prentice Hall, Upper Saddle River, New Jersey, 1996.
11. Bala, A., S.F. Balan, J.R.R. Ritter, D. Hannich, Modeling of seismic site amplification based on in situ borehole measurements in Bucharest, Romania, <http://www.ecgs.lu/jlg95-abstracts/>, 2009.
12. Bălă Andrei, Geologic and geophysical models with application in assessment of the local site effects in Bucarest, Romania, Ed. GRANADA, 176 p, in Romanian, ISBN 978-973-8905-88-7, 2010.

## **RISING EARTHQUAKES: PRECURSOR OF VOLCANIC WINTERS/ICE AGE THAT WE MAY AVERT - OTHER NECESSARY PREPARATIONS**

**Goulopoulos Nikolaos**

*Afforestation Allianc, Greece,  
irinipeace1@yahoo.gr*

**Risingearthquakes:** precursor of volcanic winters/ice age that we may  
AVERT - Other necessary preparations.

Several studies since the '70ies show a correlation between weak solar cycles and raised magma and volcanic activity. Present data show not only a weak solar cycle and a rise in earthquakes - volcanic eruptions – cloudiness - storms, but that most probably next decades will be worse. (The proposed explanation is that planet positions disperse electricity from the galactic centre to the planets from its course to the sun, so Earth's

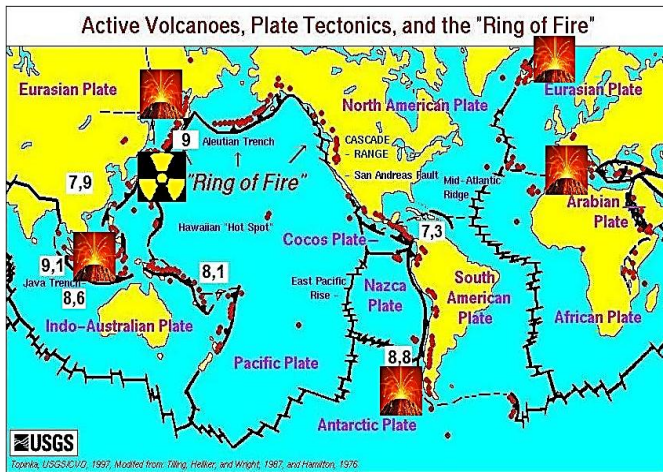
magma is charged and is rising its disturbance). Volcanic winters occurring during solar minima, is a FREQUENT but not discussed enough phenomenon. Climate fluctuation has been remarked by Meton, and Archimedes constructed a computer such as that of Antikythera, to foresee the planets' orbits and influence on our climate. Last time similar to today's solar low activity, was the beginning of the 19<sup>th</sup> century, when the 1815-20 Tambora volcanic winter occurred..

First we propose a test with a fire-resistant cap or grid hold by zeppelins, some hundred meters above extra active volcanoes, in order to prevent volcanic ash to reach troposphere, and thus spread all over Earth with predictable catastrophic consequences, similar to those volcanic winters that provoked the collapse of Mayans, Aztecs and Incas with cannibalism. Secondly we propose an extended spread of soot over icecaps and other glaciers, in order to decrease albedo and melt them, as already, at least the 90% of Earth's ice in Antarctica raises. Last series of actions needed is decentralization of all present Babylons, to autarky villages and afforestation of ALL open places, even plains, to have food and wood in case of the worst scenarios. If research focus on galactic electricity, we may stop the dangerous magnetic poles shift!

**Keywords:** *volcanic winter, Antarctica, global cooling, ice age, Mayans, Aztecs, Incas, cannibalism, crater cap, autarky, afforestation.*

## **1. Solar Cycle Correlation With Magma And Volcanic Activity**

Several studies since the '70ies show a correlation between weak solar cycles and raised magma and volcanic activity [1]. Present data show not only a weak solar cycle and a rise in earthquakes - volcanic eruptions – cloudiness - storms, but that most probably next decades will be worse [2, 3], [Fig. 1, 2, 3] centre to the planets from its course to the sun, so Earth's magma is charged and is rising its disturbance including volcanism. [4] [Fig. 4, 5, 6]. As Heraclitus had noted that extraterrestrial 'thunderbolt steers the universe' ('τα πάντα οικιζει κεραυνός'), ancient greek Astronomer Meton had also attested that whenever sun had many sunspots, more rains occurred on Earth ('ηλίου σημεία μέλανα, ύδωρ'): we now know that a more active sun warms the Earth, and warmer oceans cause more long rains, instead of the storms we have during cooler periods.



Topographic USGS/CNO, 1997. Modified from Tilling, Heller, and Wright, 1997, and Hamilton, 1976  
 Ινδικός-2004, Σουμάτρα-2005, Τόνγκα-2006, Κίνα-2008, Ινδονησία-2009, Αϊτή / Χιλή-2010, Ιαπωνία-2011

Fig. 1. Last big earthquakes and raising volcanic activity

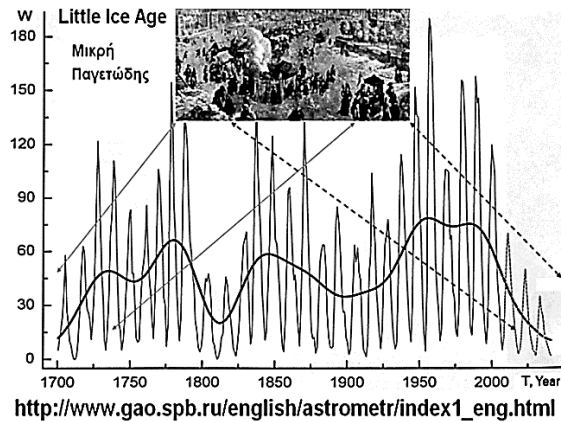


Fig. 2. Next solar cycles forecast by H. Abdusamatov.

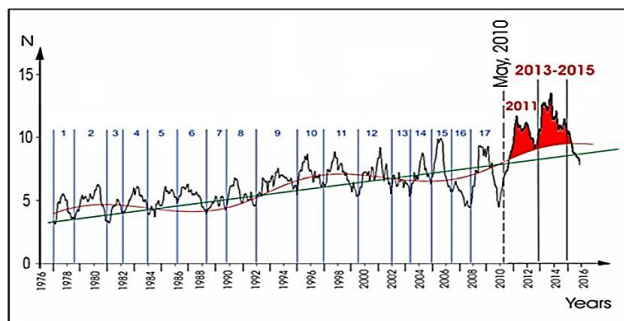


Fig. 3. Great natural disasters forecast by Khalilov E.N., 2010, Geochange-report.org

We propose as reason the present planet positions that disperse electricity from the galactic.

## 2. Volcanic Incidents

Volcanic winters is a FREQUENT [Fig. 6, 7] but not discussed enough phenomenon. Cold climate fluctuations probably had been remarked by Archimedes, who constructed a computer [5] such as that of Antikythera, to foresee the planets' orbits and influence on our climate [Fig. 8, 9].

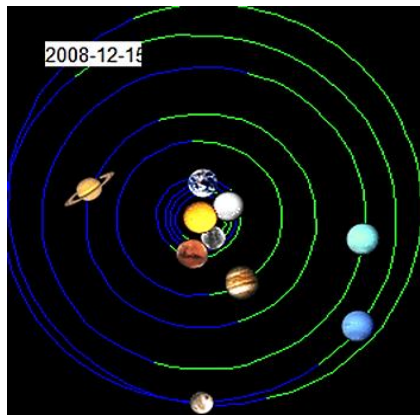
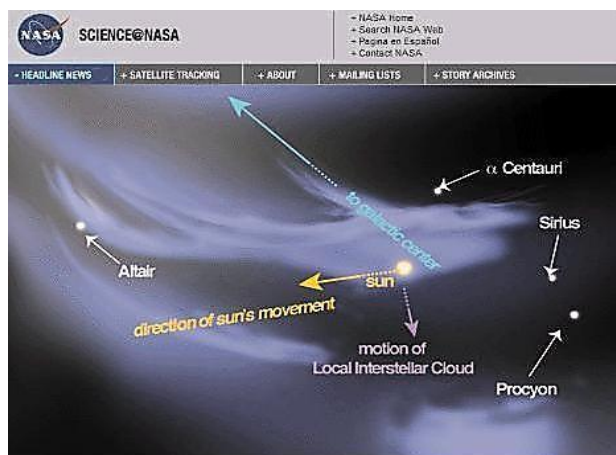


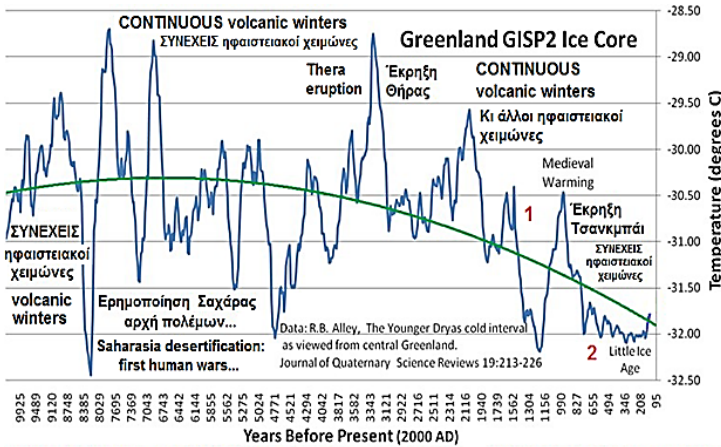
Fig. 4. Current planet positions, while the emitting galactic centre is to the south of the picture.



"more cosmic rays reach the inner solar system, affecting terrestrial climate": NASA, 23-12-2009  
[http://science.nasa.gov/headlines/y2009/23dec\\_voyager.htm](http://science.nasa.gov/headlines/y2009/23dec_voyager.htm)

Fig. 5. The galactic cloud where our solar system travels.

The inhabitants of ancient Thera 3.650 years ago, had already double or triple exits to their houses, in case of a blockage during quakes [Fig. 10]. They showed similar PROVIDENCE and were saved, leaving the island after the precursory big quakes, and escaping the huge volcanic eruption, that caused a worldwide devastating 5year volcanic winter [6]. While other peoples in the Middle East collapsed, Greek Thereans came back to their island and continued their magnificent contribution to the famous peaceable Aegean civilization!



SUGGESTIVELY: 1. Romans - Mayans COLLAPSE - 2. Aztecs - Incas COLLAPSE  
 ΕΝΔΕΙΚΤΙΚΑ: 1. ΚΑΤΑΠΠΕΥΣΗ Ρωμαίων, Μάγιας - 2. ΚΑΤΑΠΠΕΥΣΗ Αζτέκων, Ίνκας

Fig. 6. Continuous volcanic winters, temperature and civilization falls

1446 (n.d.)	1699 (n.d.)
1448 (possible eruptions in Alaska)	1742 (Shikotsu, 1739)
1453 (Kuwae, Vanuatu, SW Pacific)	1783 (n.d.)
1495 (n.d.)	1816 (Tambora, Lesser Sunda Isl.)
1587 (Kelut, Java, 1740. Shikotsu, Japan)	1817 (Tambora, 1815)
1601 (Huaynaputina, Peru)	1818 (Tambora, 1815)
1641 (Parker, Philippines)	1819 (Tambora, 1815)
1642 (Parker, Philippines)	1836 (Coseguina, Nicaragua)
1643 (Parker, Philippines, 1641),	1837 (Csiguina, Nicaragua, 1835)
1666 (possible eruptions in Japan),	1884 (Krakatoa, west of Java)
1667 (Shikotsu, same year)	1912 (Novarupta, Katmai Alaska same year)
1669 (Shikotsu, Japan, 1667)	1968 (n.d.)
1675 (Samkonora, Halmahera, 1673)	1978 (n.d.) , 1981 El Chicon
1698 (n.d.)	1992 (Pinatubo, Philippines)

Fig. 7. Some of the volcanic eruptions that kept Little Ice Age 600 years long.



**Fig. 8. Archimedes' murder**



**Fig. 9. Antikythera computer reconstruction**



**Fig. 10. Double exits in ancient Thera houses**



**Fig. 11. Pompeiian arena addiction...**

On the contrary, the arena addicted Pompeians 1700 years later, scorned fatalistically both the precursory quakes and the raising volcanic activity, and were



almost all burned... [Fig. 11] (The same thing happened during the 1902 Pelee eruption in Martinique...).

In the mean time some series of volcanic winters provoked the collapse of Mayans, Aztecs and Incas with cannibalism... [Fig. 12].

Last similar to the present solar condition time was the 1815-20 Tambora volcanic winter...

What must we expect now if a sudden volcanic winter occurs, when 7 billion people on Earth are both unsuspected and unprepared, most of them trapped in cement babylons???... Cannibalism and epidemics will be worse than the Little Ice Age (1300-1900) plagues, due to the aforementioned volcanic winters... There is also a possibility that Earth enters a new big Ice Age...



**Fig.12. Mayans-Aztecs Incas collapsed**

### **3. Proposals**

First we propose a test with a fire-resistant cap or grid hold by zeppelins [Fig. 13], some hundred meters above extra active volcanoes, in order to prevent volcanic ash to reach troposphere, and thus spread all over Earth with predictable catastrophic consequences. Secondly we propose an extented spread of soot over icecaps and other glaciers, in order to decrease albedo and melt them.

Last series of actions needed is decentralization of all present Babylons, to autarky villages and afforestation of ALL open places, even plains, to have food and wood in case of the worst scenarios. If research focus on galactic electricity, we may stop the dangerous magnetic poles shift!



**Fig.13. Fire resistant crater cap or grid instead of volcano NON Nuclear bombing.**



**Fig.14. Soot melts ice.**

## References

1. Abdurakhmanov A.I., *Firstov L.P., Shirokov V.A.* Possible connection of volcanic eruptions with 11-year cyclicity of solar activity. In the book *Bulletin of volcanic stations*. Moscow, Science, 1976, No.52, p.3-10.
2. [www.Geochange-report.org](http://www.Geochange-report.org)
3. Are Mega Earthquakes on the Rise? <http://www.livescience.com/13632-mega-earthquakes-increasing-japan-indonesia.html>
4. Toshikazu Ebisuzaki, Hiroko Miyahara, Ryuho Kataoka, Tatsuhiko Sato, Yasuhiro Ishimine. Explosive volcanic eruptions triggered by cosmic rays: Volcano as a bubble chamber
5. <http://www.sciencedirect.com/science/article/pii/S1342937X10001966>
6. Cicero: *De re publica* 1, XIV
7. [http://oll.libertyfund.org/?option=com\\_staticxt&staticfile=show.php%3Ftitle=546&chapter=83295&layout=html&Itemid=27](http://oll.libertyfund.org/?option=com_staticxt&staticfile=show.php%3Ftitle=546&chapter=83295&layout=html&Itemid=27)
8. Rutgers Newsletter: Volcanic explosion larger than Krakatoa triggers collapse of Bronze age; Dr. William Ryan of the Lamont-Doherty Earth Observatory of Columbia University
9. [http://geologymuseum.rutgers.edu/downloads/newsletter\\_-\\_2005\\_spring.pdf](http://geologymuseum.rutgers.edu/downloads/newsletter_-_2005_spring.pdf)
10. [http://2011.geocataclysm.org/index.php?option=com\\_content&view=article&id=20&Itemid=29](http://2011.geocataclysm.org/index.php?option=com_content&view=article&id=20&Itemid=29)

## MECHANICAL-MATHEMATICAL MODELING AND MONITORING FOR LANDSLIDES

**Svalova Valentina**

*Russia, [inter@geoenv.ru](mailto:inter@geoenv.ru)*

### Introduction

Landslides process is one of the most widespread and dangerous processes in the urbanized territories. In Moscow the landslips occupy about 3 % of the most valuable territory of city. In Russia many towns are located near rivers on high coastal sides. There are many churches and historical buildings on high costs of Volga River and Moscow River. The organization of monitoring is necessary for maintenance of normal functioning of city infrastructure in a coastal zone and duly realization of effective protective actions. Last years the landslide process activization took place in Moscow.

Landslide motions is extremely actual and difficult problem which decision is necessary for preservation of valuable historical monuments and modern city constructions. There are near 15 places of deep landslides and many shallow landslides in Moscow (Fig.1). One of landslide sites is on Vorob'yovy mountains, on a high slope of the right coast of the river Moscow. Within the limits of a considered site there is a historical monument of federal value - «Andreevsky monastery», based in 1648. (Fig. 2, 3). Also there the complex of buildings of Presidium of the Russian Academy of Sciences, constructed in 70-80th years of 20-th century (Fig. 4), bridge with station of underground "Vorob'yovy mountains" and a sports complex are located. Landslide slope (Fig. 5) is in an active condition. In June 2007 a rather big landslide took place there near ski-jump (Fig 6). Another landslide site is in a southeast part of Moscow near museum - reserve "Kolomenskoye" (Fig. 7, 8, 9). Last serious activation of a landslide has taken place there in 2002. Catastrophic activation of the deep blockglide landslide in the area of Khoroshevo on the left-hand shore of the Moskva River at Karamyshevskaya embankment took place in 2006-2007. Deep landslide activation was in Moskvorechye area in September 2009. Such complicated situation demands development of new investigations of landslide prone zones [1-4].

### **Mechanical-mathematical model for landslide movement**

One of methods of studying of landslide processes is mechanical-mathematical modelling of gravitational movement of matter on landslide a slope. At different stages of the development the landslide process can be described by various mechanical and rheological models. At the stage of formation of cracks, losses of stability, break of blocks the models of the elastic medium and model of destruction are applied. During slow movement of soil on the slope the model of high viscous incompressible fluid can be applied. Such model allows to estimate velocities of movement in a layer and to compare them to results of monitoring. Boundary conditions of a problem thus also depend on a concrete situation. So, in case of slow movement on the bottom border of a layer the condition of sticking is used. If the process of debris flow, underwater landslip or snow avalanche is considered, the condition of sliding or more complex boundary condition is possible on the bottom border. The choice of adequate model of process and statement of initial and boundary conditions is an independent mechanical problem.





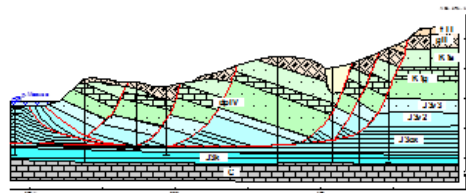
**Fig. 2. Vorob'yovy mountains.**



**Fig. 3. Andreevsky monastery.**



**Fig. 4. Presidium of RAS.**



**Fig. 5. Schematic cross-section of landslide slope at Vorob'yovy mountains.**



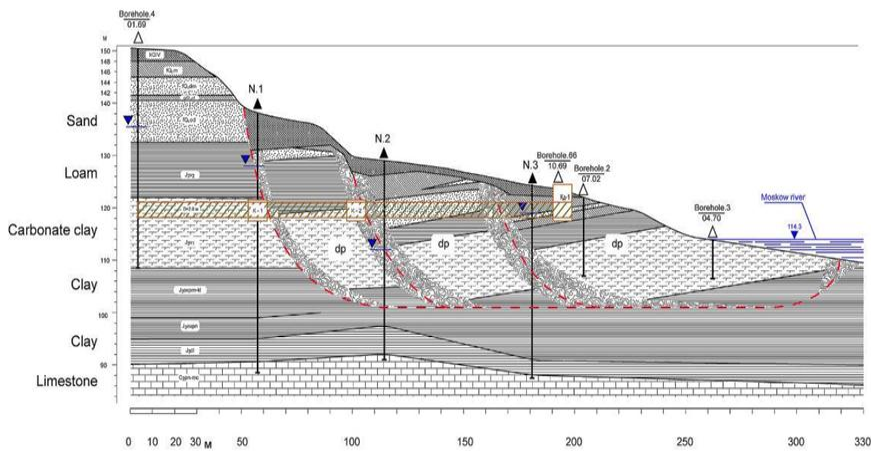
**Fig. 6. Ski jump.**



**Fig. 7. Museum - reserve "Kolomenskoye". Common view.**



**Fig. 8. Museum - reserve "Kolomenskoye".  
The church of Beheading of the Honest Head of Iowan Predecessor.**



**Fig.9. Deep blockglide landslide.  
Moscow, Kolomenskoye. N.1, N.2, N.3 - extensometers,  
inclinometers.**

Let's consider movement of landslide masses on a slope as movement of high viscous incompressible fluid described by equation of Navier-Stokes and continuity:

$$\frac{d\vec{v}}{dt} = \vec{F} - \frac{1}{\rho} \text{grad}p + \frac{\mu}{\rho} \Delta \vec{v}$$

$$\text{div } \vec{v} = 0$$

$\vec{v}$  – vector of velocity,  $F$  – force of gravity,  $p$  – pressure,  $\rho$  – density,  $\mu$  – viscosity,  $t$  – time.

Let the characteristic horizontal scale of a body of landslide  $L$  considerably surpasses its thickness  $h$ . We shall count also a landslide extended enough in the plan that allows to consider three-dimensional model as two-dimensional one for sections of landslide bodies. Following works [5-7] and applying a method of decomposition on small parameter, it is possible to get the equation of continuity and an approximated equation of the Navier-Stokes in dimensionless form for slow motions in a thin layer:

$$\begin{cases} \frac{\partial P}{\partial X} = \alpha \mu \frac{\partial^2 U}{\partial Z^2} \\ \frac{\partial P}{\partial Z} = -\rho \end{cases}$$

$$\frac{\partial U}{\partial X} + \frac{\partial W}{\partial Z} = 0$$

$P$  – is dimensionless pressure,  $U, W$  – dimensionless velocities,  $F$  – Frude number,  $R$  – Reynolds number,  $\rho$  – density,  $\mu$  – viscosity,  $\rho_0, \mu_0, u_0$  – scales of density, viscosity and velocity.

$$F = \frac{u_0^2}{gL}$$

Then it is possible to get the velocities and pressure in the layer:

$$\alpha = \frac{F}{R \left( \frac{h}{L} \right)^3} \qquad P = \rho (\zeta^* - Z)$$

$$R = \frac{u_0 L \rho_0}{\mu_0}$$

$$U = U_0 + \frac{\rho}{2\alpha\mu} \frac{\partial \zeta^* \mu_0}{\partial X} \left[ (\zeta^* - Z)^2 - (\zeta^* - \zeta_0)^2 \right]$$

$$W = W_0 + \frac{\partial U_0}{\partial X} (\zeta_0 - Z) + \frac{\rho}{\alpha\mu} \frac{\partial^2 \zeta^*}{\partial X^2} \left[ \frac{1}{6} (\zeta^* - Z)^3 + \frac{1}{3} (\zeta^* - \zeta_0)^3 - \frac{1}{2} (\zeta^* - Z)(\zeta^* - \zeta_0)^2 \right] +$$

$$\frac{\rho}{2\alpha\mu} \left( \frac{\partial \zeta^*}{\partial X} \right)^2 (Z - \zeta_0)^2 + \frac{\rho}{\alpha\mu} \frac{\partial \zeta^*}{\partial X} \frac{\partial \zeta_0}{\partial X} \zeta_0 (\zeta^* - \zeta_0)$$



$\zeta_0$  – the bottom border of a layer,

$\zeta^*$  – the top border.

Let on the bottom border the condition of sticking is satisfied:

$$U_0=W_0=0$$

The discharge of matter along the layer is:

$$Q = \int_{\zeta_0}^{\zeta^*} U dZ = -\frac{\rho}{3\alpha\mu} \frac{\partial \zeta^*}{\partial X} (\zeta^* - \zeta_0)^3$$

Since  $Q = \text{const}$  lengthways  $X$ , then:

$$\frac{\partial Q}{\partial X} = 0$$

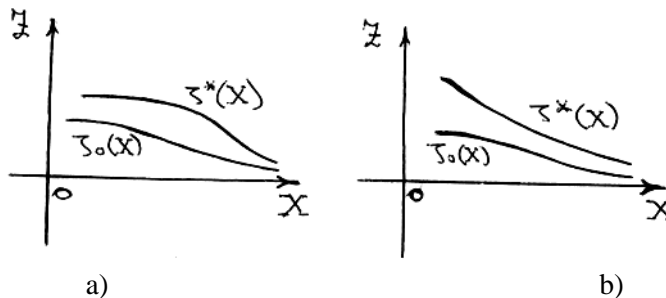
$$\frac{\partial^2 \zeta^*}{\partial X^2} (\zeta^* - \zeta_0)^3 + \frac{9\alpha\mu Q}{\rho} \left[ \frac{3\alpha\mu Q}{\rho} + (\zeta^* - \zeta_0)^3 \frac{\partial \zeta_0}{\partial X} \right] = 0$$

The condition of convexity of upper boundary is:

$$\frac{\partial^2 \zeta^*}{\partial X^2} < 0 \Rightarrow$$

$$\frac{3\alpha\mu Q}{\rho} > -(\zeta^* - \zeta_0)^3 \frac{\partial \zeta_0}{\partial X}$$

This expression enables to analyze the form of the surface of moving matter (Fig. 10).



**Fig. 10. The various possible form of landslide surfaces: a) convex, б) concave.**

Structure of clinoforms (convex) can arise, if:

1.  $Q$  is large, that is flux is high
2.  $\mu$  is large. It means that matter spreads bad and can support big angle
3.  $\rho$  is small. It means that matter has large specific volume and is friable
4.  $\text{grad } \zeta_0$  is small, that is angle of lower boundary is small
5.  $(\zeta^* - \zeta_0)$  is small, that is thickness of sedimentary layer is small. Under fixed  $Q$  it means that velocity of flux is high and formation of clinoforms and even overturning of rocks are possible

All these conditions seem to be natural enough to an explanation of formation of structures such as inflows and clinoforms of sedimentary cover that speaks about correctness of the model.

It is important to define the place of maximal velocity on the slope. An optimum place for location of monitoring post is the point of maximal speeds of movement of masses of landslide.

Let's consider the massif of sedimentary rocks with the top border  $\zeta^*$  representing landslide slope. The bottom border  $\zeta_0$  is compatible with an axis  $X$ . The maximum of horizontal speed  $U$  is reached on the top border  $\zeta^*$  of the massif owing to condition:

$$\frac{\partial U}{\partial Z} = -\frac{\rho}{\alpha\mu} \frac{\partial \zeta^*}{\partial X} (\zeta^* - Z) = 0 \Rightarrow Z = \zeta^*$$

Point of the maximal horizontal speed on the surface  $\zeta^*$  can be found from a condition of equality to zero of the first derivative:

$$\frac{\partial U^*}{\partial X} = 0, \text{ where } U^* = -\frac{\rho}{2\alpha\mu} \frac{\partial \zeta^*}{\partial X} (\zeta^*)^2$$

From here it is easy to receive the condition:

$$\frac{\partial^2 \zeta^*}{\partial X^2} \zeta^* + 2\left(\frac{\partial \zeta^*}{\partial X}\right)^2 = 0 \tag{1}$$

It is necessary to mean, that  $\zeta^*(X)$  is known function – the surface of landslide slope. And the received condition allows to find a point on a slope where speed of movement is maximal.

Let's consider for presentation and an illustration of the received decision the surface of a landslide as (Fig. 11):

$$\zeta^*(X) = -thX + 1$$

Then the condition (1) gives:

$$th^2 X - thX - 1 = 0$$

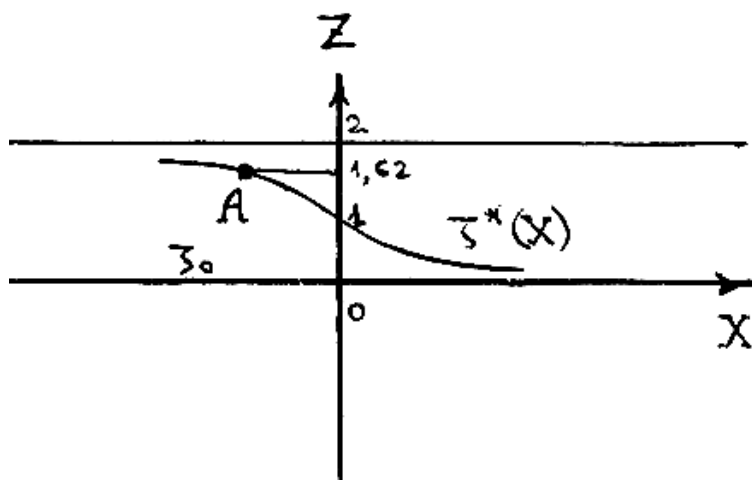
Whence we receive

$$thX = \frac{1 - \sqrt{5}}{2}$$

and

$\approx 1,62$

$$\zeta^* = \frac{1 + \sqrt{5}}{2}$$



**Fig. 11. Point A of the maximal horizontal speed of movement of masses on the surface of slope.**

Such position of the point of the maximal horizontal speed is represented real, and more exact data on a structure of landslide and its surface will enable to define such point on a concrete slope. The point of maximum of speed on a slope defines the place of possible failure of a landslip in case of achievement of limiting pressure in massif of rocks. There could be several points of local maximum of speed on a slope, that characterizes an opportunity of failure of a landslip on each terrace of a slope. The places of minimum speed can be used for building constructions and oil-gas pipelines. Model velocities of matter can be compared with real velocities that give possibility to calibrate the monitoring equipment and define the real mechanical parameters of media.

### **Conclusions**

Landslides process is one of the most widespread and dangerous processes in the urbanized territories. The landslide process activization took place in Moscow last years. Such complicated situation demands development of new investigations of landslide prone zones. Mechanical-mathematical model of high viscous fluid is elaborated for simulation of matter movement on landslide slopes. The results of modelling give possibility to investigate some fundamental aspects of material behaviour of landslide. The results of modelling give possibility to define the place of highest velocity on landslide surface, which could be the best place for monitoring post position. Model can be used for calibration of monitoring equipment by comparison of model and real velocities.

### **References**

1. Kutepov V.M., Sheko A.I., Anisimova N.G., Burova V.N., Victorov A.S. et al. (2002). Natural hazards in Russia. Exogenous geological hazards. Moscow, "KRUK", 345 p.
2. Osipov V.I., Shojgu S.K., Vladimirov V.A., Vorobjev Yu.L., Avdod'in VP et al. (2002). Natural hazards in Russia. Natural hazards and society. Moscow, "KRUK", 245 p.
3. Postoev G.P., Svalova V.B. (2005). Landslides risk reduction and monitoring for urban territories in Russia. Proceedings of the First General Assembly of ICL (International Consortium on Landslides), "Landslides: risk analysis and sustainable disaster management", Washington, USA, Springer, pp. 297-303.
4. Svalova V., Postoev G. (2008). Landslide Process Activization on Sites of Cultural Heritage in Moscow, Russia. Proceedings of the First World Landslide Forum 2008, Tokyo, Japan, 4p.

5. Svalova V.B. (1992). Mechanical-mathematical models of the formation and evolution of sedimentary basins. *Sci.de la Terre, Ser. Inf., Nancy*, 31, pp. 201-208.
6. Svalova V.B. (1993). Mechanical-mathematical simulation of geological structures evolution. *Geoinformatics*, v. 4, N3, pp. 153-160.
7. Svalova V.B., Sharkov E.V. (1992). Mantle diapirs and surface depression in back-arc areas: a rheological model. *Ofiolity*, 17/1/, pp. 165-170.

## **CONSIDERATION OF EXTREME HYDRO-GEOLOGICAL EVENTS IN NUMERICAL FORECASTS OF HYDRO-GEOLOGICAL CONDITIONS CHANGE IN THE TERRITORY OF IMPORTANT INFRASTRUCTURE OBJECTS**

**<sup>1</sup>Gleb Batrak, <sup>2</sup>Stanislav Semenov, <sup>3</sup>Stanislav Seleznev, <sup>4</sup>Irina Galitskaya**

*<sup>1,2,3,4</sup>Institute of Environmental Geoscience RAS, Moscow, Russia*

*<sup>1</sup>glebbatrak@rambler.ru*

According to the Russian standard documents at designing a possibility of change of hydro-geological conditions on the site in the course of construction and operation of buildings should be considered. One of principal causes of the given changes is natural seasonal and long-term fluctuations of ground water's level. Natural fluctuations are complicated by the time variability caused by factors of urbanization in city. The different time data about geological conditions and ground water's level position is used at construction of hydrodynamic models of ground water. It is incorrect to use this data without recalculation it by uniform time. It is also necessary to note an absence of good methodical base for manufacture of long-term hydro-geological forecasts of satisfactory accuracy. The most convenient and informative way of data presentation about hydro-geological conditions changes is the estimation of extreme maximum and minimum possible levels of ground water and also a position of the level received at researches in this range. Extreme levels are made by calculation in which the data of single observations in concrete wells is a necessary component. Maps of hydroisohypses for extreme positions of level in the given territory are constructed on the basis of the processed data. Use of this data as initial at hydro-geological models making allows to estimate influence of a projected construction on ground water in the greatest possible range. This method gives priority in comparison to the decision of a non-stationary filtrational task as complexities with an estimation of accuracy and reliability of the

received forecasts are difficultly surmountable in this case. Especially it concerns the urbanized territories characterized by the broken ground water's regime. The range estimation allows to consider all possible changes of environment at various positions of ground water level. It also gives good base for the further construction of more exact forecasts in case of increased requirements to accuracy.

### Technique of Drawing up of Numerical Band Forecasts With Use of Extreme Groundwater Levels

The technique has been applied for the prediction of the hydrogeological conditions in the construction of the 3,5 km automobile tunnel in Moscow. Building of a tunnel site as a part of two tunnels (a direct and return direction of movement of motor transport) is provided in the underground and partially open way. The line of a projected tunnel crosses a river Chertanovka valley (Fig. 1, 2).

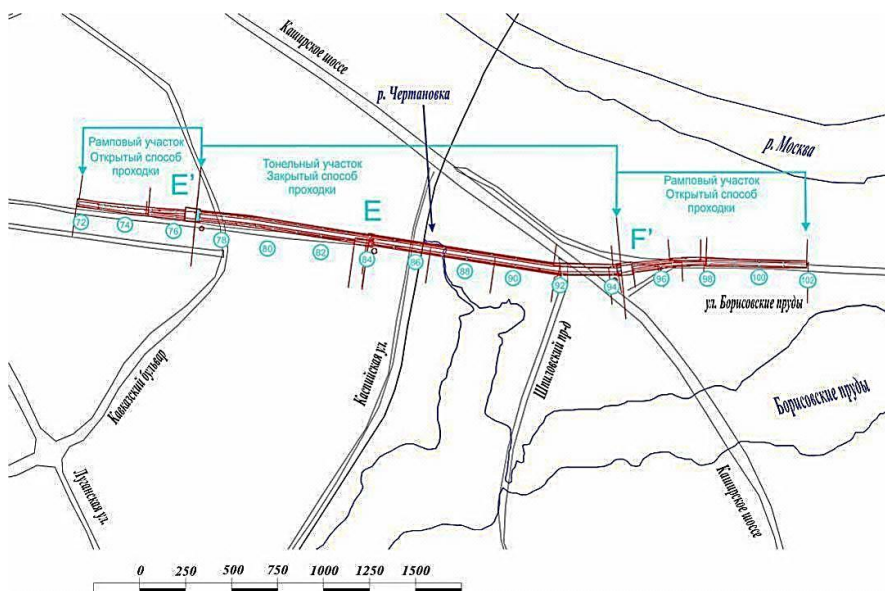
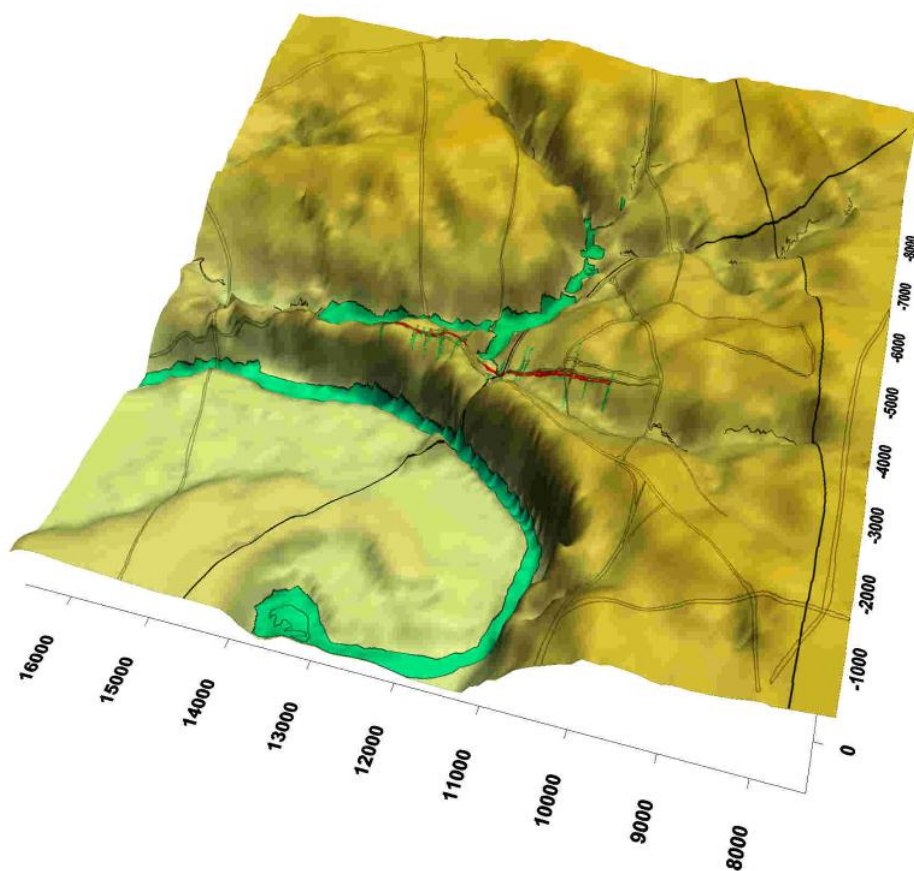


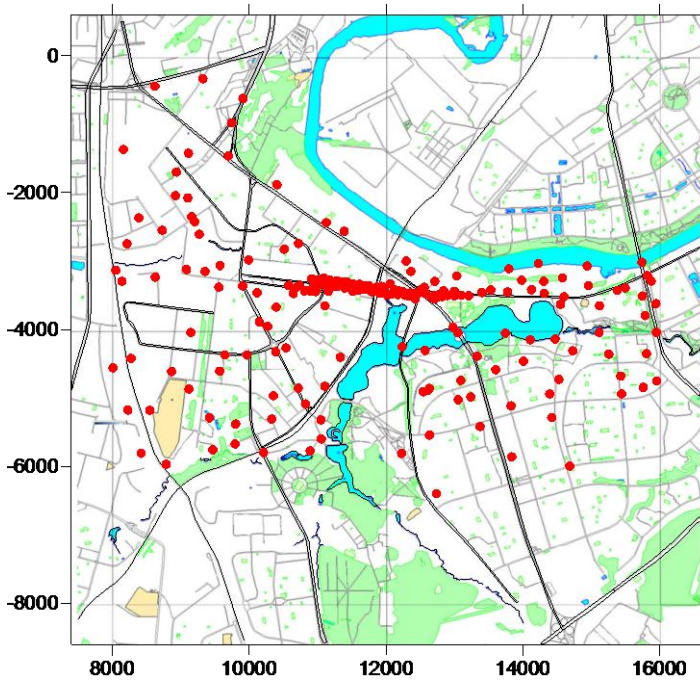
Fig. 1. The situation



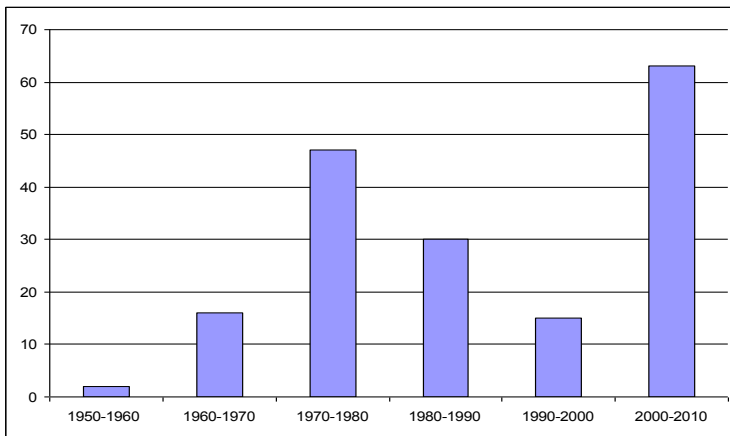
**Fig. 2. The 3D relief**

Prominent feature of the given project is that the geological and hydro-geological information is non-uniform and non-uniformly distributed on research territory. Drilling of wells was made by various organizations at the different periods of time. Not all materials of researches contain hydro-geological information (Fig. 3, 4). Most detailed information is available along a building line in regular intervals (Fig. 5). In adjoining

territory share wells have been involved the part from which has been passed more 30-40 years ago. Wells are essentially non-uniformly distributed in time.



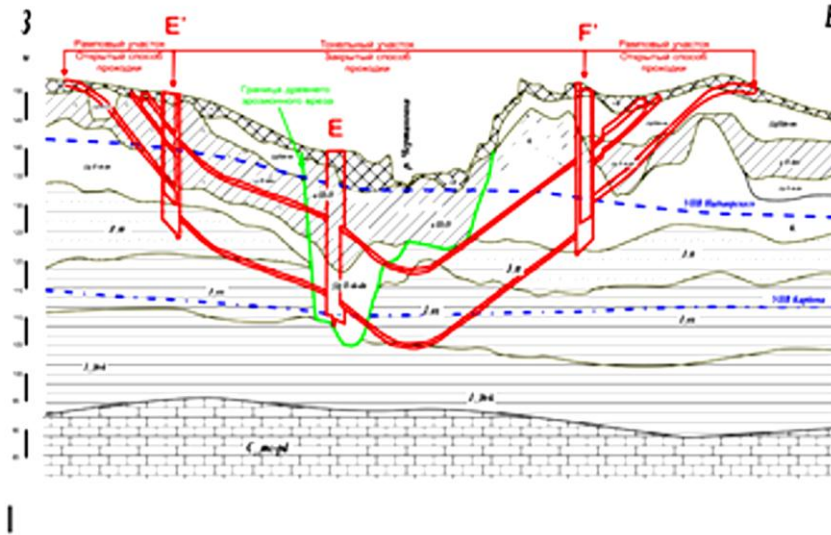
**Fig. 3. The initial data distribution**



**Fig. 4. The distribution of drilling time**

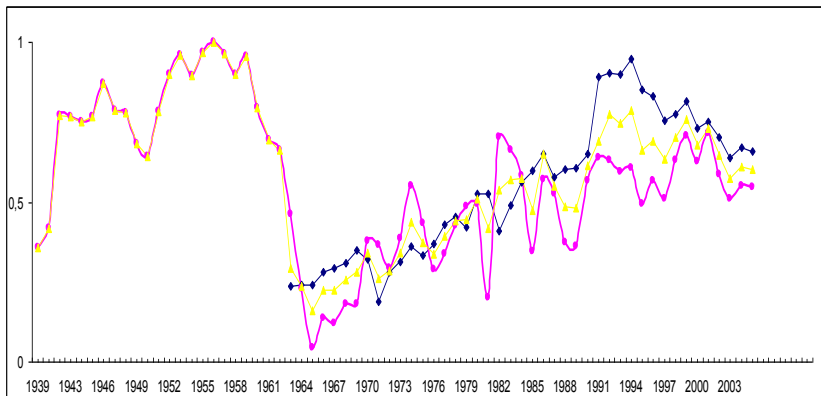


Hydro-geological forecasts for definition of ground-water levels are carried out on the basis of long-term data of groundwater regime on investigated catchment basin. In this case the interfluvium of the rivers of Moscow and Gorodnya was used.



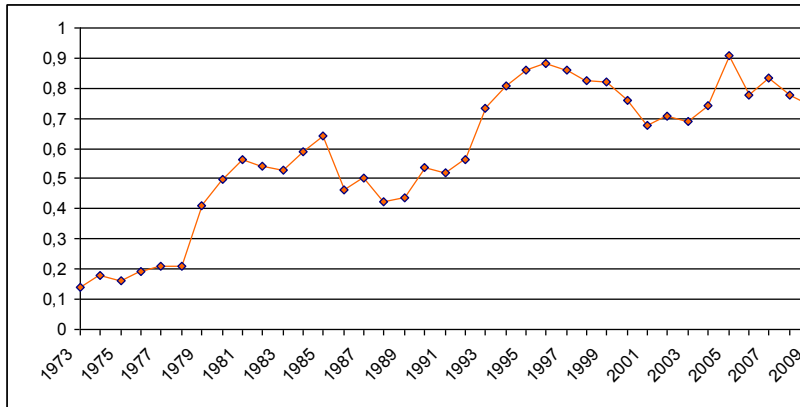
**Fig. 5. The section along the tunnel**

To consider the data of researches in calculations on the basis of regime supervision, it is necessary to spend lengthening of existing lines of supervision at least till the moment of carrying out of researches (Fig. 6).

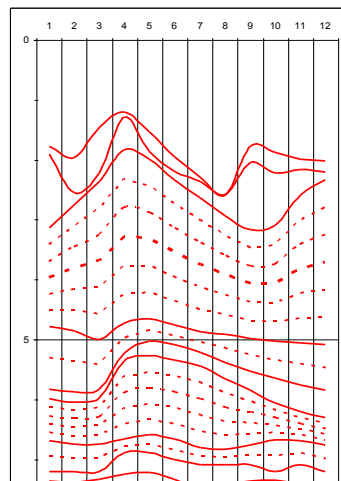


**Fig. 6. Long term annual normalized groundwater regime**

Daily measurements of precipitation and temperature in Moscow territory have been involved. These factors are the most informative concerning variability of ground water regime as characterize recharge and evaporation (Fig. 7). The technique is based on use of look-ahead-information nomograms which allow to define groundwater level position according to single measurements of last years. Prediction can be created for any date in a month. The authentic single measurement fixed in the course of drilling is sufficient (Fig. 8).



**Fig. 7. Long term annual normalized groundwater regime prolonged with precipitation data.**

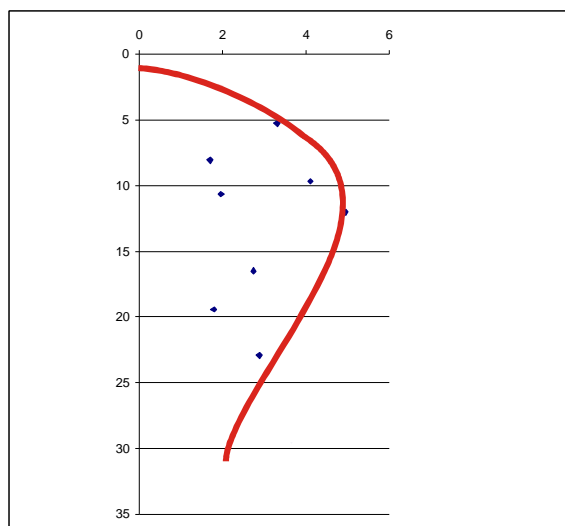


**Fig. 8. Seasonal regime nomograms with depth (months, depth (m))**

The information-look-ahead nomograms is a family of typical seasonal modes for all intervals of depths of ground waters, characteristic researches for area with reference to the most widespread geo-lithologic complexes. In a general view the nomogram can be considered as the original passport characteristic of seasonal natural regime of ground waters of certain region. The most important stage of hydro-geological forecasting is entering into calculation of the amendments considering long-term amplitude of fluctuations (Fig. 9). Long-term amplitudes bring rather essential contribution to the general scope of fluctuations. The form of the graphic genetic law showing how ground waters level depth corresponds this or that long-term amplitude was made. Look-ahead calculation is carried out for each prospecting well separately. The maps of maximum and minimum possible groundwater levels were constructed (Fig. 10, 11).

### **Methodology of numerical simulation**

The territory of a large megacity as Moscow is characterized by difficult hydro-geological conditions. On the one hand the Moscow region in the hydro-geological relation represents the river basin of the Moscow-River characterized rather good drainage features due to powerful layers of high permeable alluvial and glacial rocks.



**Fig. 9. Distribution of long-term amplitude of groundwater with depth, m.**

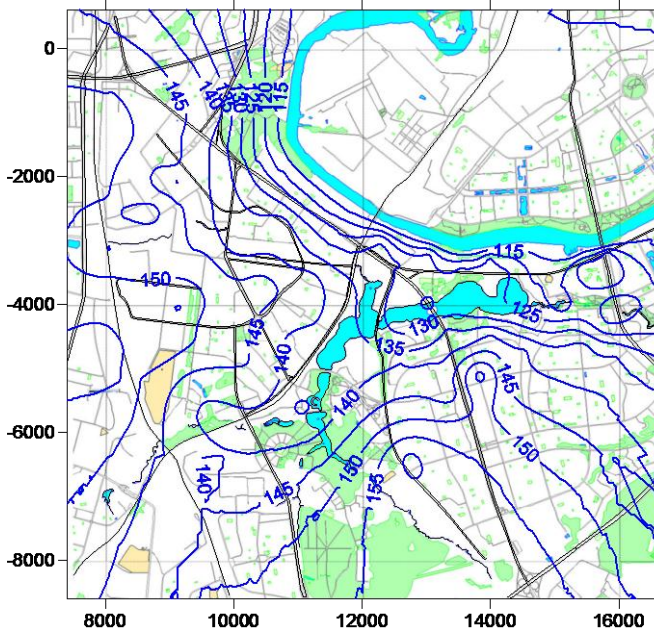


Fig. 10. Minimum possible groundwater level

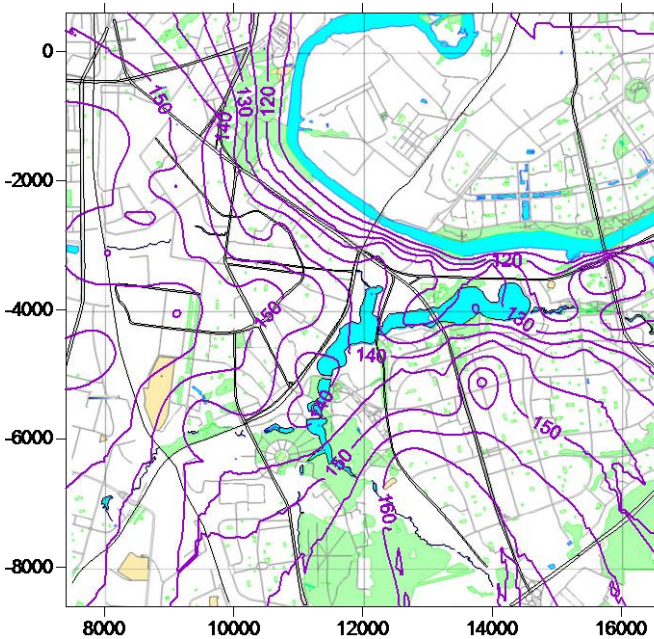


Fig. 11. Maximum possible groundwater level

On the other hand presence of a clay cover in South and West together with low absolute marks and a rare erosive network in the East make possible conditions for flooding of 40 % of the city territory. Other important complicating moment is set of factors of the urbanization influencing a relief, filtration properties of environment, recharge and discharge conditions, hydrochemical regime and so on. Researches show that natural factors in the city territory dominates, however, artificial factors transform them strongly enough. In the geological relation the territory of Moscow is studied more than hundred years. Now the huge geological data – about one million wells, supervision on a network of more than three hundred hydro-geological regime observation posts, technical characteristics of many city objects influencing surrounding geological environment is accessible. At the same time to consider in prognostic model all set of versatile factors of influence it is difficult enough even when there is an exhaustive information on these factors. It becomes especially important at designing of large or extended object which gets at once to a zone of influence of variety of the natural and artificial factors non-uniformly distributed on the area and in time. Similar complexity of reproduction of hydro-geological conditions and factors of formation of ground waters regime in aggregate with high requirements to speed of performance of works and accuracy of result has made rather popular use of computer programs for the numerical decision of the differential equations used for calculation of a filtration and migration in porous environments, and also means of input and output of the information. In our calculations we use program MODFLOW 2000 developed by the American geological survey. For work with program MODFLOW 2000 the license program of input, preparation and a conclusion of results Visual Modflow by Waterloo Hydrogeologic [1] was used. Use of similar optimized under the user, hi-tech software on the one hand yields the geologist the powerful tool for fulfillment of calculations, but on the other hand creates illusion high possibilities. In these conditions the competent schematization of hydro-geological conditions and verification of results become the major procedures. A question of graphic presentation of forecasting results which should be accessible to a wide range of experts, including architects, designers and experts also rises.

### **Features of hydro-geological conditions**

Long-term experience of making up of numerical hydro-geological models in aggregate with acquaintance and examination of the models executed by other organizations of a geological profile, have allowed to reveal a number of characteristic rules of hydro-geological conditions schematization and the task for models of technogenic loading. The following features of hydro-geological conditions which are necessary for considering at a geofiltrational schematization as a whole for the city territory of Moscow are the following:

- In an interval of depths in quaternary, cretaceous, jurassic, top - and middle coal horizons the four aquifers are allocated;

– Over moraine aquifer, as a rule, is sporadic and directly not always is set in the model.

– The over jurassic aquifer in most cases is the core on degree of rendering of influence on objects of a city infrastructure and is most subject to changes under the influence of these objects.

– The jurassic aquifer is presented more often low-power, but a layer of phosphorites possessing by very high filtrational properties of titon age. Aquifer is confined. Pressures are established on the same marks, as levels in over jurassic aquifer.

– On most parts of Moscow territory, excepting a part of rivers valleys of Moscow and Jauzy, over jurassic and titon aquifer are separated from coal aquifer by Jurassic clay.

– Characteristic feature of the Moscow river valley is ancient buried erosive valleys in which capacity of clays is essentially reduced up to their full absence. But even there, where capacity of clays remains enough big, erosive valleys carry out a role of linear ways of discharge of ground waters.

– The analysis of the data of deep drilling, and also the regional given absolute marks of levels of coal horizon in Moscow territory, has allowed to assume that on the most part of territory the levels of ground waters in over Jurassic aquifer are established above, than in coal, hence, there is a precondition of an overflowing of ground waters from top to down;

– The analysis of lines of ground waters equal pressure in over jurassic horizon has shown that regional movement of ground waters occurs in a direction from the basic areas of recharge which are situated in zones of high watersheds, to the basic drain – the river Moscow.

– Deformations of lines of an equal pressure are connected with local areas of a recharge and discharge. Besides, the stream of ground waters unloads in underlying horizons as a result of an overflowing. On separate sites with superficial level, dated for channels of the rivers, unloading is carried out as a result of evaporation from a surface of ground waters.

### **Schematization of hydro-geological conditions**

Basic elements of a geofiltrational schematization of hydro-geological conditions in Moscow are: a choice of a filtration regime in time, spatial structure of a stream, parameters of water-bearing system, boundary conditions.

#### **1. Model borders in the plan**

The sizes of settlement area of a filtration get out so that it should be possible to estimate influence of a construction on change of hydro-geological conditions on the

territory adjoining to a site. Practice of hydro-geological calculations for territory of Moscow has shown that the size of a zone of influence of objects on ground waters can be approximately in 3-4 times more than maximum size of a construction. Proceeding from its external borders of model also are accepted.

**2. Model borders on depth** are defined by characteristic depth of influence of construction on ground waters. As a rule, in case of absence of powerful sources of pollution the sole of that layer (aquifer or aquatard) into which the object directly takes root is accepted to the bottom border. More often the bottom border of model doesn't fall deeper than jurassic dividing layer. Considering a parity of pressures of ground waters in over jurassic and coal aquifers on a roof (or a sole) of clays the overflowing of ground waters from over jurassic aquifer downwards is set.

### **3. Use and the analysis of the initial geological information.**

In territory of Moscow a considerable quantity of the geological information received from researches of last years is accessible. It essentially facilitates creation of hydro-geological models as within the limits of engineering researches in the project of a concrete construction it is impossible to spend drilling on all area of model. The analysis of an actual material on the city territory has shown that the geological and hydro-geological information is non-uniform and non-uniformly distributed on research territory. Sites of woods and parks are most poorly characterized. Drilling of wells was spent by the various organizations to the different periods of time, not all materials of researches contain the hydro-geological information. As a rule, the building site is characterized also most in detail. In other territory the density of an arrangement of wells is much less. Quite often there is no data about drilling time. There are no data on hydro-geological parameters. The part of wells has been passed more 40-50 years ago, to a modern lay-out of territory. Nevertheless, spatial variability of lithological layers and depths of stratigraphic borders allows to describe adequately enough a geological structure of the top part of a section with accuracy, sufficient for the decision of tasks in view.

### **4. Filtrational parameters.**

As initial values of factor of a filtration values which are in a range of the data received as a result of researches are accepted. In the absence of experiments by definition of filtrational parameters within the limits of the given researches, results of last years are used.

### **5. Criterion of calibration.**

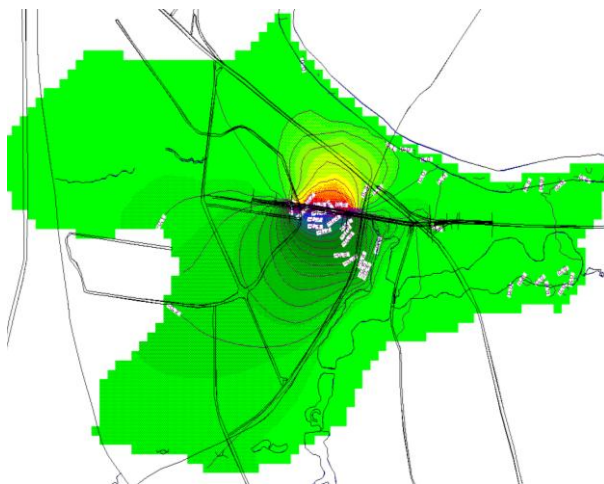
By the purposes or criteria of calibration of model divergences modelled and measured levels components about 10 % from the maximum difference of pressures in the field of a filtration, as a rule, are accepted. **Estimating quality of calibration of model it is necessary to note following objective reasons which can affect results:**

- There is a considerable quantity of archival levels of ground waters occurring at different times in wells both on a site of building and in adjoining territory;
- A part of archival wells was in territory which has undergone to building therefore the hydrological regime and absolute marks of a surface have been essentially changed that could affect change of pressures of ground waters;
- Not all researches were spent with identical quality – in some wells level was measured without waiting for its complete recovery.

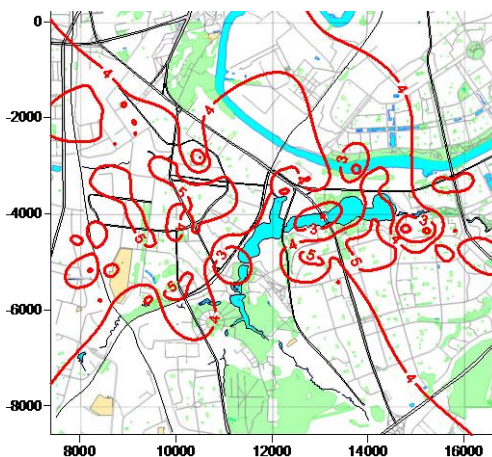
### **Interference kinds in system “ground waters – technogenic object”**

The joint analysis of technical decisions and environment of Moscow territory has shown that the basic possible negative consequences in building territories will be: (1) formation of depressions in ground-waters owing to water-extraction and (2) the barrier effect owing to settlement of a tunnel on the way of a stream of ground waters. Last is shown that in a face-to-face part of a stream there will be a lifting, and in rear – decrease in ground-water level. Depressions can have various depths and the planned sizes. They are defined by depth and duration of water-extraction and also its area and filtrational properties of rocks. The barrier effect usually leads to lifting of level a maximum on 1,0-1,5 m near to a construction (Fig. 12). Level decrease usually doesn't exceed one meter. For superficial constructions and the small planned sizes these values essentially are less. Influence on a river drain take place mainly for the small rivers and, as a rule, it is insignificant. The damage to a drain of the river will take place only in immediate proximity from a building site and less in a current. After the termination of civil work the drain in the river is quickly restored, as high gradients of a stream and high filtrational properties promote active inflow of water. Pollution of ground waters can occur basically as a result of receipt of polluting substances: 1) with the waters from territories of building sites and access roads, 2) with pulling up of river waters at carrying out water-extraction works. The results of numerical simulation shows that effect of human activity (Fig. 12) is smaller then the losses of accuracy owing to ignoring of natural fluctuation amplitude (Fig. 13).





**Fig. 12. Results of numerical simulation of barrier effect owing to a tunnel**



**Fig. 13. Difference between maximum and minimum possible levels, m**

### References

1. Harbaugh, A.W., and McDonald, M.G., 1996, User's documentation for MODFLOW-96, an update to the U.S. Geological Survey modular finite-difference ground-water flow model: U.S. Geological Survey Open-File Report 96-485, 56 p.

## **RETURNING THE EARTH TO MANKIND AND MANKIND TO EARTH: AN ECOSYSTEMIC APPROACH TO ADVOCACY, PUBLIC POLICIES, RESEARCH AND TEACHING PROGRAMMES**

**André Francisco Pilon**

*University of São Paulo, Brasil / Int. Academy of Science,  
Health & Ecology, Austria  
[gaiarine@usp.br](mailto:gaiarine@usp.br)*

### **Abstract**

In view of the overwhelming pressures on the global environment and the need to disrupt the systems that drive them, an ecosystemic theoretical and practical framework is posited for the evaluation and planning of public policies, research and teaching programmes, encompassing four dimensions of being-in-the-world (intimate, interactive, social and biophysical), as they combine, as donors and recipients, to induce the events (deficits/assets), cope with consequences (desired/undesired) and contribute for change (potential outputs). The focus is not on the “bubbles” of the surface (consequences, fragmented issues), but on the configurations deep inside the boiling pot where the problems emerge. The paradigms of development, growth, power, wealth, work and freedom, embedded at institutional and cultural level are considered, in view of environmental problems, quality of life and the state of the world. Instead of dealing with the bubbles (segmented, reduced issues) and trying to solve isolated and localized problems without addressing the general phenomenon, the proposal emphasizes the definition of the problems deep inside the “boiling pot”, where the problems emerge, encompassing the current “world-system” with its boundaries, structures, techno-economic paradigms, support groups, rules of legitimation, and coherence. In the socio-cultural learning niches, heuristic-hermeneutic experiences generate awareness, interpretation and understanding beyond established stereotypes, from a thematic (“what”), an epistemic (“how”) and a strategic (policies) point of view.

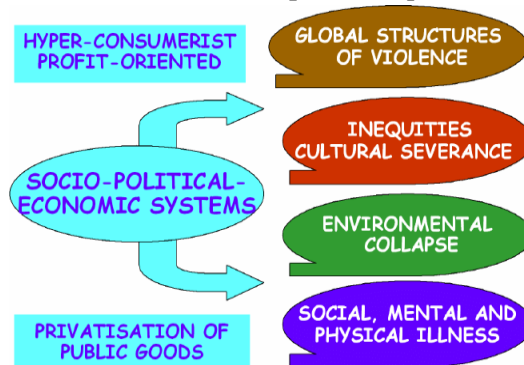
**Key words:** education, culture, politics, economics, ethics, environment, ecosystems.

### **1. INTRODUCTION**

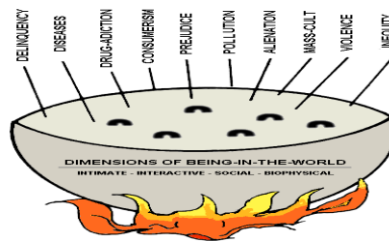
Contemporary problems are closely interconnected and interdependent, and cannot be understood and solved within the present context of weakening social bonds and cultural, political and economical clashes (Elohim, 2000), a generous ground for

market-place's manipulations, publicity-oriented interests, fragmented academic formats and private maneuvers. As a syndrome, not a set of separate phenomena, they reflect the interrelated pressures, stresses, and tensions due to an overly large world population, a pervasive and increasingly systemic environmental impact of economic activities, urbanization, consumerism, widening the gap between rich and poor, within and between countries (McMichael, 2013). The present crisis is a sign of the severe cultural predicament of our times and reflects the deceptive maneuvers and collusions of political and economical dominant groups /1/, a prior disordering of thought, perceptions and values (Orr, 1994), the stronghold of national and international corporate interests, which break through the core of all societal institutions. Deforestation, desertification, global warming, biodiversity losses are linked to powerful economical and political interests, which define every aspect of humanity and nature as part of the market rubric (Irwin, 2007), legitimising business expansion in terms of consumerism and abuse of natural resources /2/- increasing inequalities, violence and poor quality of life throughout the world. Environmental impact studies should not be treated as a mere formality, development strategies rooted in mega-projects disregard fundamental human needs and ignore the principle of "right relationship", which respects the integrity, resilience, and beauty of human and natural environments as the foundation for a new economic order (Brown and Garver, 2009). In "asymmetrical societies" (Coleman, 1985), large differences in power between natural persons and legal persons (individuals and enterprises), allow business corporations to have a substantial influence on public policies and State affairs, as they diffuse responsibility along hierarchical structures and safeguard their shareholders as mere investors in the financial markets. /3/. Privatisation and deregulation reduce the role of governments at national and international levels, and hence weaken mandatory powers over environmental standards; the dominant approach to the environment by corporate, state and international authorities shows that present conditions are outcomes of the undesirable impacts of overall policies and market conditions (Robbins, 2004). The current "world-system" has boundaries, structures, member groups, rules of legitimation, and coherence; "it is made up of the conflicting forces which hold it together by tension and tear it apart as each group seeks to remold it to its advantage; it has a life-span over which its characteristics change in some respects and remain stable in others" (Wallerstein, 1974: p. 347-57). Trying to solve isolated and localized problems, without addressing the general phenomenon (which has the conditions to solve specific problems), is a "conceptual error" (Volpato, 2013). The purpose is to move away from human behaviour approaches (Shove et al, 2012) and techno-economic paradigms that obscure government's role in sustaining unsustainable economic institutions and ways of life. The conceptual direction and the legitimacy of development strategies should be based on a comprehensive framework; instead of

surrendering to specialisation and fragmentation, a “new global covenant” should be carefully planned (Held, 2004), emphasizing social justice, physical, social and mental wellbeing and the equilibrium between natural and built environments. The environmental crisis (fig. 1) “stems from the prevailing power-driven ethos, the anomic individualism, which divert human concern into technological invention, scientific advancement, and unlimited material consumption and production” (Orhan, 2003).



**Fig.1. Consequences of current socio-political-economical systems for the quality of life**



**Fig.2. The real problems lie deep inside the boiling pot, not in the bubbles (effects)**

The focus should not be on the “bubbles” of the surface, (consequences), but on the configurations deep inside the boiling pot (fig. 2). These bubbles have dynamic properties (Pilon, 2009), they co-exist among many others in a cluster, as the collection of all factors affecting health, environment, working conditions, economy, education, culture, etc.; each bubble is influenced directly by a companion bubble's interface but also indirectly through the companion bubble's connections to other surfaces (Wilcox 2007).

Cultural, educational, social, economical, environmental and health problems

cannot be sorted out by segmented projects, without considering micro, meso and macro relationships. Like bubbles in the surface of a boiling pot, segmented problems are symptomatic of the assemblage of political, economical, social and cultural variables that should be dealt with altogether. The role of law, the work of attorneys and judicial courts is hampered by the very system in which they have their insertion, "legal" and "illegal" strategies are mixed together in the assemblage of political and economical interests; powerful lobbies, deeply ingrained in the public administration, favour mega-projects with intensive use of resources, rather than the appropriate technologies. Beyond profit-searching motives of business corporations and other vested interests, transboundary issues like human rights, pollution, deforestation, drugs and criminality impose a significant reconfiguration of state control and political authority, in which power must be shared on ethical grounds in a transnational basis, by transnational organisations. To cope with environmental collapse /4/, environmental justice should be extended beyond national boundaries, beyond political and economical interests of malicious consortia and corrupted or lenient governments, which easily comply to ill-intentioned propaganda and lobbying by influential groups and questionable business organizations. Territorial and jurisdictional aspects are fundamental in terms of governance (Ashley, and Crowther, 2012); political and cultural forces blunt our response to the growing complexity of ecological catastrophe (Buell, 2003), which cannot be understood or resolved without dealing with deep-seated problems within society and its amoral political-economical system (Bookchin, 1982). Legal procedures will not forestall the planned obsolescence of products designed for the dump, nor the perceived obsolescence fostered by propaganda induced consumerism, which arise in people the sensation that products should always be substituted by new ones, buying and disposal converted into rituals of a culture that makes consumption a way of life (Foster and Clark, 2012). Transboundary and global environmental harm present substantial challenges to state-centered (territorial) modalities of accountability and responsibility; the globalization of environmental degradation has triggered regulatory responses at various jurisdictional scales to address "accountability deficits" in global environmental politics" (Mason, 2008). Cultural and educational policies succumb to the prevailing political and economical interests, converting the population into consuming subjects, appropriating their thoughts and bodies as commodities of influential people and questionable business corporations, which use propaganda, lobbying and corruption to intensify profits and secure their hegemony over public affairs. The cultural environment, a common ethical ground, is more important than the best legal prescription: the focus should not be on consumer's behaviour, but on the economic and political background, on the marketing and advertising impact of mass-media in public opinion about products, services and lifestyles, on its social and cultural

embeddedness. The emphasis on human rights, rather than collective political action, only reiterates individualistic approaches (Harvey, 2005). The fundamental change is economic, social, cultural and political; priority should not be given to growth, but to sustainability, human development, order and stability in civil society: if one group gets richer, others can be used and discarded (Bown, 2007). Addressing structural exclusion through legal, social, or economic inclusion, such as civil rights, social norms, or the market-oriented educational system in view of the expansion of the middle class do not change the bigoted paradigms of development, growth, power, wealth, work and freedom embedded into the political, economic and cultural institutions. "Social inclusion" only accommodates people to the prevailing order and do not prepare them to change the system (Labonte, 2004); once "included", a new wave of egocentric producers and consumers (Chermayeff and Tzonis, 1971) reproduce the system responsible for their former exclusion, increasing the abuse of nature in the name of "progress". Growth, power, wealth, work and freedom must acquire new meanings (O' Sullivan, 1987). The accumulation of wealth to the exclusion of other components of the development process (safety, health, education, equity, ethics, justice, beauty) has led to natural devastation and severe social and cultural impacts, with high levels of crime and violence in the so called "emerging countries". Privatisations, deregulations, market-oriented reforms, resulted in relinquishing state's control to the huge power of private sectors; new technological waves will not rescue a devastated environment, nor relieve the effects of inequities, uprootings, displacements, hunger, violence, ecological insults and deep social division (Am. Anthr. Assoc, 2005). When the political, economical, cultural and ethical disarray normalizes or condones inequities, transgressions, violence and atrocious behaviours, questions of ethical, moral and overall civic education are frequently left aside, while information and communication technologies are presented as a panacea for all evils. Within one generation, the gap due to the lost of value systems (specially religion and ideology) has been filled by the prevalent ideology of the market; in the lack of an alternative value system, /5/ religious biased sects, in the urban areas, reinforce the idea that political and economical success, in the current system, is a sign of divine blessing. In many problem-ridden, economically unequal and intrinsically violent cities of emerging countries, most people become uninvolved in civic life due to the outspread criminality (Baiocchi, 2005): while some enjoy life in fortified enclaves most of the city dwellers live in makeshift slum housing, without the basic social services (health, education, police authority, etc.). /6/ This goes along with turmoil, uncertainty, lack of confidence, fear and impotence (Rotmans and Loorbach, 2009). The more the city concentrates the necessities of life the more unlivable it becomes; the notion that happiness is possible in a city, that urban life is more intense, pleasure enhanced, and leisure time more abundant is only

mystification and a myth (Lefebvre, 2003). Development proposals, technological “solutions”, often ignore social, cultural and environmental impacts, binding nature as natural capital with financial domains (Sullivan, 2013), demanding even more resources and increase pollution and waste without changing the irrational system of production, transport and consumption that plagues the world. /7/ Advances in applied ethics by thoughtful and innovative thinkers encompass different professions, working together, within a multidisciplinary approach, basing their action on some common principles of ethics and on an understanding of each others' obligations, responsibilities and professional standards (Soskolne, 1997). Development as plunder (White, 1999; Trainer, 2000), implies systemic risks (Giddens, 2001), global catastrophes (Bostrom, 1997), simultaneous crisis formation (Harvey, 2006), global and integral accidents (Virilio and Turner, 2005), total risk of catastrophe (Ewald, 1997), general disaster (Massumi, 2003), the worst unimaginable accidents (Beck, 2007). If pressures on systems steadily increase, “catastrophic bifurcation” can appear without obvious early warning signals, /8/ and the resulting changes are always difficult to reverse; understanding how such transitions come about in complex systems such as human societies, ecosystems and the climate is a major challenge (Scheffer et al., 2001). “Sustainability” based on capital and technology, cannot be a substitute for the resources drawn from the natural world: “strong sustainability” entails containing population growth and curbing consumption, meeting the needs of the current generation as opposed to their demands and living within the productive capacity of nature (Layzer, 2008). Development must be based on the satisfaction of fundamental human needs, on growing self-reliance, on the construction of organic articulations of people with nature and technology, of global processes with local activity, of the personal with the social, of planning with autonomy, and of civil society with the state (Max-Neef, 1991). Weak public institutions and deeply entrenched networks act together to prevent accountability, funneling finance and influence along unofficial channels for the benefit of corrupt groups; politicians participate in governmental processes primarily to secure and retain access to personal enrichment at the expense of the public good (Whitton, 2009). Impersonal institutions and formal rules, creating trust at systemic (versus idiosyncratic) levels and reducing individual marginal transactions in a relationship-based regulation system, is mandatory to a major institutional change: institutions for risk-sharing at a systemic level decrease individual risk and allow longer time horizons” (Meisel, 2004). Institutions provide the rules of the game in society, the humanly devised constraints that shape human interaction (North 1990); they stabilize the behavior and interaction of agents, create predictability and decide how authority is constituted, exercised, controlled, and redistributed (March and Olsen, 1989). Environmental issues cannot be assessed ignoring questions of wealth and power and

the divergent priorities which beset politics (Rabkin, 2008). Private consumption at the cost of nature is to a large extent a cultural activity linked to the emergence of the knowledge economy, “with returns in the form of profits instead of wages” (Huppés, 2008). Cross-cutting programmes on sustainable development imply a worldwide change of focus and procedures in different areas of production, distribution, consumption and discard. This is not only a matter of education, /9/ but of governance and societal organization against entrenched economic and political forces that are too powerful to succumb to a direct attack by “civil society” or “global citizens movements” (Winston, and Edelbach, 2014).

## **2. AN ECOSYSTEMIC APPROACH FOR PUBLIC POLICIES, RESEARCH AND TEACHING**

Understanding a problem is to understand the relationships between the events and the context in which these relationships occur. People with different values interpret the "same" evidence in different ways (Kahan, 2012), the information has a minor role compared to emotions, values and ethics (Etzioni, 2003; Dietz, 2011). The enlightenment ideal that “informed” people opt for the common good is still a philosophical ideal. Ecological behavior is linked to positive social involvement: in contrast to “extrinsic” goals, like money, image and status (which are means to other disputed ends), “intrinsic” goals are inherently gratifying to pursue, like self-acceptance (growing as a person), affiliation (having close, intimate relationships), community feeling (helping the world be a better place) (Kasser & Ryan, 1996). Change depends on a critical, collective and connective intelligence of systematic and systemic aspects of organisational change: there is a tendency for significant challenges (such as education for sustainability) to be understood and accommodated within the norms of the existing system, /10/ rather than change it according the challenge (Sterling, 2009). Education as a whole, and environmental and sustainability education in particular, are limited in their ability to make a positive difference to assure a sustainable future (Sterling, 2003). Whilst environmental education in schools help to normalise environmental values, children will take cues for appropriate behaviour from the media, peer group and society as a whole (Bedford, 2002). Education is both a great hope and a great danger: it can develop questioning, innovation and creativity, enable to recognize the powerful forces that drive unsustainable living and develop self-confidence and organizational skills, but it can also play the opposite role, deadening curiosity and innovation; encouraging acceptance of unsustainable living as being normal; and to passively wait for others to take action (UNECE, 2013). Education does not prosper in a context of social fragmentation and weakening social bonds: creation of choices, generation of capacities, development of motivations depend on cultural, social,



political and economical aspects; the quality of institutions and incentive structures are more critical than the quality of individual motives and morals (Krol, 2005). Preparing people to assume their positions in society, both as professionals and citizens, cannot be reduced to ritualistic actions, such as voting or paying taxes, nor can it encourage an uncritical ideological allegiance to the "free-market", transforming schools in training centers for compliant egocentric producers and consumers, instead of centers of critical inquiry and institutional change. In the ecosystemic approach, instead of trying to adapt to droughts, floods, air pollution, land degradation, deforestation and rising sea levels, that inevitably will lead to overall catastrophe, it is posited that we should deal with the present paradigms of growth, power, wealth, work and freedom embedded into the cultural, social, political and economical institutions. Creation of choices, generation of capacities, development of motivations depend on the configurations formed by the assembly of four dimensions of being-in-the-world (Pilon, 2010), *intimate*, *interactive*, *social* and *biophysical*, as they combine to induce the events (deficits/assets), cope with consequences (desired/undesired) and contribute for changes (potential outputs). The equilibrium (table I) or disruption (table II) between the different dimensions are linked to opposite models of culture (ecosystemic or non-ecosystemic);

*Table I*

**Dimensions' equilibrium in the ecosystemic model of culture**

	Donors			
recipients	<i>intimate</i>	<i>interactive</i>	<i>social</i>	<i>biophysical</i>
<i>intimate</i>	creativity	support	services:	vitality
interactive	altruism	teamwork	alliances	niches
social	citizenship	partnerships	organisation	spaces
biophysical	care	defence	sustainability	equilibrium

*Table II*

**Dimensions' disruption in the non-ecosystemic model of culture**

	Inflictors			
<i>victims</i>	<i>intimate</i>	<i>interactive</i>	<i>social</i>	<i>biophysical</i>
<i>intimate</i>	solipsism	subjection	neglect	harm
interactive	egotism	fanaticism	co-opting	dispersal
social	abuse	corporatism	tyranny	extinction
biophysical	injury	damage	spoliation	savageness

Table III

**Intertwining the four dimensions of the world in the diagnosis and treatment of the problems**

Stages of Proces	INTIMATE	INTERACTIVE	SOCIAL	BIOPHYSICAL
Diagnosing the Events	People's Cognitive and Affective Deficits and Assets Existential Control	Dynamics of Primary Groups Communities' Organisation	Cultural Aspects Social Structure Public Policies Services	Conditions of Natural and Built Environments Beings and Things
Eliciting Favourable Changes	Promoting Peoples' Educational and Cultural Development	Improving Relationships Social Networks Community Building	Public Policies Law Enactment Social Control Civic Action	Quality of Natural and Man-Made Environments Beings and Things
Evaluating the Process of Change	Well-Being Awareness Resilience Creativity	Proactive Groups Community Solidarity Cohesion	Social Movements Well-Fare Policies Social Trust Citizenship	Equilibrium Between Natural and Man-Made Environments

the process of change encompasses a synchronized work with the four dimensions of being-in-the-world, /11/ considered altogether in view of an integrated approach to public policies, research and teaching programmes (table III). Relationships with fellow beings encompass the concepts of group and grid: the former refers to the clarity of the boundaries around a group to which people belong; the latter to the strength of the rules which govern how people relate to one another: hierarchical societies with strong ties score highly on group and grid; individualist or market-driven ones are weak on both (Douglas, 1996). The *United Nations Decade for Education for Sustainable Development* emphasized critical thinking and problem solving, interdisciplinary and holistic multi-method, values-driven approaches, environmental principles, /12/ social awareness, ethical dimensions, economic prudence, confidence and participatory decision-making (Lindberg, 2005). To create awareness and capabilities beyond schemes of thought, feeling and action, subjective and objective realities should be entangled, creating an “excess of meaning” (Gadamer, 1977), encompassing the alien that we strive to understand and the familiar that we take for granted (fig. 3), which implies a process of socialisation, externalisation, combination

and internalisation (Nonaka and Konno, 1998). “Semiotic niches” are embedded in the same “semiosphere”, representations of external reality (“mental models”), filter information and store it, as complex and dynamic systems to reason and make decisions, consolidating behaviours (Jones, 2011). Arguing about values is useless, but realizing the significant role values play in judgments lead to more constructive discussions and decision-making (Ackoff, 2010). In the socio-cultural learning niches, /13/ the individual and collective projects of life are unveiled and dealt with by heuristic-hermeneutic experiences; intermediary objects (curious things, images depicting everyday life), are presented to the participants to generate awareness, interpretation and understanding beyond established stereotypes. The contributions of the participants (table IV) are analysed from a thematic (“what”), an epistemic (“how”) and a pragmatic (“whom, when, where”) point of view, encompassing the emphasis and inclusiveness of contents in the different dimensions (“thematic”), /14/ the structure of thought embedded into subject-object relationships (“epistemic”) /15/ and the actions, strategies and foreseen consequences embedded in the outputs (pragmatic). The methodology is experiential and reflexive, “reality” is revealed in a specific space-time horizon of understanding, feeling and action: subject-object relationships are unveiled (intimate dimension), statements are shared (interactive dimension), setting the ground to examine different forms for being-in-the-world (social and biophysical dimensions).

*Table IV*

**Statements collected in two socio-cultural learning niches in a collaborative design setting**

**Group A**

1. Half shell; organic/inorganic; nature/human made; solid/flexible.
2. Found objects; shell/stones; artefacts; a collection of diverse objects not belonging to any category.
3. Objects of nature are more beautiful and interesting in form than are manufactured articles - but the metal caps may suggest that nature provides in many ways - even when unaesthetic.
4. Sharp and smooth texture; manipulate.
5. Contents: world, rocks from ocean, trash caps, city from modern society, black stones, forest plant; the contents represent global communities: rural, urban, forest, islands.
6. Three black seeds, three elastically connected bottle caps, three white river stones and a heart shaped, dried, open seed pot lay in a white rectangular open top plastic

container; remains of living plants, time worn rocks and man-made metal objects represent earth materials.

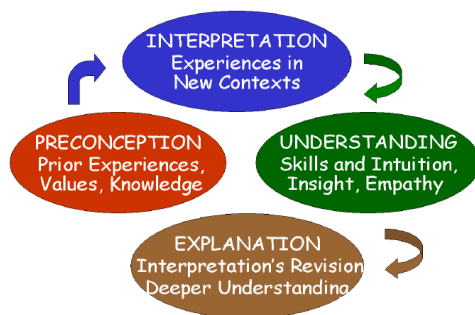
7. Different shapes, sharp objects, smooth, multi-national corporations, dry.
8. Natural food and junk food; moderation - nature's way and mass consumption; voluntary simplicity, consumerism. sustainability, extinction/destruction.
9. I wonder what type of music these items make; was/is the heart-shaped thing good to eat; what are the little "black beans", how were the holes drilled in the pop tops? What kind of soda are the two unfamiliar?

### Group B

1. Box having within: three bottle caps tied up by an elastic string (it may suggest interaction, integration, inter-personal communication, horizontality); a seashell, three pink stones (it may suggest compartment, non integration between parts); a ribbon of paper with the inscription: how many parts have a grain? (it may suggest the type of information discussed interaction).
2. This box (and maybe others) remembers me of my childhood and a beloved aunt, who kept photos and others belongings in it. I feel the smell of sea in the stones and in the alga. I don't know how many parts there in a seed, but nevertheless it would contain the production of life. The link between the objects means the link with other people and the basis of social relations. "Keeping" in the box means to keep people, to keep carefulness, preserving relations that became intense.
3. The box deceived me, I expected much for so little. I thought it cold, it is not; heavy, but no. I don't like it, it is smooth, opening it I thought of a jewel-case; new sensations: white little stones, similar to those in the river where I work; united bottle caps, but for children.
4. Curiosity, boredom, impatience, beach, sea, chilled water, patience, questions and answers, sand, anxiety, to solve, "Maria Chiquinha", children songs, China, Japan, grains, quantity, immensity, plenitude, rest, tiredness.
5. Feeling of anguish in view of the time; inside each of us there are simple and complex things; their development will help us to grow as people.

It is a situation elicited by altered details that cannot be fixed, a deviation from supporting standards, where an object or event is experienced in an unsettling, uncanny condition, presenting and manifesting itself at the edge of something else in the situational and performative context, unveiling expectations in the four dimensions of being in the world and leading to an out-of-the-box contact with other subjects and objects. In the socio-cultural learning niches, participants experience each other, creating space to human connections, generative dialogues and curiosity, in a state of

resonance, in which transformation is an outcome of the attunement and the on-going reflections. The objective is not to solve taken for granted problems, but to unveil and work with the dynamic and complex configurations that originate them; instead of being trapped into the path-dependency of pre-established problem-definitions, /16/ the heuristic-hermeneutic work /17/ develops a capacity to ask wider questions, reframing the problems in the process.



**Fig. 3. Heuristic-hermeneutics processes in the socio-cultural learning niches**

The process implies many changes, transformations, reconsiderations, revisions, and significant expansions in concepts and ideas; as a process of exploration, inquiry, and discovery – rather than a recording or a re-presentation of an already established and finalized position – it builds the ground to create new paradigms for being-in-the-world. Beyond generating new knowledge, contended values, social, cultural and economic constraints are faced, enabling people in the socio-cultural learning niches to develop new action pathways, to explore new scenarios and information relevant to achieve outcomes, “blurring the boundaries between academic disciplines, research, policy, and practice, and between states, markets, and society” (Leith, et al., 2017).

“Environmental” and “development” education needs the construction of a “new story for mankind”, enhancing human rights and justice, local and global citizenship, supporting the efforts to understand and transform the social, cultural, political and economic structures affecting life at personal, community, national and international levels (Irish Aid, 2007). In view of epistemological and ontological dimensions for knowledge creation (Nonaka, 1994), teaching for meaning (fig. 3), in a cultural context that values only information transmission, is one of the main challenges to salvage the realm of character and moral development; the present ethos should not center on individual good and individual value alone, but on the environment and the public space, /18/ as a global system (Boostrom, 1997). Education for citizenship is not reduced to formal or ritualistic actions, as voting or paying taxes, nor can it be an uncritical

ideological allegiance to the "free-market", transforming schooling in training centers for a compliant work force, which takes for granted the life style of "egocentric producers and consumers" (Chermayeff and Tzonis, 1971).

Collective practices, according to evolutionary theories of change, may be selected by the social environment rather than by individual dispositions; cultural evolution is linked to the role played by human intervention, which entails intelligence, purpose, calculation, planning, learning, arguing, persuading, discussion, and argument (Nelson, 2005). Despite the number of institutions addressing environmental degradation and sustainable development, environmental problems have been exacerbated rather than solved; international environmental governance lacks co-ordination and is at odds with other areas of global governance, notably economic and development governance (United Nations University, 2010).

The industrial culture divides the person into parts and the world into fragments; environment is one whole, it is not cut up into specialties, disciplines and departments (Drengson, 1995), it requires boundary-crossing skills, abilities to change perspective, to cope with complexity and to synthesize different disciplines or areas of expertise in a critical and creative way (Fortuin et al., 2008). Education and mass media are affected by vested interests, intolerance and violence; news media institutions, due to political economic pressures, are bound to the dominant paradigm and its key actors. To bridge the gap between human design and the ecologically sustainable systems of nature (UNESCO-EOLSS, 2008), we need to redesign technologies and social institutions to counteract the current paradigms. /19/ Environmental awareness is not simply awareness of the natural environment but also of social, economic and cultural dimensions; it requires 'dynamic' skills to discover and study the environment and find solutions, a capacity to discern the relevant dimensions of a situation, responsibility, initiative taking, independence, commitment (Hugonnier, 2008). It means producing more of the things that people need —food, shelter, clothing, education, security, health care — and not the costly things they do not —military hardware, pollution, traffic jams, useless chattels and crime. /20/ Failures in governance at many levels, and the resulting suspicion and mistrust, clearly also play a role in the current state of affairs. /21/

Rational decision-making based on "facts" is no longer defensible; emotions, values and ethics play a much stronger role than mere information, education requires a knowledgeable and congruent teaching and learning ground, a core element for comprehension, preparedness and action, abilities to participate in, influence, share and control the learning process (Tilbury et al., 2005). People with different values draw different inferences from the same evidence (Kahan et al., 2012); development, and utilization of concepts, tools and

practices must take into account the collective forms of being-in-the-world; citizen-consumer's potential to alter natural consuming habits, to 'shop ethically, 'care for the environment' and 'think globally' depends on social motivation rather than rational choice (Klintman, 2012).

Culture define the knowledge of the past and the expectations for the future: it shapes individual and collective identities, affect the impact of innovations and social change, construct the social meanings of technologies, create new boundaries, new forms of social exclusion and marginality, frame experience of space and place in everyday life and individual and collective identities (*Sociology of Culture Conference*, 2010). Beyond the objectivistic description of facts or dissemination of information, acceptance of ethical norms, peace building, environmental equilibrium requires a host of ethically interpreted and ordered social experiences, a capacity to develop morally relevant interests as the bases of rights-bearing, a broad, universally cultural knowledge (Znaniecki, 1935).

Trans-disciplinarity does not only combine views or merge ideas, but questions the “givens”, it forces the “detachment” from ones’ familiar discipline, culture, and belief; it is not a denial of initial identities, nor complete attachment to the alternative, but “a new awareness, a distance from the world before any type of analysis” (Takashi, 2010). What are the prospects of education as a whole, and environmental and sustainability education in particular, regarding the severe threats faced by today’s world? Identifying complex configurations that predict particular outcomes asks for an analysis of assumptions, contentions, consensus and conflicts, which are essential to the definition of the problems and to build new paradigms to live better in a better world. /22/

“Education for sustainability” includes international development, economic development, cultural diversity, social and environmental equity, human health and wellbeing. In order to deal with sustainable development in both environmental and cultural terms we need a theory of cultural sustainability, since the concept of sustainability implies a holistic approach to modelling economic, biological and cultural processes (Throsby, 2008). Media should draw attention to “environmentalism and culture as significant and important in symbolic and visual terms, in view of different incentives for positive action and institutional support to ensure legitimacy and continuity in the process” (Hannigan, 1995). Well-being is not simply an individual attribute, but a social relational phenomena. /23/

University teaching is vital in maintaining a social conscience based on self-awareness and self-transformation, for preparing people to assume key positions in society, both as professionals and citizens; the discussion of current problems should transcend traditional disciplines and national boundaries, in the

light of global perspectives, international cooperation, transdisciplinary research and teaching programmes. The development and evaluation of teaching programmes, research projects and public policies should contribute for the transition from a non-ecosystemic to an ecosystemic model of culture, taking into account the configurations formed by the ensemble of the four dimensions of being in the world in the origin and denouement of the events, in terms of a forecasting framework (fig. 4).

	INTIMATE	INTERACTIVE	SOCIAL	BIOPHYSICAL
DIAGNOSIS OF THE EVENTS	SUBJECTS' COGNITIVE AND AFFECTIVE ACTUAL STATUS	GROUPS ' AND COMMUNITIES' DYNAMICS AND COHESION	PUBLIC POLICIES LAW ENACTMENT CITIZENSHIP PARTICIPATION	NATURAL AND MAN-MADE ENVIRONMENTS BEINGS, THINGS
ELICITING NEW EVENTS	DEVELOPMENT OF SUBJECTS' EXISTENTIAL SELF-CONTROL	DEVELOPMENT OF GROUPS AND PRO-ACTIVE COMMUNITIES	DEVELOPMENT OF PUBLIC POLICIES AND CITIZENSHIP	PROMOTION OF NATURAL AND MAN-MADE ENVIRONMENTS
IMPACT ON EACH DIMENSION	ENHANCEMENT OF SUBJECTS' WELL-BEING	ENHANCEMENT OF GROUPS AND COMMUNITIES	ENHANCEMENT OF POLICIES AND CITIZENSHIP	ENHANCEMENT OF OVERALL ENVIRONMENT

**Fig. 4. The process of change implies a synchronized work with the four dimensions.**

The process of change must be associated with an ecosystemic model of culture, to “eco-centric policies” versus “mass production policies” (Gorobets, 2014), leading to public action to transform development policies and structures that wipe out biodiversity, destroy natural and built environments, abuse landscapes and resources, demolish living-spaces and generate unmanageable refuses that menace the future of life on Earth. /24/ As politicians and experts engage on uncertain technocratic arguments, the world continues to be shaped by inequality and injustice, deeply ingrained in our chaotic global political and economic life (Kennedy, 2016); operating under the rubric of "the global economy", international oligarchs, looking out only for their interests, have no fixed return addresses and continue immune to our control. /25 /Privileged elites will not voluntarily relinquish their exalted status, nor remove their hand from the levers of power; they “essentially capture regulatory agencies that should operate in the public interest, engineering the laws that legitimize their corrupt actions and reinforce their control” (Rees, 2011).

A concerted action by public and private sectors, social organisations, scientific and technical institutions, requires that the various parties cease to defend their vested interests in benefit of a real change in the current world system; to bring about new ways tounderstand things and create a critical capacity to operate change, new paradigms of



growth, wealth, work, power and freedom (O' Sullivan, 1987) should be embedded into the educational, cultural, economic and political institutions.

### 3. CONCLUSIONS AND RECOMMENDATIONS

As by-products of the prevailing models of culture (ecosystemic or non-ecosystemic), ethics, education, culture, natural and man-made environments, physical, social and mental well-being should be supported by societal structures and integrated in an overall context of quality of life (not treated as separate “projects”, objects of segmented programmes). Instead of taking current prospects for granted and project them into the future (exploratory forecast), the definition of desirable goals and the exploration of new paths to reach them should be pursued in view of socio-ecological objectives, a set of values, norms and policies that prioritizes human well-being, natural and built environments and the aesthetic, ethical and cultural meaning of the existence (normative forecast, “backcasting”) /26/ Although causes in the past and constraints in the present can explain the present state of the world, historic and structural forces are refracted through and activated by expectations about imagined futures (the anticipation of what lies ahead). Public policies, teaching and research programmes, nowadays segmented in different domains, should consider the role of the different dimensions of being-in-the-world, in view of their dynamic configurations, strengthening their connections and sealing their ruptures. The demons that haunt our condition will not disappear while they are embedded in the same building blocks of our society; considering that «change is the only permanence, and uncertainty the only certainty» (Bauman, 2000), current prospects should not be taken for granted and there is sufficient reason in persisting to focus in the definition of the desirable goals and in the exploration of new paths to reach them.

In this sense, advocacy, public policies, research and teaching programmes should:

- define the problems in the core of the “boiling pot” in view of a holistic, ecosystemic framework, instead of reducing them to the bubbles of the surface (effects, fragmented, taken for granted issues);
- combine the four dimensions of being in the world (intimate, interactive, social and biophysical) in the diagnosis and prognosis of the events, assessing their deficits and assets, as donors and recipients;
- promote the singularity of (identity, proper characteristics) and the reciprocity (mutual support) between all dimensions, in view of their complementarity and dynamic equilibrium;

- prepare the transition to an ecosystemic model of culture to deal with the problems of difficult settlement or solution in the world, a condition for consistency, effectiveness and endurance.

Could wise and impartial regulators, transnational governance systems, implement the right set of norms and policies to safeguard humanity's natural and built environments, cultural inheritance, aesthetic and life-enhancing values (relational and ontological), carrying meaning and purpose to the individual and collective projects of life?

### **References 1.**

1. According to the Reflection Group on the 2030 Agenda for Sustainable Development, the sustainable development goals are being used not as a roadmap for social, economic and environmental transformation, but as a vehicle to entrench inequitable power relations: wealthy elites and rich multinational corporations translate their economic power into political access and influence government decisions.
2. Our resources are being rapidly transformed into useless garbage, some of which is obvious to the naked eye, but most of which escapes awareness. The smaller portion can be seen in garbage dumps and other visible waste. By far the larger portion can be thought of as "molecular garbage" - consisting of the vast quantities of tiny particles that are daily spewed out into the earth's air, water and soil (Robèrt, K.H. (1991).)
3. The current global corporate economy subordinates environmental standards to what are presented as "requisites" for "free" global trade and proprietary "rights" by the World Trade Organization (Sassen, 2010); multi-actor, multi-level and multi-sector structures interfere with state steering and governmental practices throughout the world. Mainstream environmentalism is dangerously obsessed with getting people to 'save the planet' while doing other things - shopping, looking cool, or just mindlessly getting on with with life (Crompton, 2013).
4. According to Girardet (2015), we need to start thinking of regenerative rather than just sustainable development; instead of "anthropocene", the next era in human history should be named "symbiocene", from the Greek symbiosis, or companionship (Albrecht, 2016).
5. Environmental culture boldly unmasks the institutional and systemic violence of our culture and reveals how our culture's life-destroying practices and ethical and spiritual bankruptcy are closely linked to our failure to situate ourselves as ecological beings (Plumwood, 2002). Heinzerling & Ackerman (2004), criticize the use of cost-benefit analysis in setting environmental policy, on the ground that there is a profound mismatch between ethical values and economic valuation. Teaching ethics do not thrive in highly corrupt societies.
6. Poor quality of life, urban violence, urbanization processes governed by real estate interests, concentration of jobs in distant areas, are inextricably intertwined. Nothing

more visibly reveals the overall decay of the modern city than the ubiquitous filth and garbage in its streets, the noise and massive congestion that fills its thoroughfares, the apathy of its population toward civic issues and the ghastly indifference of the individual toward the physical violence (Bookchin, 1979).

7. Who decides what is information and what is lobbying for money? Promoters of multi-billion dollar development megaprojects systematically misinform parliaments, the public and the media in order to get them approved and built; they often avoid and violate established practices of good governance, transparency and participation in political and administrative decision making (Flyvbjerg, B., Bruzelius, N. and Rothengatter, W., 2003).
8. "Solastalgia" is a neologism describing a form of psychic or existential distress caused by environmental change (Albrecht, 2012).
9. "The devolution of responsibility for sustainability to citizens, in their roles as consumers on the free market, has failed to produce significant change; even those most committed to sustainable living confront structural barriers that they do not have the power to overcome" (Isenhour, 2010). People no longer learned their cultural identity from their family, schools, churches and communities but instead from "a handful of conglomerates who have something to sell" (Gerbner, 2001).
10. Monetizing nature, marketization of environmental "goods", tends to undervalue non-quantitative social, aesthetic, and ethical aspects of the natural world (Unmüßig, 2014). Data revolution is too technocratic and if we don't address power dynamics behind this 'revolution' it will not be transformational (Frecheville, 2014).
11. "Being-in-the-world" encompasses four modes of existence (Binswanger, 1963): man's relationship with himself (*Eigenwelt*); man's relationship with his fellow beings (*Mitwelt*); man's relationship with overall society (*Menschenwelt*); man's relationship with his environment (*Umwelt*). Interaction requires that actors be aware of each other's actions, and that they adjust their own behaviour (and possibly their own goals), taking the behaviour of the others into account (Hanneman, and Riddle (2005).
12. Criteria to evaluate risks (precautionary principle): probability of occurrence, extent of damage, incertitude, ubiquity, persistency, reversibility, delay effect, potential of mobilization. (Klinke & Renn, 2001)
13. To understand how people create and experience their lives (Watson & Till, 2009), it is necessary to unveil the epistemic cultures which structure *how we know what we know* about the environment (Knorr Cetina, 1999). Niches are new structures, protective spaces for "pathbreaking innovations", having three functions in the wider transition processes: "shielding, nurturing and empowering" (Smith and Raven, 2012): a small core of agents
14. emerges within the system as the incumbent for innovation and emergent structures stimulate further niches' development and niche-regimes (Frantzeskaki and Loorbach, 2009).
15. Learning new forms to be in the world, as a systemic, emergent, contingent and path-dependent process, implies the co-creation and generation of new knowledge to shift the systems: 1) *intimate dimension* (knowledge, values, feelings, beliefs,

- commitments); 2) *interactive dimension* (allegiances, solidarity, partnerships, leadership); 3) *social dimension* (political, economic, social and cultural aspects); 4) *biophysical dimension* (vital needs, natural and built environment, territories, artefacts).
- 16.1) *Appropriation*: construction of new subject-object relationships, cognitive, affective and conative; 2) *Common-sense*: conformity to stereotypes and established word views, without questioning; 3) *Dogmatism*: reduction to scholarlike, logical categories, classifying and describing; 4) *Dependency*: reliance on authority to qualify own experience, alienation; 5) *Resistance*: refusal to being involved, failure to see any meaning.
  17. Beyond the anthropogenic views, that do not distinguish between the whole of the human beings and the destructive action on nature of the political-economic establishment (governments and business corporations), we should consider the power asymmetries, that confer to a small and privileged part of the world population the decisions about the destiny of the entire mankind.
  18. *Intimate Dimension*: subject-object relationships are unveiled by images or objects selected to catch the eye (bottle caps linked by a string, etc.); participants register their perceptions in a non-identified piece of paper; 2) *Interactive Dimension*: statements are distributed out of sort, read aloud, shared, and enriched; *Social and Biophysical Dimensions*: present and future forms of being in the world are analysed in view of ecosystemic and non-ecosystemic models of culture, encompassing the natural and man-made environments, the relationships between ecosystems, beings and things. Analysis explains how the pieces of the system work, synthesis raises the comprehension of the interactions between its parts (Kull 1998).
  19. Global governance can only be legitimized from ethical principles, in which the character of people and organizations constitutes the fundamental element for the changes, not just by the development of capabilities, knowledge and skills (Paehlke, 2004).
  20. Consumerism as concept can not be attacked using ethical formulations and can not be understood outside of the socio-technical systems (Holt, 2012); economic groups that support “development” strategies are the same worldwide: banks, agribusiness, contractors, mining companies; in the teeming cities of today buildings tower to the sky while problems are getting worse: environmental catastrophes, criminality, corruption, vested interests: “sustainable development have become part of the so-called problem-industrial complex: societal regimes that are dependent on sustaining ‘problems’ such as waste production, sickness, fossil energy and so on” (Loorbach, 2014)..
  21. We should not persist in speaking about development within the current political-economic frame of reference, but persist in speaking about changing the current political-economic frame of reference; Gehl (1996) distinguishes between necessary/functional activities, which take place regardless of the quality of the physical environment, and optional/recreational activities and social activities, which depend to a significant degree on what public places have to offer and how they make people behave and feel about them; different values are at play

22. especially cooperation not competition, and frugality and self-sufficiency, not acquisitiveness and consuming (Trainer, 2010).
23. Monetising or valuing nature turns it into a commodity, the economic invisibility of resource depletion and pollution leads to systemic failures in all public spheres of decision, green innovations and new practices (in behaviour and policy) face an uphill battle, played out on economic, technical, political, scientific, and cultural dimensions: transport, energy, agri-food systems, stabilized by vested interests and favourable institutions lead to path dependence and entrapment: (Sustainability Transitions Research Network (2010).
24. Policy makers and researchers – disregarding the profound epistemological and ontological issues at stake – have adopted structuralist approaches, with their stress on institutions and institution building, failing to account for the design, formation and maintenance of institutions, encompassing the role of leaders, elites and coalitions and the general patterns of institutional failure or corruption (Leftwich, 2010).
25. It would take only three to five percent of elites at the top of influence (military, economic, political, educational and cultural: media, arts, entertainment) to shift the mindset of the larger population (Collins and Makowsky, 2009). Due to the process and resulting outcomes of the ascendance of business interests, values and models in public policies, research and teaching programmes (“corporatization”), the mediaeval custom of selling ‘indulgences’ is retrieved today by paying money to make up for ‘green sins’, for ‘climate compensation’ (instead of eliminating social malpractice from production and supply chains).
26. Atkinson (2015), combines agent-based modelling (capable of capturing heterogeneous attributes, behaviours, and interactions of individuals) and system dynamics modelling (which captures population-level, ecological influences, and whole system dynamics). To moral and democratic education (Lind, 2003), more important than the need for a radically different economy, is to change current values, notably the present commitments to competition, individualism and acquisitiveness, and the conception of progress (Trainer, 2001). Market induced policies conceive fashion stylists as relevant as Shakespeare, a footballer, a value equal to Michelangelo, a rapper, not less than Stravinsky; this cultural relativism is the result of a demagogic, pseudo democratizing cultural policy, which does nothing more than to dissolve culture in a “everything is culture”; in the absence of the State, culture is reduced to a mere commodity (Finkelkraut, 1987).
27. “Civil society with its networks of voluntary and community organisations is a far more palatable partner for neoliberalising states than the unions; it can be incorporated into state projects, and provide links into dispossessed and alienated communities that are abandoning the institutions of representative democracy” (Davies, 2016); the neoclassical monopoly at university departments of economics with its ideological features is not compatible with normal ideas about democracy (Söderbaum, 2016).
28. “Backcasting” is a planning method that starts with defining a desirable future and then works backwards to identify policies and programs that will connect that

specified future to the present: "projects" are engineering challenges that can be controlled and managed as schemes to be applied and monitored via indicators and checklists, rather than as innovations to be questioned; evaluative thinking involves thinking about the ways we reason, plan and act, it is a way of viewing the world, an ongoing process of critical reflection on, and appraisal of, assumptions and claims" (Schwandt et al., 2016).

## References 2.

1. Ackoff, R. L. Differences That Make a Difference: An annotated glossary of distinctions important in management. Triarchy Press, Axminster, 2010.
2. Albrecht, G.A., The Age of Solastalgia. August 7, 2012 [on line]: <https://theconversation.com/the-age-of-solastalgia-8337>
3. Albrecht, G.A., Exiting the Anthropocene and Entering the Symbiocene, *Minding Nature*, 2 (9): 2016. <http://www.humansandnature.org/exiting-the-anthropocene-and-entering-the-symbiocene>
4. American Anthropological Association, Bringing the Past into the Present, 104th Annual Meeting, Washington, 2005.
5. Ashley, P. A. and Crowther, D. Territories of Social Responsibility. Opening the Research and Policy Agenda, Gower Publ., Surrey, 2012.
6. Atkinson, J-A et al., A modelling tool for policy analysis to support the design of efficient and effective policy responses for complex public health problems, *Implementation Science*, 2015, 10: 26 [on line]: <http://www.implementationscience.com/content/10/1/26>
7. Baiocchi, G. The Citizens of Porto Alegre. *Boston Review*, March/April 2005. [online]: <http://bostonreview.net/BR31.2/baiocchi.html>
8. Bauman, Z. *Liquid Modernity*, Cambridge: Polity, 2000.
9. Beck, U. *Cosmopolitan Vision*, Polity Press, Cambridge, 2007.
10. Bedford, T. Parliament Committee on Environmental Audit.
11. United Kingdom, 2002. [online]: <http://www.publications.parliament.uk/pa/cm200203/cmselect/cmenvaud/472/3022702.htm>
12. Binswanger, L. *Being-in-the-World: Selected Papers of Ludwig Binswanger*. Condor Books, London, 1963.
13. Bookchin, M. *The Ecology of Freedom*. Knopf, New York, 1982.
14. Bookchin, M. *Limits of the City*, Black Rose Books, Montreal, 1996.
15. Boostrom, R. Teaching by the Numbers, in Burbules, N. C. and Hansen, D. T. *Teaching and its Predicaments*. Westview Press, Boulder, 1997: 45-64.
16. Bown, L. What do we Mean by Development? Development Education Centre [Birmingham] and Educating and Acting for a Better World [Ireland], 2007 [online]: <http://www.developmenteducation.ie/files/resources/What.pdf>
17. Brown, P. G. and Garver, G., *Right Relationship: Building a Whole Earth Economy*, Berrett-Koehler Publishers, San Francisco, 2009.

18. Buell, F. *From Apocalypse to Way of Life: Environmental Crisis in the American Century*; Routledge, 2003.
19. Chermayeff, S. & Tzonis, A. *Shape of Community, Realization of Human Potential*. Middlesex, Penguin Books, 1971.
20. Coleman, J. *The Asymmetric Society*, New York, Syracuse University Press, 1985.
21. Collins, R. and Makowsky, M. *The Discovery of Society*, McGraw-Hill, New York, 2009.
22. Crompton, T., SLRG/CES Seminar, University of Surrey, WWF-UK. 2013 [on line]: <http://www.sustainablelifestyles.ac.uk/event/green-consumerism>
23. Davies, J. S., Why network governance won't stop climate change, INOGOV/Tyndall Centre for Climate Change Research [online]: <http://www.inogov.eu/blog-why-network-governance-wont-stop-climate-change/>
24. Dietz, T., *The Art of Influence*, Nature, 479, 176: 2011
25. Douglas, M. *Natural symbols: explorations in cosmology*, Routledge, New York, 1996
26. Drengson, A. *The Practice of Technology: Exploring Technology, Ecophilosophy, and Spiritual Disciplines for Vital Links*. Suny, Albany, 1995.
27. Elohim, J. L. *The Performance of the World System. A Critical Viewpoint in Parra-Luna, F. The Performance of Social Systems: Perspectives and Problems*. New York, Kluwer Academic/Plenum Publishers, 2000.
28. Etzioni, A., *Toward a New Socio-Economic Paradigm*, Socio-Economic Review, 1, (1) 105-118: 2003. Available at SSRN: <http://ssrn.com/abstract=2157130>
29. Ewald, F. *Le retour du malin genie. Éskisse d'une philosophie de la précaution*. In Godard, O. and Long, M. *Le principe de précaution dans la conduite des affaires humaines*. Association NSS-Dialogues. Editions Quae, 1997.
30. Finkelkraut, A., *La défaite de la pensée*, Paris, Gallimard, 1987.
31. Fortuin, K. P. J. et al. *The European Workshop: a course aimed at educating students to cross boundaries*. Engineering Education in Sustainable Development (EESD) Conference, Graz, 2008 [online]: [http://www.esa.wur.nl/NR/rdonlyres/B2FA6130-462D-43BF-8D67-B797439AA538/70366/030908\\_paper\\_Fortuin\\_Bush\\_Henriksen.pdf](http://www.esa.wur.nl/NR/rdonlyres/B2FA6130-462D-43BF-8D67-B797439AA538/70366/030908_paper_Fortuin_Bush_Henriksen.pdf)
32. Foster, J. B. and Clark, B. *The Planetary Emergency*, Monthly Review, 07 (64), 2012 [on line]: <http://monthlyreview.org/2012/12/01/the-planetary-emergency>
33. Flyvbjerg, B. et al. *Megaprojects and Risk: An Anatomy of Ambition*, Cambridge Univ. Press, 2003.
34. Frantzeskaki, N. and Loorbach, D. *A transition research perspective on governance for sustainability*, In: *European Research on Sustainable Development*, 2009. [online]: [https://www.researchgate.net/publication/226482740\\_A\\_Transition\\_Research\\_Perspective\\_on\\_Governance\\_for\\_Sustainability](https://www.researchgate.net/publication/226482740_A_Transition_Research_Perspective_on_Governance_for_Sustainability)
35. Frecheville, N., *What's missing from the data revolution? People*, 2015 [posted on line]: <http://post2015.org/2014/02/06/whats-missing-from-the-data-revolution-people/>

36. Gadamer, H. G. *Philosophical hermeneutics*. University of California Press, Berkeley, 1977.
37. Gehl, J. and Gemzøe, L. *Public Spaces and Public Life*, Danish Architectural Press, Copenhagen, 1996.
38. Gerbner, G., *The Cultural Arms of the Corporate Establishment: Reflections on the Work of Herb Schiller*, *Journal of Broadcasting & Electronic Media*, 1 (45): 186 – 190: 2001.
39. Giddens, A. *The Global Third Way Debate*: Polity Press, Cambridge, 2001.
40. Girardet, H., *Creating Regenerative Cities*, Routledge, Abingdon, Oxon: 2015.
41. Gorobets, A., *Eco-Centric Policy for Sustainable Development*, *Journal of Cleaner Production*, (64) 1, 2014: 654-655.
42. Hanneman, R. A. and Riddle, M. *Introduction to Social Network Methods*. University of California, Riverside, 2005. [online]: <http://www.faculty.ucr.edu/~hanneman/nettext/>
43. Hannigan, J. A. *Environmental sociology, a social constructionist perspective*. Routledge, London, New York, 1995.
44. Harvey, D. *A Brief History of Neoliberalism*. Oxford University Press, 2005.
45. Harvey, D. *Spaces of Global Capitalism: Towards a Theory of Uneven Geographical Development*. Verso, 2006.
46. Held, D. *Global Covenant: The Social Democratic Alternative to the Washington Consensus*. Cambridge: Polity, 2004.
47. Holt, D. B., *Constructing Sustainable Consumption. From Ethical Values to the Cultural Transformation of Unsustainable Markets*, *The ANNALS of the American Academy of Political and Social Science*, 3, 2012 [on line]: <http://ann.sagepub.com/content/644/1/236>
48. Hugonnier, B. *Education For Sustainable Development in OECD Countries: Opportunities and Challenges*. Workshop on Education for Sustainable Education, OECD, Paris, 2008 [online]: <http://www.oecd.org/dataoecd/39/12/41308608.pdf>
49. Huppes, G. *Eco-efficiency: From focused technical tools to reflective sustainability analysis*. *Ecological Economics*, 68 (6), 2009: 1572-1574.
50. *Irish Aid Development Education: an Introduction*. Irish Foreign Office Publication, 2007 [online]: <http://www.irishaid.gov.ie/Uploads/Irish%20Aid%20and%20Development%20Education.pdf>
51. Irwin, R. 'After Neoliberalism': *Environmental Education to Education for Sustainability*, Conference Presentation, Philosophy of Education Society of Australasia, 2007 [on line]: [http://www.academia.edu/3123057/After\\_Neoliberalism\\_Environmental\\_Education\\_to\\_Education\\_for\\_Sustainability](http://www.academia.edu/3123057/After_Neoliberalism_Environmental_Education_to_Education_for_Sustainability)
52. Isenhour, C. *Building Sustainable Societies: Exploring Sustainability Policy and Practice in the Age of High Consumption*, Ph. D. Dissertation, University of Kentucky, 2010 [on line]: [http://uknowledge.uky.edu/cgi/viewcontent.cgi?article=1000&context=gradschool\\_diss](http://uknowledge.uky.edu/cgi/viewcontent.cgi?article=1000&context=gradschool_diss)



53. Jones, N. A. et al. Mental Models: An Interdisciplinary Synthesis of Theory and Methods, *Ecology and Society*, (16) 1; 46, 2011 [online]: <http://www.ecologyandsociety.org/vol16/iss1/art46/>
54. Kahan, D.M. et al. The polarizing impact of science literacy and numeracy on perceived climate change risks. *Nature Clim. Change*, 2, 732–735, 2012.
55. Kasser, T., & Ryan, R. M. Further examining the American dream: Differential correlates of intrinsic and extrinsic goals. *Personality and Social Psych. Bulletin*, 22, 280-287, 1996.
56. Klinke, A. & Renn, O. Precautionary principle and discursive strategies: classifying and managing risks, *Journal of Risk Research*, 2, (4) 2001: 159-173.
57. Klintman, M. *Citizen-Consumers and Evolution: Reducing Environmental Harm through our Social Motivation*, Palgrave Macmillan, 2012.
58. Knorr Cetina, K., *Epistemic Cultures*. Harvard University Press, 1999.
59. Krol, G.-J. *Environmental problems, morals and incentives in modern societies*. Institute of Economic Education, Univ. of Münster, 2005: <http://www.wiwi.unimuenster.de/ioeb/downloads/forschen/Krol/EnvironmentalProblems.pdf>
60. Kull, K. On Semiosis, Umwelt, and Semiosphere. *Semiotica*, 3/4 (120), 1998: 299-310 [on line]: <http://www.zbi.ee/~kalevi/jesphohp.htm>
61. Kennedy, D., *A World of Struggle: How Power, Law and Expertise Shape Global Political Economy*, Princeton Univ. Press, 2016.
62. Labonte, R. 2004. Social inclusion/exclusion: dancing the dialectic. *Health Promotion International*, 19 (1): 115-121.
63. Layzer, J. A. *The Environmental Case: Translating Values into Policy*. Sustaining Cities: Environment, Economic Development, and Empowerment Conference. MIT Dept. of Urban Studies and Planning, 2008 [on line]: <http://mitworld.mit.edu/stream/572/>
64. Lefebvre, H. *The Urban Revolution*, University of Minnesota Press, 2003
65. Leith, P. et al., *Enhancing Science Impact: Bridging Research, Policy and Practice for Sustainability*, CSIRO Publishing, Clayton, 2017.
66. Leftwich, A. Beyond Institutions: Rethinking the Role of Leaders, Elites and Coalitions in the Institutional Formation of Developmental States and Strategies, *Journal Forum for Development Studies*, 37, 2010 - Issue 1: 93-111.
67. Lind, G., The meaning and measurement of moral judgement competence revisited - A dual-aspect model. In: D. Fasko & W. Willis, Eds. *Contemporary Philosophical and Psychological Perspectives on Moral Development and Education*. Hampton Press, Cresskill, 2003.
68. Lindberg, C. *The UN Decade of Education for Sustainable Development*. UNECE High-Level Meeting of Environment and Education Ministries, Vilnius, 2005. [online]: <http://www.unece.org/env/esd/HLM.intervent/UNESCO.Carl.doc>
69. Loorbach, D., *To Transition! Governance Panarchy in the New Transformation*, 2014 [online]:
70. [http://www.drift.eur.nl/wp-content/uploads/2014/11/To\\_Transition-Loorbach-2014.pdf](http://www.drift.eur.nl/wp-content/uploads/2014/11/To_Transition-Loorbach-2014.pdf)

71. March, J. G. and Olsen, J. P. *Rediscovering institutions: the organizational of politics*, Free Press, 1989.
72. Mason, M. *The Governance of Transnational Environmental Harm: Addressing New Modes of Accountability/Responsibility*. *Global Environmental Politics* (8) 3: 8-24, 2008.
73. Massumi, B. *A User's Guide to Capitalism and Schizophrenia: Deviations from Deleuze and Guattari*. MIT Press, Cambridge, Mass. 2003.
74. Max-Neef, M. A. *Human Scale Development: Conception, Application and Reflections*, New York, Apex Press, 1991.
75. McMichael, A. J., *Globalization, Climate Change, and Human Health*, *N. Engl. J. Med.* 2013; 368: 1335-1343: [http://www.nejm.org/doi/full/10.1056/NEJMra1109341?af=R&rss=currentIssue&&utm\\_source=buffer&buffer\\_share=5e4c5&](http://www.nejm.org/doi/full/10.1056/NEJMra1109341?af=R&rss=currentIssue&&utm_source=buffer&buffer_share=5e4c5&)
76. Meisel, N. *Governance Culture and Development: A different Perspective on Corporate Governance*, OECD Development Centre Study, Paris, 2004.
77. Nelson, R. R. *Evolutionary Theories of Cultural Change: An Empirical Perspective*. Columbia University, 2005 [online]: [http://etss.net/files/Nelson\\_Cultural\\_Change.pdf](http://etss.net/files/Nelson_Cultural_Change.pdf)
78. Nonaka, I., *A dynamic theory of organizational knowledge creation*, *Organization Science*, 5 (1), 1994.
79. North, D., *Institutions, institutional change and economic performance*, Cambridge University Press, Cambridge, 1990.
81. O' Sullivan, P. E. *Environment science and environment philosophy*. *The Int'l J. of Environment Studies*, 28; 257-267, 1987.
82. Orhan, O. *Three Modes of Environmental Justice in World Politics*. The annual meeting of the American Political Science Association, Aug 27, 2003 [online]: [http://www.allacademic.com/meta/p62643\\_index.html](http://www.allacademic.com/meta/p62643_index.html)
83. Orr, D. *Earth in Mind*, Island Press, 1994.
84. Paehlke, R. C. *Democracy's Dilemma: Environment, Social Equity, and the Global Economy*, The MIT Press, Cambridge, 2004.
85. Pilon, A. F. *The Bubbles or the Boiling Pot? An Ecosystemic Approach to Culture, Environment and Quality of Life*. *Environmental Geology*, 57 (2) 2009. [online]: <http://www.springerlink.com/content/w6l306m214813077>
86. Pilon, A. F. *Living Better in a Better World: Development and Sustainability in the Ecosystemic Model of Culture*. *OIDA International Journal of Sustainable Development*, 2 (4): 25-36, 2010 [on line]: <http://ssrn.com/abstract=1713371>
87. Plumwood, V. *The Ecological Crisis of Reason*. Routledge, New York and London, 2002.
88. Rees, W. E., *Toward a Sustainable World Economy*. Institute for New Economic Thinking Annual Conference, Bretton Woods, 8-11 April, 2011 [on line]: <http://whatcom.wsu.edu/carbonmasters/documents/TowardSustainableWorldEconomy.pdf>

89. Reflection Group on the 2030 Agenda for Sustainable Development, Inequality will not be solved by private sector initiatives [on line]: <https://www.reflectiongroup.org/en/publication/inequality-will-not-be-solved-attention-grabbing-private-sector-initiatives-it-requires>
90. Richmond, B. *The “Thinking” in Systems Thinking: Seven Essential Skills*. Waltham, MA: Pegasus Com.s, 2000.
91. Robbins, P. *Political Ecology: a Critical Introduction*. Blackwell Publishing, 2004.
92. Robèrt, K.H. (1991). "Educating A Nation: The Natural Step." *In Context* 28:10.
93. Rotmans, J. and Loorbach, D. Complexity and Transition Management, *Journal of Industrial Ecology* (13) 2: 184-196, 2009.
94. Rabkin, J., A review of: *The global environment and world politics*, 2nd ed. by Elizabeth DeSombre, *The Electronic Journal of Sustainable Development* (2008) 1(2).
95. Sassen, S. Cities are at the center of our environmental future, *S.A.P.I.E.N.S.*, (2) 3, 2010, [online]: <http://sapiens.revues.org/index948.html>
96. Scheffer, M. et al., Catastrophic shifts in ecosystems. *Nature*, 413: 591-596, 2001.
97. Schwandt, T. et al., Realising the SDGs by reflecting on the way(s) we reason, plan and act: the importance of evaluative thinking. International Institute for Environment and Development, IIED Briefing, 2016 [online]: <http://pubs.iied.org/pdfs/17380IIED.pdf>
98. Shove, E., et al., *The Dynamics of Social Practice: Everyday life and how it changes*, London: Sage, 2012.
99. Smith. A. and Raven, R. What is protective space? Reconsidering niches in transitions to sustainability. *Research Policy* 41 (2012) 1025–1036 [online]: <https://grassrootsinnovations.files.wordpress.com/2012/08/smith-and-raven-2012-what-is-protective-space1.pdf>
100. Soskolne, C. L. Ethical, Social, and Legal Issues Surrounding Studies of Susceptible Populations and Individuals. *Environmental Health Perspectives*, 145 supplement 4, 1977
101. Sterling, S. *Whole Systems Thinking as a Basis for Paradigm Change in Education: Explorations in the Context of Sustainability*, University of Bath, 2003. [online]: <http://www.bath.ac.uk/cree/sterling/sterlingtitle.pdf>
102. Sterling, S. ‘Mission impossible’ - or ‘never ending story’? CREE seminar University of Bath, 2009 [on line]: <http://www.bath.ac.uk/cree/seminars/BathSterlingJuly09.ppt>
103. Sociology of Culture Conference, Culture and the Making of Worlds, Università Bocconi, 2010 [on line]: <http://www.esaculturebocconi2010.org/the-conference/the-theme.html>
104. Söderbaum, P., *Economics, ideological orientation and democracy for sustainable development*. World Economics Association Books, 2016 [online]: [www.worlddeconomicsassociation.org](http://www.worlddeconomicsassociation.org)
105. Sullivan, S. *The Natural Capital Myth*, The Public Political Ecology Lab, University of Arizona, working paper, 2013 [on line]: <http://ppel.arizona.edu/blog/2013/03/15/natural-capital-myth>
106. Sustainability Transitions Research Network, 2010 [on line]: [http://www.transitionsnetwork.org/files/STRN\\_research\\_agenda\\_20\\_August\\_2010\(2\).pdf](http://www.transitionsnetwork.org/files/STRN_research_agenda_20_August_2010(2).pdf)

107. Tilbury, D. et al. A National Review of Environmental Education and its Contribution to Sustainability in Australia. Australian Dept. of the Environment and Heritage and Research, Canberra, 2005 [online]: [http://www.aries.mq.edu.au/pdf/Volume2\\_brochure.pdf](http://www.aries.mq.edu.au/pdf/Volume2_brochure.pdf)
108. Takashi, M. Diversity, Trans-disciplinarity and Sustainability Science Education. The 2nd International Conference on Sustainability Science – ICSS, Rome, 2010 [on line]:
109. [http://icss2010.net/download/documents/24-JUNE/Sessione-5\\_Sustainability-science-education/3\\_T-Mino.pdf](http://icss2010.net/download/documents/24-JUNE/Sessione-5_Sustainability-science-education/3_T-Mino.pdf)
110. Throsby, D. Linking Cultural and Ecological Sustainability. *The International Journal of Diversity in Organisations, Communities and Nations*, (8), 1: 15-20, 2008.
111. Trainer, F.E. Where are we, where do we want to be, how do we get there? *The International Journal of Inclusive Democracy* .(6), 2, 2000 [on line]: [http://www.inclusivedemocracy.org/dn/vol6/trainer\\_where.htm](http://www.inclusivedemocracy.org/dn/vol6/trainer_where.htm)
112. Trainer, F.E. Natural Capitalism Cannot Overcome Resource Limit Minnesotans for Sustainability, 2001 [on line]: [http://www.mnforsustain.org/trainer\\_fe\\_simon\\_lovins\\_critique.htm](http://www.mnforsustain.org/trainer_fe_simon_lovins_critique.htm)
113. Trainer, F.E., *The Transition: To a Sustainable and Just World*, Envirobook, Sussex Inlet, 2010
114. Unmüßig, B., *Monetizing Nature: Taking Precaution on a Slippery Slope*, Great Transition Network, 2014 [on line]: <http://greattransition.org/publication/monetizing-nature-taking-precaution-on-a-slippery-slope>
115. Unesco Education for sustainable development: a holistic approach to envisioning change and thereby achieving transformation, *Education for Sustainable Development*, 2013 [on line]: <http://www.unesco.org/fileadmin/DAM/env/esd/8thMeetSC/ece.cep.ac.13.2013.4e.pdf>
116. Unesco-Eolss Joint Committee, *Encyclopedia of Life Support Systems*, 2008 [on line]: <http://www.eolss.net/>
117. United Nations University, *Website on Sustainable Development Governance*, 2010: [http://www.ias.unu.edu/sub\\_page.aspx?catID=155&ddlID=17](http://www.ias.unu.edu/sub_page.aspx?catID=155&ddlID=17)
118. Virilio, P. and Turner, C. *The Information Bomb*, Verso, 2005.
119. Volpato, G. L., *Ciencia: da filosofia à publicação*, Cultura Acadêmica, São Paulo, 2013.
120. Wallerstein, I. *The Modern World-System*, New York, Academic Press, 1974.
121. Watson, A., & Till, K. E., *Ethnography and Participant Observation*. In D. DeLyser, S. Herbert, S. Aitken, M. Crang, & L. McDowell (Eds.), *The SAGE Handbook of Qualitative Geography*. London; New York: SAGE, 2009.
122. White H., *Figural Realism*, John Hopkins University Press, Baltimore, 1999.
123. Whitton, H. *Teaching ethics in highly corrupt societies: Concerns and opportunities*. Anti-Corruption Resource Centre. 2009 [on line]: <http://www.cmi.no/publications/file/?3345=teaching-ethics-in-highly-corrupt-societies>
124. Wilcox, L. S. Onions and bubbles: models of the social determinants of health. *Prev Chronic Dis* 2007; 4 (4) [on line]: [http://www.cdc.gov/pcd/issues/2007/oct/07\\_0126.htm](http://www.cdc.gov/pcd/issues/2007/oct/07_0126.htm)
125. Winston, M. and Edelbach, R., *Society, Ethics, and Technology*, Wadsworth-Cengage Learning, Boston, 2014.
126. Yang, M., *Introduction*, Int.l Conference on Architecture and Cities for the 21st Century Valencia, 1998. [on line]: <http://whc.unesco.org/uploads/activities/documents/activity-489-1.pdf>
127. Znaniecki, F. *Ludzie terazniejsi a cywilizacja przyszlosci (The People of Today and the Civilization of Tomorrow)*, Ksiaznica Atlas, Lwow, Poland, 1935.

## **BASIC APPROACH FOR ANALYSIS OF EARTHQUAKE RESPONSE OF DAMS**

**Zika Smiljkovic\*, Dr. A.K. Dhawan\*\***

\* *EGIS Eau, Montpellier, France, [zikas@beotel.rs](mailto:zikas@beotel.rs)*

\*\* *Specialist, Dam Instrumentation, EGIS India, [akd847@gmail.com](mailto:akd847@gmail.com)*

The paper is intended to present the domains of application of available approaches and methods for evaluation of response of dams to earthquake vibratory loads. The priority is particularly given to dams as coupled i.e. as dam-foundation entities. Yet, focus is given to usability of outputs of limit equilibrium approach and linear-dam foundation models, both having as input the lateral forces which are product of spectral seismic coefficient and unit weight of dam body.

Comparison of these outputs with those obtained from dam-foundation models with elastic spectra inputs, is further discussed, as well. The benefits and outputs confidence of each particular approach are compared in view of their use for preliminary design phase of a new or rehabilitated dams. A number of internationally recognised publications underline preliminary design phase as appropriate to expectedly conservative outputs arising out from seismic coefficient and elastic spectra approaches.

***Key Words:*** *Standard Response Spectra, Elastic Response Spectra.*

### **Introduction**

Maximum Design Earthquake (MDE) is a ground motion for which the stability of vital dam structures should be designed for new dams or, checked up for the existing dams. This is a hazard event for which significant damage of a dam is still acceptable but without considerable failure causing loss of life and severe economic loss. The Operational Basis Earthquake (OBE) is on the other hand, usually taken as 0.5 intensity of that rated for MDE. The OBE could also be considered for design but its application is limited to secondary dam-not-integrated structures such as outlet structures, switchyard structures, irrigation outlets, associated gate structures, spillway chutes and accompanying stilling basins and such like structures. The economic reasons led the consultants to adopt these criteria for secondary dam structures. Besides the dam, the dam structures such as dam overflow spillway, intake tower, dam steel gates, gantry

cranes for tail water gates when power house is embedded within a dam, and the like, vitally affecting operation of dam, should be always subjected to verification for MDE ground motions. Throughout the internationally recognised seismic codes, three modalities are accepted when subjecting the dam structures to earthquake resistant design. They are: pseudo-static or seismic coefficient method, elastic response spectra and time history approach. The latter one, time-history, is specifically intended when a dam may suffer appreciable nonlinear strains throughout its carrying domain due to earthquake impacts. The large arch dams located in the region of strong earthquake shakings may be typical representatives of this necessity. According to the same codes, the other two approaches customised to be pseudo-static and elastic spectrum, are declared as appropriate to preliminary dams design or check-up phase. The main benefit of them is however their sufficiency to judge the necessity to take up or not the non-linear approach and if not, to assume an appropriately safety margin for dam design. Often, the preliminary dam design i.e. the said two approaches are taken as final dam stability consideration. The flow chart of two approaches is illustrated in Plate 1 hereafter. This paper does not cover time history analyses of large dams. Standard Response Spectra method is usually based on peak ground acceleration values for a dam location taken either from the national hazard standards or from the national hazard earthquake maps. At the same time, the Site Response Spectra method necessitates special studies for a particular dam site. Regional geologic and seismo-tectonic setting, seismic history and local geological setting are only main inputs for site specific response spectra evaluation. Apart from accompanying uncertainties, the inventory of as recorded earthquakes, including magnitude, distance, focal depth, ground motion attenuation, elastic and shear modulus, and often damping characteristics of terrain, should be studied in the Site Response Spectra instances.

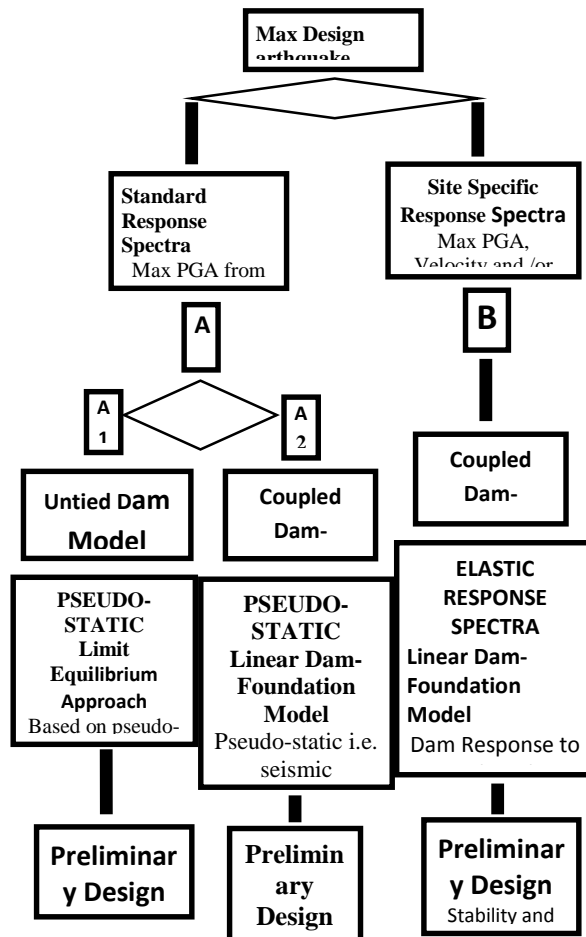
### **1. Standard Response Spectra**

Till to date publications about dams, Standard Response Spectra [A] is termed to be traditional method for earthquake design of dams. Here, MDE free –field ground motions, in their full intensity, are adopted to act upstream and downstream along the streambed i.e. along the dam reference plane coinciding to deepest dam section.

Yet, there will be another MDE with vertical free-field ground motions acting non-instantly with those of horizontal ones, which amplitudes may be taken as a fraction of those acting horizontally. Cross-stream ground motions are neglected within the traditional approach.

### 1.1. Model A1 of Standard Response Spectra

There are two branches of application of traditional method [A] both associated with pseudo-static or, seismic coefficient method. First one [A1] is untied dam model i.e. model of a dam founded on non-deformable base and intended mainly for stability analysis of solid dams. Hence, the method was customised to be suitable for Limit Equilibrium Approach within which, the stability of dam structure as a non-deformable body, is subjected to stability kinematics. In case of gravity dams made of conventional or roller compacted concrete or of masonry composite, the stability of dam body to sliding and overturning is usually examined. In traditional practice, there were established safety factors as a ratio between the forces resisting instability and those triggering instability. See Table 1 hereafter for more details.



This Limit Equilibrium Approach provides no direct information regarding deformations; it is implied that deformations are sufficient to induce the failure condition. It is well known that safety factor method for non-deformable body models is not applicable to embankments and arch dams. Yet, the “usual”, “unusual” and “extreme” load conditions are respectively aligned with max operation level of the reservoir, OBE loads, and probable max flood (PMF) loads or max design earthquake(MDE) loads.

The simultaneous combination of PMF and MDE loads is not customised as a design criterion. The Traditional Limit Equilibrium Method is often applied as a first trial for new dams design or for rehabilitation design of existing dams, and its role is found there as rather beneficially, primarily because of its time effectiveness. Since the demand-capacity ratio (DCR) to concrete, its application is often limited to checking the dams’ stability within preliminary design phase of a dam. Although it is not generally dominated, only the approximate fundamental mode of vibration of dam, known also as *equivalent lateral force method*, is customized within the pseudo-static approach of seismic response of a dam [A1].

Here, fundamental mode of vibration is represented by equivalent lateral force acting on dam. Hence, the seismic coefficient applicable for a dam is expressed as a product of fundamental mode of vibration and peak ground acceleration, resulting in pseudo-spectral seismic coefficient. Consequent to approximate base mode of vibration adopted for checking up the dam response, pseudo-spectral seismic coefficient is to be linearly height-varied beginning from zero value at the dam bottom to full value at the dam crest. Hence, the lateral force comes as a product of spectral seismic coefficient and weight of dam per unit surface area.

No dam damping ratio is aligned with method [A1] of seismic analysis. Here, it is worth to note that initial phases of traditional procedure ignored the dynamic behavior of a dam by adopting uniform distribution of spectral seismic coefficient effects along the height of dam. That resulted in not fully consistent stress distribution along the dam height which gives higher stresses nearby the dam base [A1] and their decrease with the dam height. In Dam models, more consistent dam stress analysis would be with height-wise variable pseudo-spectral seismic coefficient.

Fig.2 hereafter is more illustrative to this effect. Still, the height-uniform seismic coefficient may give safer margin when limit equilibrium analysis [A1] is conducted for examination of dam stability safety against sliding.

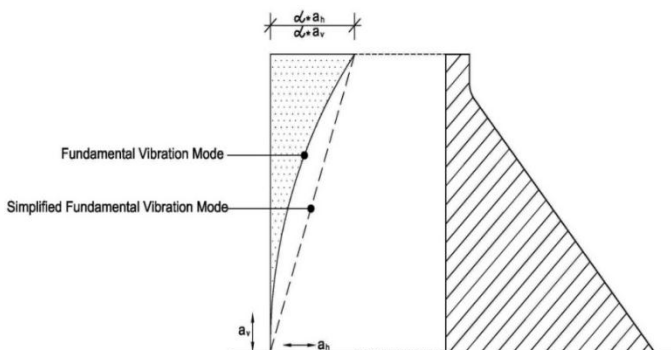


Table 1

**Average overturning and sliding criteria recommended by internationally recognised codes**

Load Conditions	Safety Factor (SF) Against overturning	Safety Factor (SF) Against sliding	Resultant Location at Base
Usual Load Conditions	2	2	Middle1/3
Unusual Load Conditions	1.7	1.5	Middle1/2
Extreme Load Conditions	1.3	1.1	Within the base

Along with the foregoing principles, Central Water Commission (CWC) recommended the Seismic Hazard Guidelines intended to serve the State Design Offices while dealing with rehabilitation designs of dams included in Dams Rehabilitation and Improvement Program (DRIP). Whereas PGA valued seismic coefficients are much smaller than the simplified ordinates of pseudo-acceleration response spectra for range of intense ground motions with vibration periods up to 1 sec, the height-variable diagram of those, was assumed to range from zero value at the dam footing until 1.5 times of PGA specified in National Seismic Map. The Table 2 and Fig. 2 herein give more details about the issue.

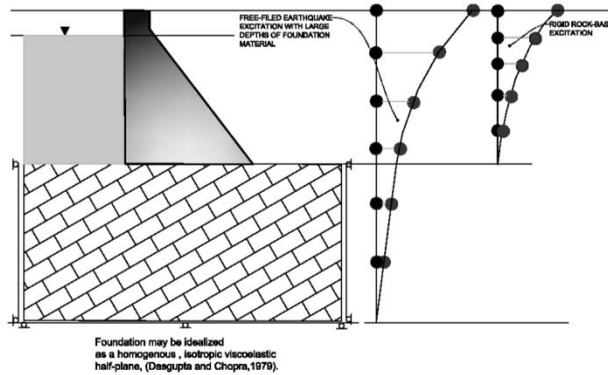


**1.2. Model A2 of Standard Response Spectra**

The second branch of standard response spectra [A2] load conditions is dealing with coupled dam-foundation models of dams i.e. dealing with dam body and foundation structure as compound model of behaviour. Damping of dam-foundation model as well as simplified ordinates of pseudo-acceleration response spectra was assumed to range from zero value at the dam footing until 1.5 times of PGA specified in National Seismic Map. Although it is still aligned with preliminary design consideration, this approach is more confident than that discussed for limit equilibrium models. With modern computing technology at our thresholds, the dam-foundation model offers much more possibility to analyse the stress outputs throughout the dam body and the interacting rock mass for overall range of static and combined static-dynamic load conditions. This may be applicable for all type of dams, including those designed to be embankment and arch dams. What still remained to be resolved for coupled dam-foundation models, they are codes-regulated stability criteria for their numerical alliances. Here, it is well known premise that numerical convergence of the model strictly corresponds to physical stability of compound dam structure. However, in case of converging models, the quantification of stability criterion remains to be still evaluated. The difficulty may arise due to separate approaches customised for subsurface medium of a dam to solid one extending above-surface. The least separation can be located for earth fill and rock fill dams which may be soil-rock and rockfill-rock structures. More pronounced separation currently exists for gravity dams and arch dams which can be rock mass underlined. The stability of subsurface sections of dam structures is construed by stress levels which are defined by Coulomb-Mohr, Drucker-Prager or Hoek-Brown failure criteria. At the same time, the concrete mechanics approach used defining the stability of a concrete dam mainly using allowable stress approach as a basis. Here, the allowable stresses are prescribed for expected service load conditions which are usually classified as usual, unusual and extreme ones.

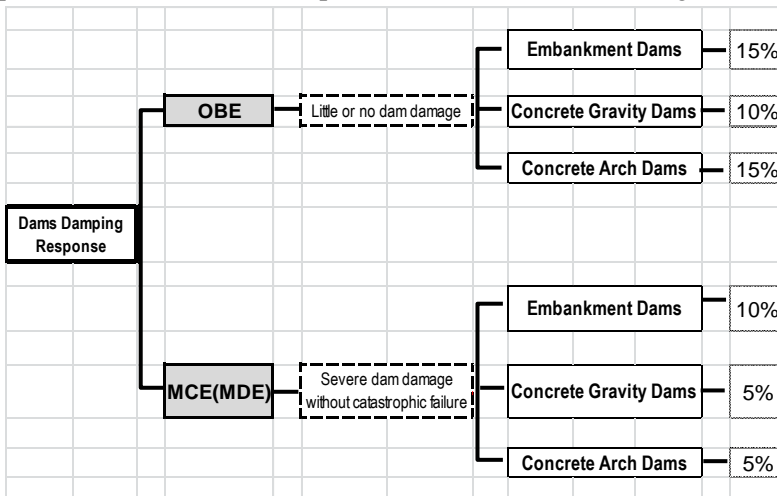
Seismic Zone	PGA Induced Ground Motions As a fraction of acceleration constant				Pseudo-Spectral Seismic Coefficients corresponding to dam crest (Simplified fundamental vibration mode)			
	Concrete Dams		Earthen Dams		Concrete Dams		Earthen Dams	
	$a_h$	$a_v$	$a_h$	$a_v$	$\alpha_{Dh}=1.5*a_h$	$\alpha_{Dv}=1.5*a_v$	$\alpha_{Dh}=1.5*a_h$	$\alpha_{Dv}=1.5*a_v$
II	0.06	0.04	0.06	0.04	0.09	0.06	0.09	0.06
III	0.12	0.08	0.12	0.08	0.18	0.12	0.18	0.12
IV	0.15	0.10	0.15	0.10	0.225	0.15	0.225	0.15
V	0.24	0.16	0.24	0.16	0.36	0.24	0.36	0.24

Often, as a criterion for linear analysis of a concrete dam, the demand-capacity ratio is instituted too. The demand-capacity ratio (DCR) represents the ratio between the computed tensile stress for a particular discrete point of a model, and designed tensile strength of a concrete. According to customised practice, the  $DCR \leq 2$  would be general prerequisite for linear law applied throughout a concrete model subjected to extreme load conditions which are combined with MDE.

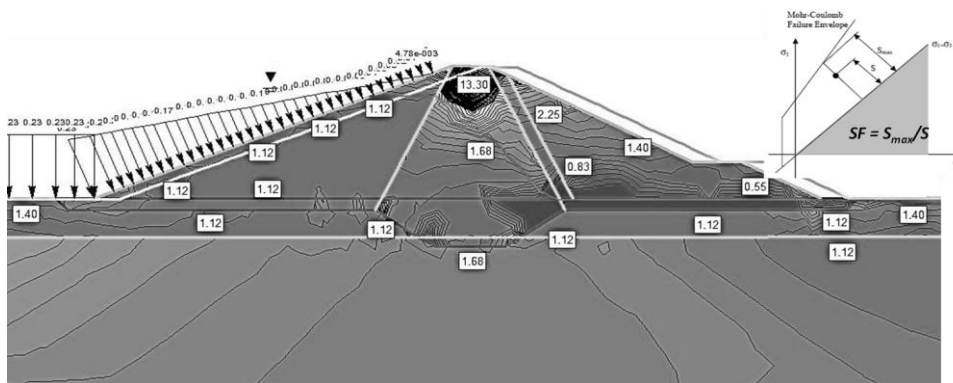


**Fig. 3. Solid dam finite element procedure**

Concurrently, the linearity/nonlinearity of subsurface part of the model is customised to be contingent to non-exceedance /exceedance of adopted failure criterion. Under such multidisciplinary approaches for solid dams, the compound structures and their numerical models is recommended to have dual definition of safety factors, i.e. (a) as the ratio of computed stress and that resulting from the above failure criterion, for the entire dam foundation model, and (b) as the ratio of computed compressive stress and adopted allowable compressive stress for concrete, where applicable, or as the ratio of computed tensile stress and adopted allowable tensile stress, again where applicable.



Until the relevant codes, the margin of  $DCR \leq 2$  for safety factors for both approaches (a) and (b) is recommended for quasi - static load conditions. There, only very isolated and limited areas of a model having outputted  $DCR \leq 1$  can still secure the stability of a compound dam structure.

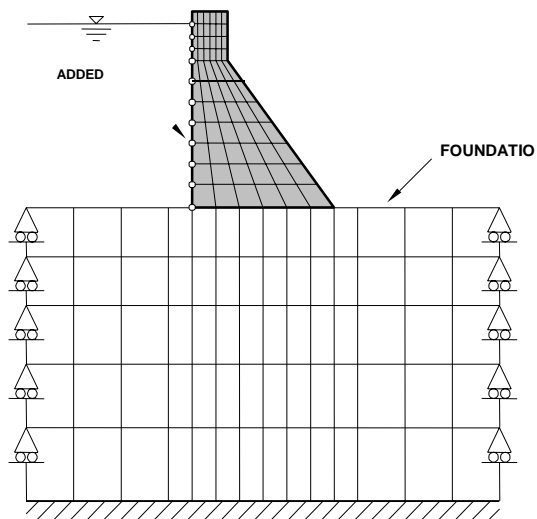


Free field earthquake excitation effect for gravity dam itself and for its appropriate foundation area, as far as their critical damping, may differ. The question is: how much earthquake excitation and damping for coupled dam-foundation model we have to apply? Since we have two areal fragments in question, there is flexibility, damping and inertial effects appropriated to of dams, while the same there is for substructure area. The dams can be gravity one, earthfill, rockfill or, masonry one. In consequence of that, the impedance matrix or slip criteria on, is arising between the dam and substructure existing together with a dam. According to Dasgupta and Chopra, 1979, (Reference 8), foundation may be idealized as homogenous and isotropic viscoelastic half plane. Again, according to Dr. Broun E.T and Dr. Evert Hoek, as well as by Dr. Nick Barton, a semi inhomogeneous or anisotropic idealization can arrive at. According to them, the inertia and damping of the foundation rock region as well as its flexibility of dam structure can be estimated.

Recommendation for damping ratios of embankment, concrete and concrete arch dam according to international standards: Damping is to be outlined to the effect of internal friction, imperfect elasticity of material, slipping, sliding, etc. in reducing the amplitude of vibration of the structure, and is expressed as a percentage of critical damping. Safety factors are exemplified on a compound earthfill dam model, illustrated here before. Because of software limitations, instead of triangular distribution of pseudo-spectral seismic coefficient with rate of 0.18 coincident to dam crest, the uniform value of 0.22 was adopted along the dam height. This was assumed as still permissible departure from pseudo-spectral linearity when analysing earthfill dams.

### **Site Specific, Alias Elastic Response Spectra**

Here, the reference is made to flow chart [B] of Figure 1, remaining with “*site specific response spectra*”. According to practice customised so far, response spectrum analysis is an approach estimating peak response of a dam structure due to transient base motions. It is a peak of linear dynamic response of a single freedom oscillator over a range of natural frequencies. It may be a spectrum of acceleration, the velocity or displacement. It is premised that a dam structure natural frequencies and vibratory mode shapes are representative of a single degree of freedom oscillator. The response spectrum procedure is inherently an approximate solution method. Typically, the method is used when a conservative estimate of peak dam response is required for design purposes. It is strictly a linear design procedure, often termed as “*elastic response spectra*”. Although the method is then still aligned with preliminary design phase, it is taken as more confident than those of standard response spectra earlier discussed in this paper. To this effect, the method, whereas always aligned with coupled dam-foundation models, would require discretization and idealisation of these models in first instance. The final elements discretization method is an integral part of new or rehabilitated dams design. Meanwhile, there were so far, customised the two approaches for evaluation of site specific spectra, the deterministic and probabilistic one. Theoretically, the elastic spectrum method is conducted for a known transient base motion by performing transient dynamic analysis on a number of spring-mass-damper systems, each representing a single response frequency. In other words, when a dam vibrates under the base excitation force, it dissipates energy by damping the motion. The well-known motion equation containing mass matrix, damping matrix and stiffness matrix, which summation is equivalent to applied forces matrix, describes the aforesaid transient dynamic analysis.



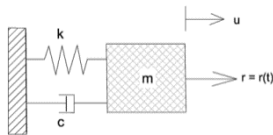
The concrete dam to an earthquake loading includes the concrete arch, the foundation rock and impounded water. The dam–water–foundation system may be analyzed by the *standard* and finite element procedure and the *substructures*. The *substructure method* permits more rigorous analyses of dam–foundation and dam–water interaction effects. It may be represented by viscoelastic half space.

### Fig. 6. Standard Method of 2-D Gravity Dam

The *substructure method* considers not only the foundation flexibility but also includes the damping and inertial effects of the of the foundation rock. In the subsurface method of dam analysis, the impedance matrix of the foundation rock region is employed to represent dam- foundation interaction effects (Reference (9)). The impedance matrix (or frequency - dependent stiffness matrix) includes both the inertia and damping of the foundation rock region as well as its flexibility. The foundation model therefore is represented by the dam–foundation rock interface discretized into a set of boundary elements whose nodal points match the finite element idealization of the dam (Reference (9)).

Base motion of equation is delineated as:

$$m\ddot{u} + c\dot{u} + ku = -m\ddot{u}_b \text{ i.e. } \ddot{u} + 2\zeta\omega_n\dot{u} + ku = -m\ddot{u}_b$$



$$\zeta = \frac{c}{c_c} = \frac{\text{Actual Damping}}{\text{Critical Damping}} \quad c_c = 2\omega_n m \quad \omega_n = \sqrt{k/m}$$

$\omega_n$  = The highest eigenvalue on the model

Velocity :  $\dot{u} = du/dt$       Acceleration:  $\ddot{u} = du^2/dt^2$

As for damping ratios, they are mainly put in contingency of a dam structure to dissipate vibrating structure energy by shearing capacity and of volumes of reservoir interacting with dam. It is unsuitable for practical application.

The *standard* method employs massless foundation rock within incompressible finite element method model from impounded water with the effects of foundation flexibility (Reference (3)). Since no wave propagation takes place in the massless

foundation model, the seismic inputs obtained from the earthquake motions recorded on the ground surface scaling or spectrum-matching procedures. Its inertia and damping effects are neglected. The average period of seconds and spectral acceleration (spectra for 5% damping), and average acceleration coefficient and natural period of vibrating in seconds, from the rock to soft material, were illustrated on Plate 7 hereafter. Another issue that remained to be discussed is the modal superposition method which is used to compute earthquake response of dams' within their elastic behaviour. Here, primary feature of modal analysis is that the total response of a dam is obtained by combining the response of individual modes of vibrations calculated separately. It is always implied that each mode of vibration say of X, Y and Z component is accompanied by max response output. In these situations, the dam structure can be analysed via simplified response-spectrum of modal-superposition method. Here, the response quantities of interest are peak displacements, element stresses, element forces and moments. Since these modal responses do not occur at the same time during the earthquake excitation, they can be combined using complete quadratic combination (CQC) or, the square of root of sum of the squares (SRSS).

The CQC modal combination can be used if the duration of strong motion portion of shaking event is several times longer than fundamental period of dam and if the design response ordinates vary slowly over wide range of periods. On the other hand, the SRSS method could be better fitting the structures for which the modal periods are well separated. Each dam modal superposition case should be considered appropriately contingent to dam structure response and duration of the vibration event. At last, the total response of a dam is always under combination of static and dynamic load conditions. Hence, the response quantities evaluated by means of CQC or SRSS superposition should be still combined with quantities due to static and dynamic load. The main issue here might be involving the rock mass region into a unique analysis. The rock mass region interacting with dam may be subjected to elastic stresses, elasto-plastic stresses or viscoelastic stresses whilst static load conditions. In addition, the rock mass may be subjected to *in situ* stresses with differing of their componential values. Under the circumstances, the software intended to dam analyses with elastic response spectra inputs should be enabled to combine the resulting stress in a dam structure via *standard* finite element procedure or the *substructures method*. The Indian Standards Designs were made more rationally by utilizing fully the available data from analytical procedures, laboratory and field investigations and measurements of the behavior of structure in service. It is essential that design loads are carefully chosen to represent, as nearly as can be determined the actual loads that will act on the structure and that all the resistive forces used in design represent as accurate an evaluation as possible. It is, in addition, necessary that dams be frequently inspected (as in all cases, uncertainties exist regarding such factors as loads, resistive forces or characteristics of the foundation) and adequate

observations and measurements be made of the structural behavior of the dam and the foundation to ensure that the structure is safe at all times.

#### **4. Conclusions**

The paper focused on three methods which can be suitable for limit equilibrium method and linear elastic analysis of dams under vibratory loads.

Limit equilibrium approach [A1] is using the standard response spectra as input. This is a modality of pseudo-static method, with height-variable pseudo-spectral seismic coefficient. The limit equilibrium method is taken as practical method to stability analysis of solid dams. Coupled dam-foundation model which is standard response spectra inputted too [A2]. This is second model of pseudo-static method with height-variable pseudo-spectral seismic coefficient. The lateral force is again a product of pseudo-spectral seismic coefficient and unit weight of a dam. The [A2] approach is more confident than [A1], since it is dealing with deformable bodies and is applicable both for stability and stress analysis of dams. The third approach defined to be [B] line of Plate 1, is elastic response spectra. Its output is conservative dam response to earthquake excitation. This approach is conducted for known transient dam motions. Superposition method is applied for combining the stresses and displacement of interest belonging to different time modes of vibration. It is to note that outcome had come mainly from concrete mechanics engineer. Thus, the earthquake loads impacts to supporting rock mass should be further explored. Until the new theory arrival, the authors of Dr. Broun E.T and Dr. Evert Hoek, as well as by Dr. Nick Barton, should offer supplementary research of the issue about inertia and damping of the foundation rock region as well as its flexibility of dams.



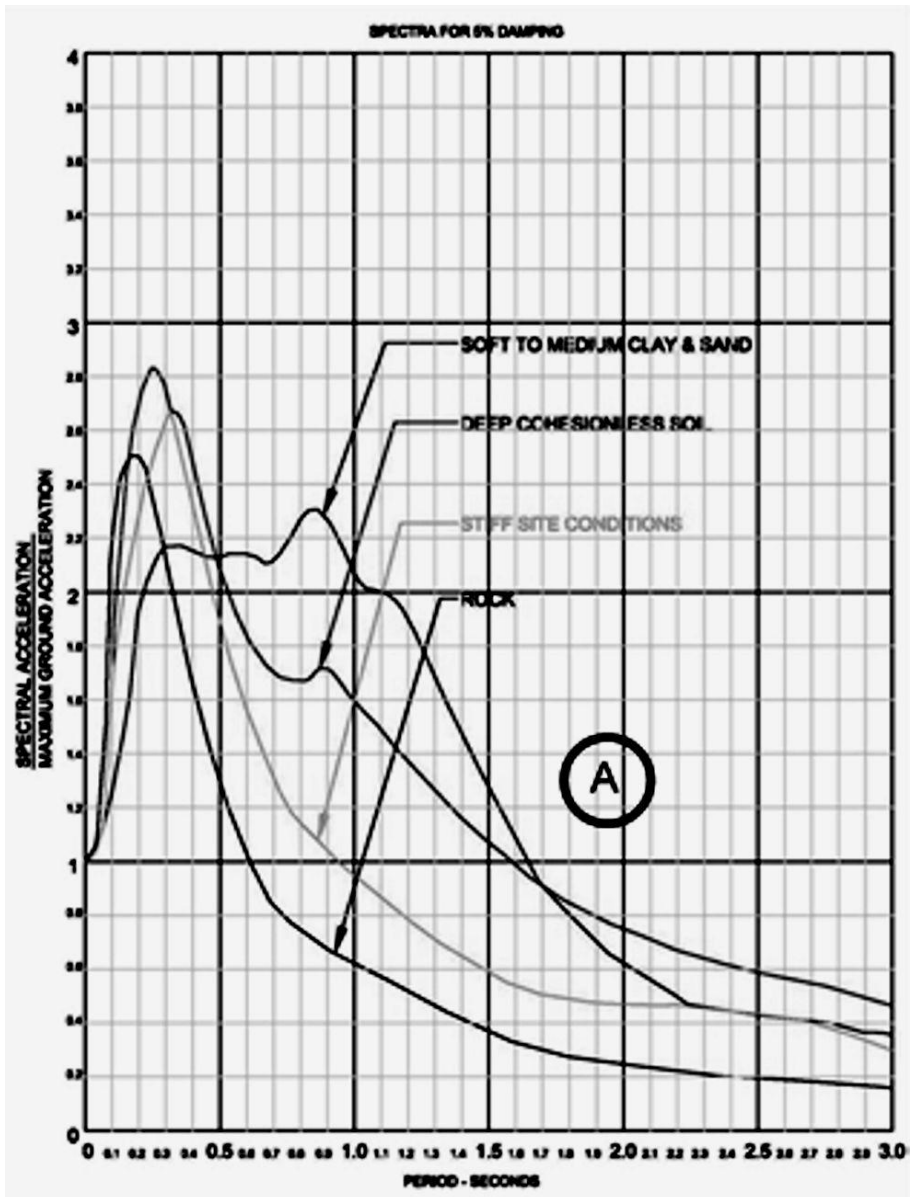


Fig.7. [A] Average Acceleration Spectra. US Corps of Engineers, Response Spectra for Concrete Hydraulic Structures

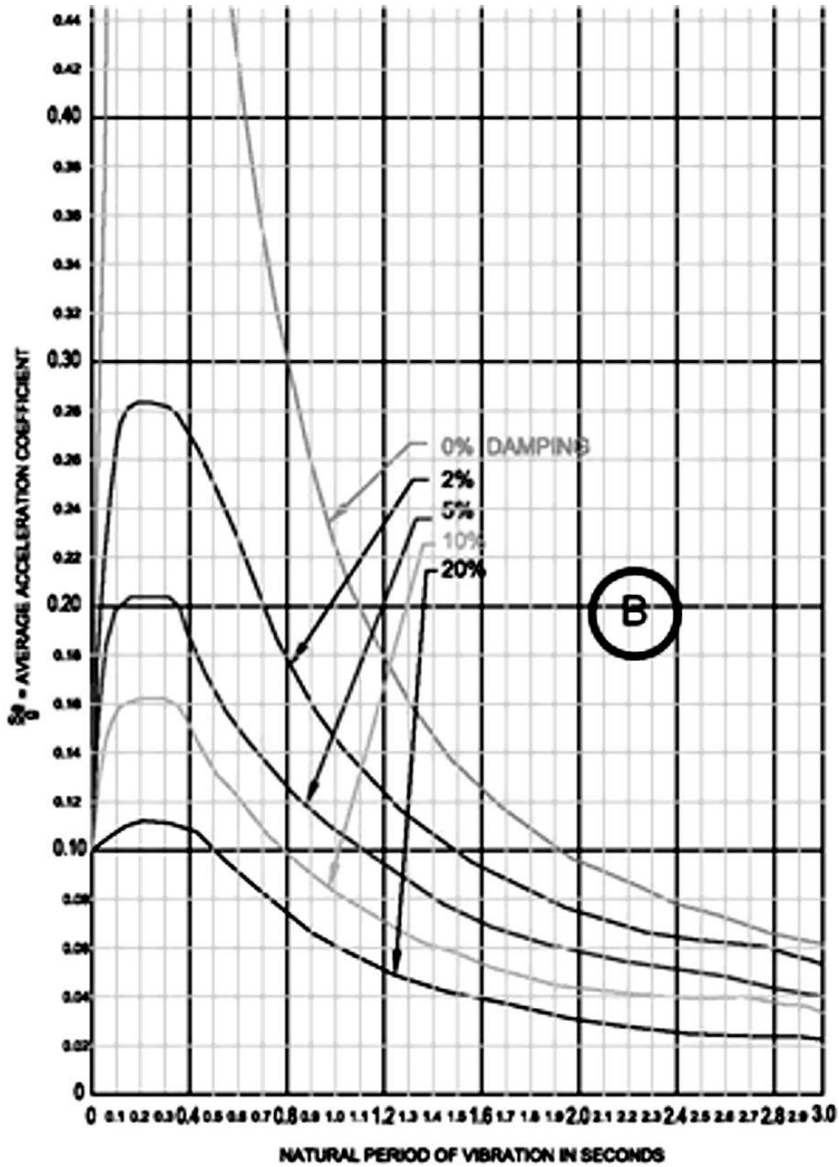
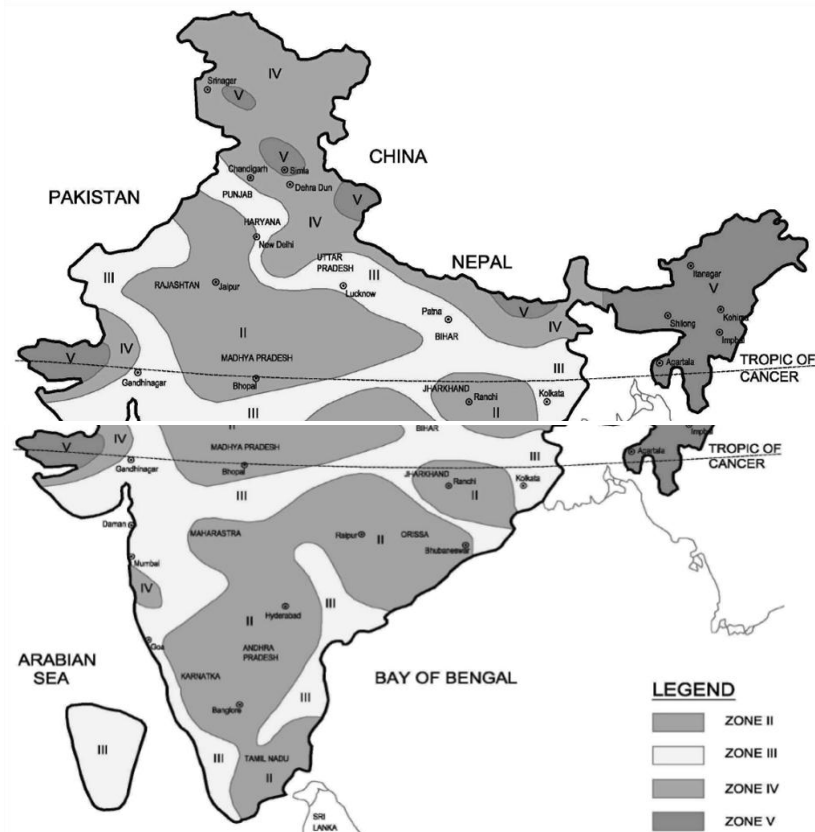


Fig. 8. [B] Indian Standard IS: 1893-1984. Criteria for Earthquake Resistant Design of Structures

### 3. Standard Response Spectra Which Is Used In India

Intensity Scale as per current Indian Standards IS:



**Zone 1 - Not Noticeable:** The intensity of the vibration of below the limits of sensibility.

**Zone 2 - Scarcely noticeable:** Vibration is felt only by individual people.

**Zone 3 - Weak, partially observed only:** The earthquakes is felt indoors by a few people.

**Zone 4 - Largely observed:** The earthquakes are felt indoors by a many people, outdoor by a few.

**Zone 5 - Awakening:** The earthquake is felt indoors by all, outdoors by many.

## References

1. Indian Standard IS 1893 (Part 1): 2002, Criteria for Earthquake Resistant Design of Structures.
2. Indian Standard IS 6512-1984 (Part 1): 2002, Criteria for Design of Solid Gravity Dams.
3. Anil K. Chopra 1988. Earthquake response analysis of Concrete dams, 15<sup>th</sup> Section of Advanced Dam Engineering for Design, Construction, Engineering Book, edited by Robert B. Jansen, 1988.
4. United States Society on Dams Materials for Embankment Dams, January 2011. Materials for Embankment Dams.
5. Robin Fell, Patrick Mac Gregor, David Stapledon, Graeme Bell, 2005. Geotechnical Engineering of Dams. A.A. Balkema Publishers.
6. Robert D. Cook, David S. Malkus, Michael E. Plesha, Robert J. Witt, 2002. Concept and Applications of Finite Element Analysis, fourth edition.
7. E. Yıldız & A.F. Gürdil, 2012. Review on Seismic Design of Concrete Gravity or RCC Dams with Design Examples. Temelsu International Engineering Services Inc., Ankara, Turkey.
8. US Army Corps of Engineers, 2007. Earthquake Design and Evaluation of Concrete Hydraulic Structures. Engineer Manual.
9. US Army Coprs of Engineers. Engineering and Design. Time history Dynamic Analysis of Concrete Hydraulic Structure. 22 December, 2003.
10. The Article was reprinted from Dam Rehabilitation and Improvements Project (DRIP) – First National Dam Safety Conference, 24 -25 March 2015, IC&SR Auditorium, IITM, Chennai, India. Compendium of Technical Papers.

## Acronyms:

MDE – Maximum Design Earthquake, OBE – Operation Basis Earthquake, PMF – Probable Maximum Flood, DCR – Demand Capacity Ratio, CQC – Complete Quadratic Combination, SRSS – Square of Root of the Squares, CWC – Central Water Commission of dams rehabilitation and improvement program of India, SDO - State Design Offices of dams rehabilitation and improvement program of India, DRIP - Dam Rehabilitation & Improvement Project.

## **STUDY OF PRODUCTIVE SERIES DEPOSITS OF GUNASHLI FIELD IN THE LIGHT OF SEQUENCE-STRATIGRAPHY**

**L.N. Khalilova**

*Azerbaijan State Oil and Industry University  
Baku, Azerbaijan*

### **Abstract**

Exploration works in the Caspian sea held more actively for the last years in order to outline hydrocarbon perspective formations and horizons in Productive Series (PS) without high-cost drilling require the use of more accurate state-of-the-art tools of sequence stratigraphy and seismo-stratigraphy analysis. The paper deals with results derived by use of sequence-stratigraphy tool based on well logging data (log curves of Spontaneous Polarization (SP) and Gamma-Ray Log (GR)). Identification, correlation and synchronization of genetically tied facies within chronostratigraphic limits has been conducted for study of lithological peculiarities in upper portion of PS of the Early Pliocene across Gunashli field, which is attributed to Absheron-Pribalkhan tectonic zone. Major oil and gas accumulations have been attributed to facies of definite sedimentary system tracks.

**Key words:** sequence-stratigraphy, parasequence, sedimentary system tract, productive series, lithological features and facies, chronostratigraphic limits

### **Introduction**

It is known that the major part of oil, gas and gas-condensate extraction in Azerbaijan is done from Productive Series deposits of Early Pliocene. In this respect, the detailed study of Productive Series (PS) deposits and their generation process gains a special value. For this for the recent years we widely use new, highly-informative analysis tools: seismic and sequence stratigraphy [1-6]. Seismic stratigraphy enables us to divide the sedimentary cover into sedimentation units (SU), which borders are chronostratigraphic (acoustic) boundaries transforming in some places into unconformity surfaces. The latter create stratigraphic frame of sedimentary cover making it possible to fulfill correlation of sedimentary units of various age [2]. Sequence-stratigraphy outlines stratigraphic units and their components in form of a sequence of

sedimentary tracts. Sequence-stratigraphy as a tool allows to fulfill more accurate chronostratigraphic division by log diagrams to outline perspective hydrocarbon saturated horizons in a range of parasequences and outlining of stratigraphic traps. The units of sequence-stratigraphy analysis reflect periodicity generated by relative sea level fluctuations through outlining of para-sequences and involved sedimentary system tracts.

This enables us to predict facies distribution and makes easy the detailed correlation and mapping of deposits. Sequence-stratigraphy takes into account sedimentation process in an environment [1, 3-6].

Sequence-stratigraphy envisages three operations: outlining of three major unconformity surfaces and conformity borders (by seismic-stratigraphic analysis), lithological analysis by well logging data and biostratigraphy analysis [1, 3-6].

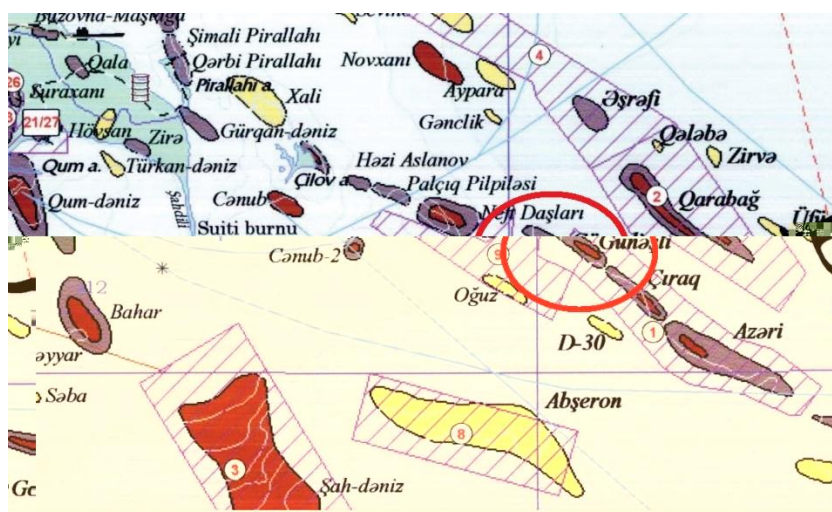
This study is devoted to identification of lithological characteristics of upper portion of Productive Series of Early Pliocene by use of sequence-stratigraphy tool. The target of this study is Gunashli field (Fig.1).

The aim is to reveal, correlate and synchronize genetically tied facies within chronostratigraphic limits. The study target is the deposits of Fasila suite, horizons X, IX, VIII and VII of Balakhany suite to which the oil accumulations of this area are related. Gunashli field is situated in the south-eastern part of Absheron archipelago, at 12 km distance from Neft Dashlary area and 120 km from Baku.

Anticline uplift Gunashli was discovered through 1958-1963 as a result of seismic survey. Exploration drilling in this area started in 1977. Appraisal works commenced in 1979 and testing operations started in 1980. Productive Series deposits have been recovered at 1300-4300 m depth and relatively well studied. Productive Series overlays eroded surface of Sarmatian deposits of 55 m thickness. Hydrocarbon presence in Gunashli structure is related to PS deposits.

This has been evidenced by testing in well № X. From well № X for the first time oil was produced from Balakhany Suite – 230 tons per day. Later 320 tons of oil per day was produced from Balakhany suite of well № XX. Fasila suite deposits accumulating the major part of oil resources have been recovered by all exploration and production wells.

Commercial oil and gas-condensate accumulations have been recovered in the following horizons and suites of Gunashli field: Qala<sub>3</sub>, Kyrmakyalty, Kirmakyustu, Fasila, Balakhany (horizons X, IX, VI, V). The type of oil and gas-condensate fields are tectonically sealed. In general, in geological section of Gunashli field oil and gas accumulations were identified in 17 horizons and PS suites. Oil-water and gas-water contacts are present in individual tectonic blocks at various depths. Production from the field started in 1980.



**Fig. 1. General scheme of Gunashli field location**

## Methods

At the first stage of the study Spontaneous Polarization (SP) and Gamma Log (GL) data have been processed. At this, on GL diagrams acquired from Gunashli X-1, Gunashli X-2, Gunashli X-3, Gunashli X-4 we have delineated the limits of parasequences, transgression surfaces and surfaces of maximal flooding. Parasequences boundaries indicate the end of previous (underlying) sedimentary parasequence and the start of new one.

The point in which the rate of accommodation space generation exceeds the rate of sedimentation for the reason of relative sea level increase is defined as transgressive surface. As the rate of sea level increase slows, the sedimentation system reaches the point when accommodation is filled by sediments. This point of maximal elongation of coastal line is defined as a surface of maximal flooding. Delineation of these surfaces and boundaries later makes it possible to identify types of sedimentary system tracks at various depths of the above indicated wells. The next stage of the study consisted in correlation of similar boundaries identified earlier and surfaces by GL diagrams for wells Gunashli X-1, Gunashli X-2, Gunashli X-3 and Gunashli X-4 (Fig.2-3). The analysis of drawn correlation profiles have been done with further delineation of system tracts of sea-level high-stand, transgressive system tract and system tract of sea-level low-stand. Depositions on shelf developed during the period of relative sea-level growing faster

than the rate of sedimentation is defined as transgressive system tract. Interval of low sea-level is defined as low-stand while deposits of this period is defined as system tract of low-stand of sea-level. Relative sea-level is slowly increases, however the rate of sediments inflow is relatively high.

The period of high sea-level during the cycle and layers deposited during this period are defined as the system tract of high-stand systems. Analysis of drawn correlation profiles outlined that in Gunashli field from VII to IX horizons of Balakhany suite the complete parasequences are present in distinction to the X horizon and Fasila suite, where only incomplete parasequences are observed.

Analysis has been done by use of final data for well logging in Gunashli X-1, Gunashli X-2, Gunashli X-3 and Gunashli X-4 wells.

### **Results and discussion**

In Gunashli field high values of porosity and oil-gas saturation coefficient are characteristic for Fasila series in well X-1 evidencing oil presence in formation. Fasila series consists of large- and middle-grained sandy-aleuritic layers alternating with clay of relatively small thickness. Fasila with 100-140 m thickness is recovered at 2657-3550 m depth interval and accumulates the largest oil reserves in the field. At 2657-2765 m depth interval the system tract of sea-level low-stand and transgressive system tract are delineated. The similar picture is observed in other above indicated wells also. Therefore, we may infer that only incomplete parasequences are present in Fasila series. Lithology of Balakhany suite is represented by alternation of sandy-aleuritic and clay rocks. In Balakhany suite section the horizons V, VI, VII, VIII, IX, X are separated from each other by clay interlayers. Sand content of the suite reaches 40-50%. Balakhany suite has been recovered at 2000-3050 m depths, the total thickness varies within 610-750 m ranges. Horizon X is one of the most productive targets.

High values of porosity and oil presence coefficient are also characteristic for horizon X of Balakhany suite. The total thickness of horizon X is 75 m, in Gunashli X-2 well it is totally oil-gas saturated despite the fact that high resistivity values in this horizon in Gunashli X-1 and X-4 wells evidence water presence in formation. The boundaries of sequence and transgression surfaces are delineated here, enabling us to outline system tracts for low-stand sea-level and transgressive system tracts.

Horizon IX of Balakhany suite is also under commercial development. Its thickness reaches 100-130 m. Horizon IX of Balakhany suite in Gunashli X-1 and Gunashli X-2 wells has optimal values of porosity and oil-saturation coefficient and this horizon has been considered as oil-gas bearing zone. Porosity increases towards the low part of horizon. However, in GL diagram for Gunashli X-4 well we observe deviation to the right evidencing the presence of clay in this suite. We observe here all three system



tracts indicating the presence of complete parasequence. Clay and clayey sand rocks are dominating here. The major part of horizon IX of Balakhany suite embraces the system tract of high-stand sea-level. Depth interval of 2758-2766 m in Gunashli X-3 well are characterized by high values of clay content and is considered as water-saturated. The same values are observed in wells X-2 and X-4 of Gunashli field. Horizon IX in Gunashli X-1 well is represented in a foot part by a system tract of high-stand of sea-level of underlying parasequence upward the section replaced by a system tract of low-stand sea-level of overlying complete parasequence. The horizon finishes also by a system tract of high-stand sea-level. Thickness of horizons VIII, VII, VI and V buried over horizon IX are vary within 70-140 m ranges. Horizons VII and VIII of Balakhany suite are represented by clay layers and not considered as oil-gas perspective. In all three wells in indicated suites we observe complete parasequence evidenced by the system tract of high-stand of sea-level, low-stand of sea-level and transgressive system tract. Horizons VII and VIII in well Gunashli X-1 are made by sandstone and sandy-clay siltstone. Porosity values vary within the ranges from 0.187 to 0.223, oil-gas saturation values vary from 0.420 to 0.653. Within 2391-2412 m interval of horizon VIII we observe decrease of indicated values evidencing the presence of water interlayers consisting mainly from sandy-clay siltstone.

### **Conclusions**

This study enabled us to derive the following conclusions:

- Fasilaseries is represented by alternation of three incomplete parasequences. Within its limits 12 reservoirs have been delineated, of these 11 reservoirs are oil-saturated. Oil-saturated reservoirs have been outlined mainly in system tracts of low-stand sea-level, as well as in transgressive system tracts.
- Study of horizon IX of Balakhany suite identified that the whole horizon is represented majorly by transgressive system tract and system tract of high-stand sea-level. Of 4 reservoirs identified within transgressive system tracts two are oil-saturated. One more oil reservoir has been outlined within the system track of low-stand sea-level of complete para-sequence within horizon IX;
- Oil- and water- saturated reservoirs within horizons VII, VIII and X of Balakhany suite were considered as system tracts of low-stand sea-level;
- Studies of upper part of Productive Series outlined that major hydrocarbon accumulations in Gunashli field are in horizons VII, VIII, IX, X of Balakhany suite and Fasila series. It has been made clear that major accumulations of oil are attributed mainly to facies of system tracts of low-stand sea-level and more rarely to transgressive system tracts.

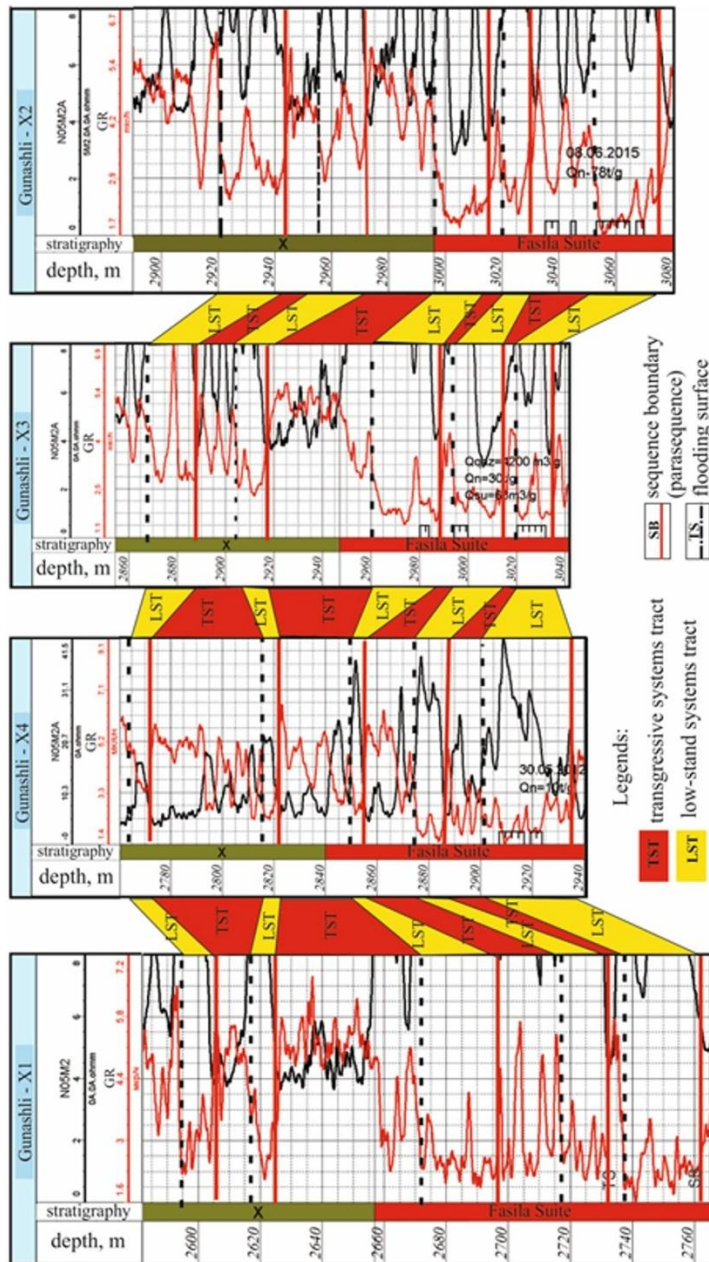


Fig.2. Correlation profile for Productive Series deposits (Fasila suite and horizon X of Balakhany suite) of Gunashli area

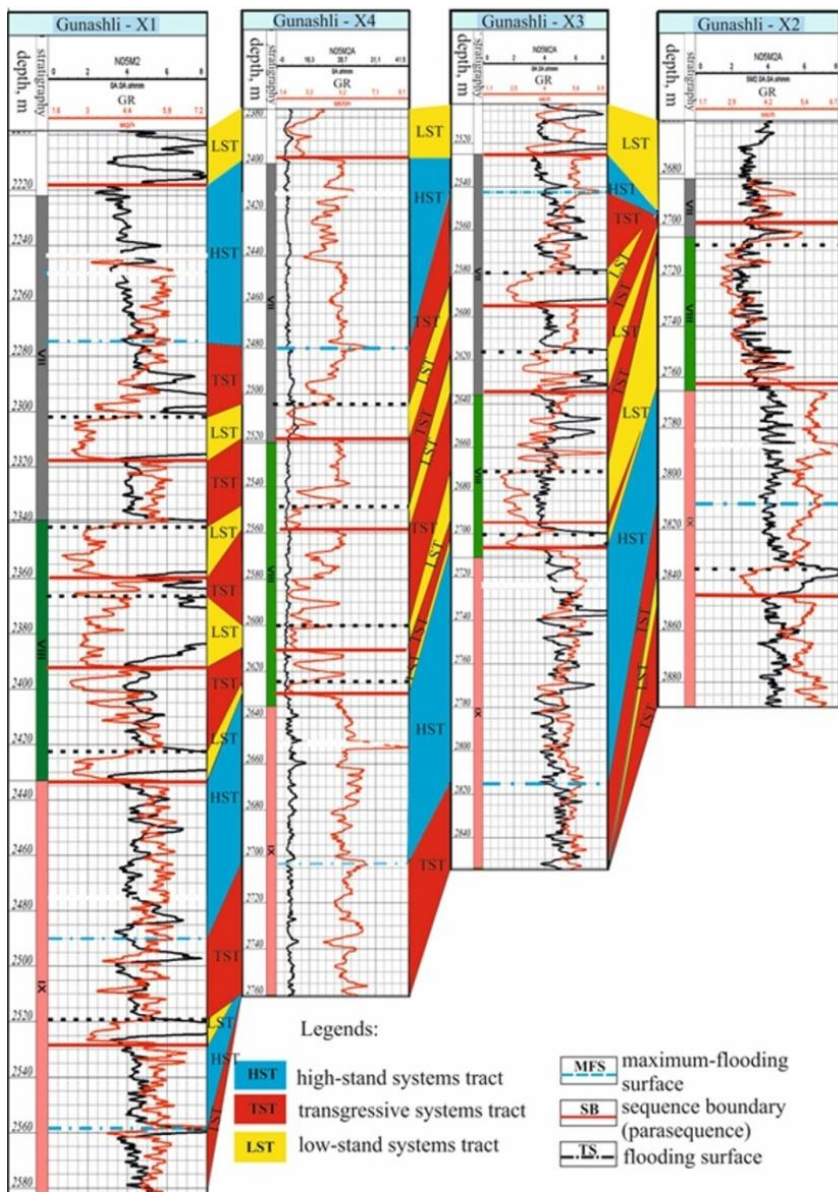


Fig. 3. Correlation profile for Productive Series deposits (Horizons VI - IX of Balakhany suite) of Gunashli area.

## References

1. R.R. Gabdulin, L.F. Kopayevich, A.V. Ivanov, "Sequencestratigraphy", Teachingguide, M.: MAKS Press, 2008, p. 113.
2. "Seismic stratigraphy", Edited by Ch. Peyton, Translation from the English under edition of N.Y. Kunin and G.N. Gogonenkov, Two volumes, Volume 1, 2, M.: Mir, 1982, p. 839.
3. K. Fisher, "Seismicstratigraphy and sequen cestratigraphy", Moscow, 2014, p. 114.
4. L.N. Khalilova, "Result sofsequence-stratigraphy and log faciesto olapplication to study of Absheron-Pribalkhan zone of up lifts", Azerbaijan Oil Industry, 2008, №1, pp. 58-63.
5. "Sequence Stratigraphy Termsand Concepts", Marjorie Levy, Editor, Chevron Petroleum Technolyco. December, 1991, pp.1.1-3.19.
6. J.C. Van Wagoner, R.M. Mitchum, K.M. Campion and V.D. Rahmanian, AAPG Metods in Exploration Series, No.7, Siliciclastic Sequence Stratigraphy in Well Logs, Cores, and Outcrops: Concepts for High-Resolution Correlation of Time and Facies, Amer. Assoc. Petrol. Geol., Tulsa, 1990, p.55.

## REGIONAL CLIMATE CHANGES AND HYDROMETEOROLOGICAL HAZARDS IN AZERBAIJAN

<sup>1</sup>Mahmudov R.N., <sup>2</sup>Aghayev Z.B.

<sup>1</sup>*The Ministry of Ecology and Natural Resources for Azerbaijan Republic,  
Hydrometeorological Scientific – Research Institute, H.Aliyev avenue, 10, Baku,  
Azerbaijan, e – mail: [rza\\_hidromet@mail.ru](mailto:rza_hidromet@mail.ru),*

<sup>2</sup>*Republic of Azerbaijan, Lankaran State University. H.Aslanov 50, Lankaran city,  
e-mail: [kreativagayev@gmail.com](mailto:kreativagayev@gmail.com)*

### Abstract

In the contemporary period changes, observed in the global climate system, continues negatively increase the dynamics of the natural hazards, which occur for the hydrometeorological processes. Nowadays the economy of not only special governments, but in general, the world has been damaged by the influence of climate changes. In 1991 – 2016 y.y. over the territory of republic in comparison with multiyear norm the average multiyear temperature has been consisted of +0.7<sup>0</sup>C, but in 2007 – 2016 y.y. it has been increased on +0.92<sup>0</sup>C. Over the republic on decreasing of the maximal of the maximal, minimal and annual water discharges in rivers with the high water and flood regime the minimal winter flows are increased.

**Key words:** Climate changes, temperature, multiyear norm, flood regime, water discharge.

For the results of the great number of researches, which are implemented in the direction of climate changes – one of the important ingredient of environmental factors, there have been defined that changes, observed in the global climate system, continues negatively increase the dynamics of the natural hazards, which occur for the hydrometeorological processes. Nowadays global climate changes and its damages to the people, water objects, biodiversity, agricultural infrastructural fields, in general, its natural, hazards are one of the greatest problems of the humanity. Today the economy of not only special governments, but in general, the world has been damaged by the influence of climate changes. The climate of the territory of Azerbaijan is the ingredient of the global climate system, and processes, occurring in this system, influence to the hydrometeorological condition of the country in the term of different time with the different intensity. In the territory of Azerbaijan there have been held the comparative analysis between the norm indicators of the main meteorological parameters, based on real observation data in 1961 – 1990 y.y., and the norm indicators of next years for different altitudes and regions [2, 6]. It enables to determine the lawfulness of the change in the temperature by the altitudes and regions.

As we see in the table 1 the multiyear temperature norm (1961-1990) over the republic consists of 12.3<sup>0</sup>C. In comparison with the multiyear norm there observes the increase of both the temperature and altitude interval indicators. Only in 2011 in comparison with the multiyear norm there has not been observed the increase of the temperature (0.0<sup>0</sup>C). But in 2010, 2015 years, which are considered as warmest years over the world, the increase of the temperature has been correspondingly consisted of +1.3<sup>0</sup>C and +1.6<sup>0</sup>C. But in 2016 this number has been +0.7<sup>0</sup>C. By the altitude intervals the most increase of the temperature is observed on 1 – 200 m altitude (+1.0<sup>0</sup>C and >1000 m).

*Table 1*

**The change of the temperature in comparison with the multiyear norm (1961 - 1990) by different altitudes over the territory of the republic in 1990 – 2016 and 2007 – 2016 y.y.**

Years	Altitudes, m					Over the territory of the republic
	0	1 - 200	201 - 500	501 - 1000	1000	
Multiyears norm 1961 - 1990	14.6	14.3	13.3	11.9	7.8	12.3
The differ from the multiyear norm (1991 – 2016) <sup>0</sup> C	+0.5	+1.1	+0.5	+0.4	+0.7	+0.7
The differ from the multiyear norm (2007 - 2016) <sup>0</sup> C	+0.8	+1.0	+0.9	+0.7	+1.2	+0.2

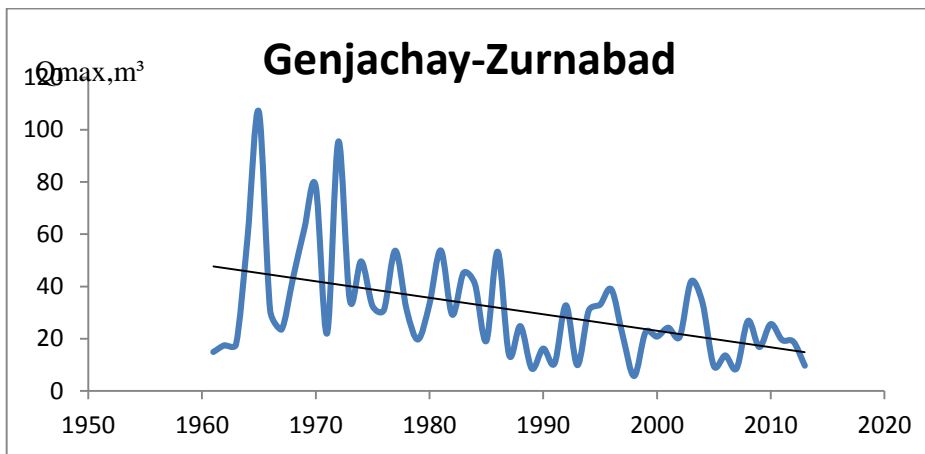
*Table 2*

**The change of the temperature in comparison with the multiyear norm (1961 - 1990) by different regions over the territory of the republic in 1991 – 2016 and 2016 y.y.**

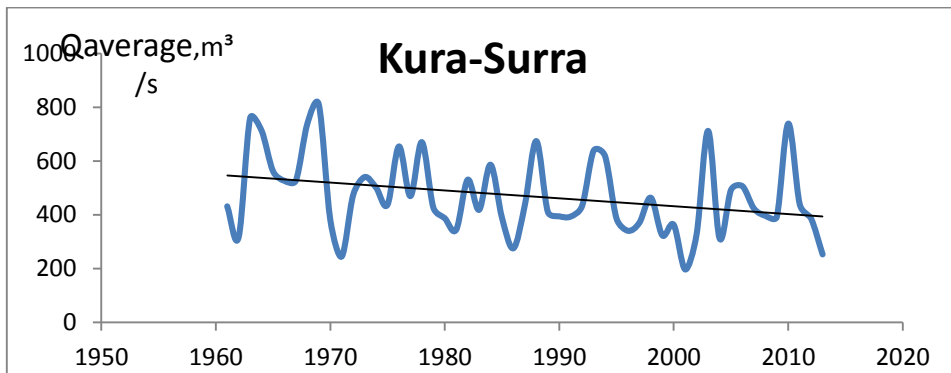
Years	Regions					Over the territory of the republic	
	Absheron Gobustan	Lenkoran-Astara	Great Caucasus	Little Caucasus	KurAraz		Nakchevan
Multiyear norm 1961 - 1990	14.5	12.9	10.7	9.2	14.3	12.4	12.3
The differ from the multiyear norm (1991 - 2016) <sup>0</sup> C	+0.6	+0.5	+0.4	+1.2	+0.5	+0.9	+0.7
The differ from the multiyear norm (2007 - 2016) <sup>0</sup> C	+0.7	+0.7	+0.7	+1.0	+1.0	+1.1	+0.87

In the table 2 there has been presented the change of the temperature in comparison with the multiyear norm over the separate regions. For the regions the most increase of the temperature observed in 2010 in Little Caucasus (+1.9<sup>0</sup>C), Kur – Araz (+1.8<sup>0</sup>C), in 2012 in Nakhchevan MR (+2.4<sup>0</sup>C) and in 2015 in Nakhchevan (+2.1<sup>0</sup>C) and in 2016 the most increase of the temperature has been consisted of +1.1<sup>0</sup>C, too. It is interesting that over the multiyear period there has been observed the increase of the mean multiyear temperature +0.7<sup>0</sup>C in Absheron – Gobustan, Lenkoran – Astara, Great Caucasus, +1.0<sup>0</sup>C and +1.1<sup>0</sup>C in Little Caucasus, Kur – Araz, Nakhchevan. In the comparative analysis of precipitations we see that in comparison with the multiyear norm (462 mm) the most increase of the precipitation is observed in 2016 (585 mm). The increase consists of 124 mm. Over 2008, 2012, 2013, 2014, 2015 years the precipitation has been less than the multiyear norm respectively on -31 mm, -23 mm, -45 mm, -70.5 mm, -42 mm. In 2016 the increase of the average multiyear precipitation has been consisted of +70.0 mm in comparison with the multiyear norm and the decrease of the precipitation is observed on the 201-500 m (-23.2 mm) altitude, but the increase on 501-1000 m (+1714 mm). In 2016 over the territory of the country the maximal temperature has been consisted of +43<sup>0</sup>C, but minimal -23<sup>0</sup>C. The maximal month precipitation has been consisted of 595 mm and the maximal speed of the wind 37 m/sec. Over the territory of the country there have been observed approximately 20 floods in 2016 y. In 2016 y expect of October, November and December months, over other months the temperature has been higher than the multiyear norm. In 19 January and 25 March in Baku the daily temperature has been higher than the multiyear norm on +10<sup>0</sup>C. But in 11 August in Baku the record multiyear indicator (+38.1<sup>0</sup>C) has been refreshed and consisted of 40.3<sup>0</sup>C. Last year firstly, there has been observed the increase of the level in Caspian Sea (+1.0 sm). A river water resource of any country as a natural factor is considered as a general supplement of the social – economical, sustainable development. In this point of view the right assessment of water resources, the clear forecasting of processes in water demand objects, resulted in the contemporary climate changes, the provision of the water demand in the country, its usage have a great social – economical, yet political importance [1, 3]. By the aim to research the influence of regional climate changes to the river flow, maximal, minimal, annual flows, which are main characteristics of the river flow, there has been analyzed the multiyear observation data of rivers, which are situated on different physic – geographical regions. The analysis of the multiyear trend of maximal ( $Q_{max}, m^3/sec.$ ), minimal ( $Q_{min}, m^3/sec.$ ), average annual ( $Q_{annual}, m^3/sec.$ ) water discharges in rivers shows over the republic on decreasing of the maximal, minimal and annual water discharges in rivers with the high

water and flood regime the minimal winter flows are increased Fig. 1. Such tendency is observed in the maximal water discharge (the decrease to 20 – 40%) over the spring high water period in the great part of world's rivers, including Southern – Western Russia's, Western Europe's territorial rivers. Over the winter low water period of rivers the increase of the minimal flow, first of all, is connected with the character of the contemporary climate changes.

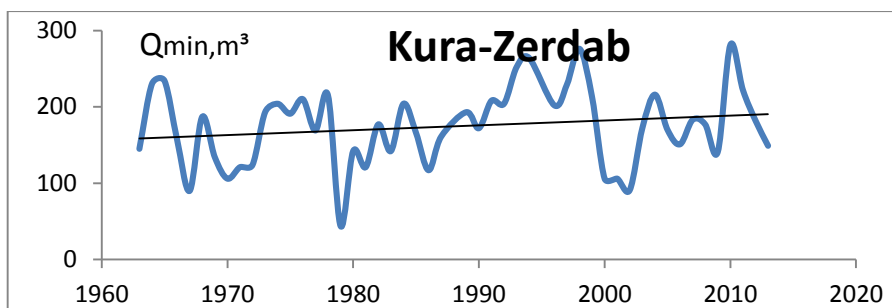


(a)



(b)





**Fig. 1. The change of maximal (a), average annual (b) and minimal (c) flow in rivers.**

I.e., there is mostly observed the increase of winter seasonal temperatures, which increases the role of the snow melt, and at the same time it embodies itself in the flow of the spring flood period (the duration of the flood period, the volume of the flow, maximal water discharge are decreased). Global climate changes on mostly influencing to the cryosp here, firstly, to the snow – ice cover of the continental and land territory result in serious destructions in their morphology structure [4, 5]. Continued, over 1986-2016 years the territories of Shahdaghglacier and Bazarduzu glacier respectively, have been decreased on 0.17 km<sup>2</sup> and 0.04 km<sup>2</sup>. The decrease processes, which are occurred in the general glaciers of the world, are observed over the main ice territory of Azerbaijan. So, over 1986-2016 year in the glacier territories the decrease processes has been. The comparative analysis of step expedition observations, held in Tufan dagh glaciers over 2011 – 2016 y.y. approves the decrease of glacier areas year by year. In 2016 the increase of the temperature has been consisted of 0.7 °C in comparison with multiyear norm. Most increase of the temperature has been observed on the latitudes of >1000 m (101°C). Except of October, November, December over other months temperatures have been higher than the, multiyear norm. In 9 and 19 January in Baku the average daily temperature has been higher than the climate norm on 10.1°C. In 5 February in Baku the maximal air temperature has consisted of 18.7°C, and so has refreshed the record indicator (15.5°C), which has been observed in 1944. In 25 March in Baku the maximal air temperature of the air has been higher than the climate norm on 10.0°C. 24 November the maximal air temperature in Baku has been consisted of -4.30 C of frost, and so, the record daily indicator of 1950 y. has been refreshed (-2.1°C).



2011



2012



2013



2014



2015



2016

**Fig.2. The comparative analysis of the condition of higher suspended glaciers over 2011-2016 y.y. period.**

The maximal speed of the wind (37m/s) has been observed in Dashkesenin August, in Absheron coastal region it has been 35 m/s. Over the year hail regions of the republic there have been hails in 12 days. Over the year over the territory of the country there have been observed to 20 floods. In Caspian Sea the maximal height of the wave has consisted of 5.9-7 m Neft Dashlary region. In 2016 y. in the sea the average annual level has consisted of 33 sm (Neft Dashlary region), so, firstly, over last years in the sea there has been noted the increases of the level on 1.0 sm. The maximal monthly level has been observed in July (57 sm) and the minimal in February (9 sm).

### **References**

1. Р.Н. Махмудов, В.А.Алиев, С.Г.Абдурагимов, Изоляция русла от поймы в нижней Куре и её последствия, Метеорология и Гидрология, 2015 №2, с.71-75.
2. Р.Н. Махмудов, Региональные климатические изменения и речной сток в Азербайджане, Метеорология и Гидрология, сентябрь, 2016 №9, с.63-69.
3. Р.Н. Махмудов, В.А. Алиев, С.Г. Абдурагимов, Морфометрические и антропогенные факторы риска наводнений в нижней Куре, Водные ресурсы, Том 44, №2, 2017, с.135 – 138.
4. R.N. Mahmudov, The hydrometeorological security of Caspian Sea and TRASECA, UNDERSTANDING the problems of inland waters: casestudy for the Caspian basin (UPSB), 12-14 May, Baku, 2018.
5. H.Bağirov, R.N.Mahmudov, Antarktida iqlimi, qlobal təsirlər, Ziya – Nurlan nəşriyyatı, Bakı, 2009, 227 s..
6. R.N.Mahmudov, Müasir iqlim dəyişmələri və təhlükəli hidrometeoroloji hadisələr, AHY, Milli Aviasiya Akademiyası, 2018, 231 s.

### **FACTS, INVESTIGATION AND CONTROL OF WATER QUALITY AND PUBLIC HEALTH**

**C.J. Blasi**

*International Academy of Science (Health&Ecology),  
Koblenz, Germany*

The aim of this paper is to give a general overview of water and health. Furthermore it enlightened which facts and discipline are involved by assessing and serving good quality water to public and industry. However there are still a problems,

especially in developing countries. A touch of the history of sanitation during from Roman Times over Middle Age to Modern Times gives an insight view what was achieved and what was lost. To manage all the problems with water and wastewater, a profound knowledge about the water itself, its occurrence in time and the required technology in drink water and wastewater treatment is necessary. Despite all these achievements, many people in developing countries suffer from water related diseases, especially in hot climate.

**Keywords:** *Solute Processes, Water Quality, History of Sanitation, Water-related Diseases*

## **Introduction**

Water is the most important natural resource in the world. Without water life cannot exist and many industries rely on water. Furthermore there is no substitute for water, and it plays a major and vital role in development of communities. It will be used directly, either consumption by man or for daily service in sanitation. Furthermore it plays a major role in various industrial processes, and with the help of hydro-electric barrages and dams it creates electrical energy.

Pump-storage schemes [1] yield in an efficient way both energy and storage of energy. Unfortunately, liquid and solid wastes from such communities have a considerable potential for environmental pollution. Therefore water as a natural resource has to be carefully managed, as growing populations and industrial developments demand and even increase supplies of water.

## **Historical Background**

Even in ancient civilization, the importance of water supply and sanitation provisions was well known. Archaeological investigation shows that latrines and drains were present in Neolithic dwellings. The Minoan civilization [2] in Crete 2000 years B.C. had clear water and flushing toilets in the houses. The Romans had highly developed water supply and drainage systems and their cities used large amounts of water. Huge buildings like aqueducts, e.g. Pont-du-Gard in southern France, pay still attention to the Romans' water supply. These aqueducts provided communities with good-quality water. Surface water and discharge from latrines were removed in stone sewers out of the cities. But with the fall of the Roman Empire many of these systems and construction declined, and for centuries water supply and sanitation systems disappeared. Most of today's cities were built on rivers during the Middle Ages, because

these rivers provided the water needed, and also served for waste disposal. In larger towns sewers were build, but only for removal of surface water. By this time sanitary provisions were usually very meager. It was common to discharge liquid and solid waste from windows into the streets. Therefore it is not surprising that life expectancy was less than half of the todays figure in the developed world. To improve these circumstances, large towns e.g. London passed a law in 1847 [3], too allow cesspit and latrine wastes to be discharge to the sewers. London's sewers drained into the Thames, from which much of the city's water was obtained. As the sewer system was not well maintained and in the best condition, a continuously leakage of waste water into the aquifer appeared. But water from aquifer was the second main water sources. The unavoidable consequences of this state of affairs, were that water sources became increasingly contaminated by sewage, waterborne diseases became uncontrollable in the city. The outbreak of cholera at the Broad Street Pump in 1854 caused 10.000 deaths. Dr. John Snow provided the information to demonstrate the link between sewage pollution of water and enteric diseases like cholera and typhoid.

The lost of 10.000 lives and public outcry, leads to the first public heath engineering works. Bazalgette, Joseph [4] was the chief engineer of London's metropolitan board, which was established in 1856. Ten years later nearly most of London was connected to a sewer network devised by Bazalgette. Therefore waterborne diseases were nearly under control in the UK by 1870. With the Industrial Revolution the demand of urban water increased, and construction of major water-supply schemes including huge upland impoundments were established too. Only the continual and careful attention of water quality control made it possible that waterborne diseases are almost eradicate in developed countries.

In the developing world the situation regarding water supply and sanitation are quiet different. During the last decades there was improvement in wastewater treatment and other facilities, but 2,4 billion people do not have access to improved sanitation facilities. Further more around 1 billion people worldwide still practice open defecation [5]. Estimation by UN 2017 figure out 842,000 deaths in middle- and low-income countries in the year 2012, which were caused by contaminated drinking water, inadequate hand-washing facilities, and inappropriate or inadequate sanitation services. Nevertheless, improved sanitation coveragedoes not necessarily equate with improved wastewater management or public safety. Only 26% of urban and 34% of rural sanitation and wastewater services effectively prevent human contact with excreta along the entire sanitation chain and can therefore be considered safely managed [5].

## Assessing the Quality of Water and Wastewater

Assessing the quality of water, is more than the evaluation of water for human consumption or industrial purpose. The whole pathway of water within the hydrological cycle have to be taken into account. Not only the water itself plays the major role, there are also the atmosphere, the soil, the sediments and the biota, who contribute to the quantity and quality of water. The sources of atmospheric solutes can be natural or anthropic one. Natural sources like inorganic particles are often present in the atmosphere. These are primarily blown sand from soil or in or near costal areas salt-particles from the sea. Organic particles are mainly pollen, which occurs at the time of high blossom. Combustion of fuel, reactions of gaseous pollutants within the atmosphere and sulphates and nitrates, which might be created by oxidation of SO<sub>2</sub> and NO<sub>2</sub> in the atmosphere or directly emitted as inorganic particles are the anthropogenic sources. As part of the hydrological cycle, the energy of the Sun's radiation causes water evaporation mainly from the oceans and produce water vapour, which is normal part of the Earth's atmosphere. It remains in the atmosphere until cooling and caused water droplets. They remain in the atmosphere too, and in sufficient quantity they occur as clouds. There is a quiet complicate process how clouds grow, and if they are large enough to fall as rain. These water precipitate over land areas takes several ways through the hydrological cycle. Some of these water will never reach the ground surface. It will be pick off by leaves of trees and plant until it evaporates. Water reaching the ground might fall on impermeable rock or even on paved areas. These water will either run off into natural or manmade drainage channels or it evaporates. Water which falls on soil might be evaporated, either directly or by transpiration from vegetation or via plant roots. It can also run over the soil-surface until reaching a ditch or stream, or it percolate into deeper layers of soils and might reach underlying rocks.

Most rocks consists of an assemblage of various minerals. To understand how rocks react with water, information about the minerals themselves and reaction with water is required. Sometimes the rocks are *monomineralic* e.g. limestones and *quartzites*. The batch of naturally occurring minerals is tremendous, but many are certainly not common rock-forming minerals. It is obviously, that different rocks have different minerals, and therefore the chemical reaction depend on it solely. Hydrogen ions, which is produced in soils are one of the most common source and plays a major role in weathering reaction. It can be stated that water travel through different soils and rocks is the agent of the various chemical reaction. As a result of these water with different chemical ions and other components. It comes very clear by comparing of *mineral waters* from different areas. The parameter to describe the quality of water are quiet

different in upland and lowland areas, and there is a variation in time. For example, the total amount of solids in upland is 50 mg/l, and in the lowland it is 400 mg/l. Therefore it can be stated that all waters either natural or reused contain different proportion of various matters. Natural rain might have only a few milligrams per liter, whereas sea water contain up to 35000 mg/l. Wastewater contains dissolved constituents, which arise from the water supply and from other pollutants during waste-producing processes. The human metabolism releases about 6 g of chloride each day. Therefore domestic sewage contain around 40 mg/l by 150 liter per person and day. It can be stated, that the release of 40 mg/l chloride per person and day is more than the chloride from the water supply. Raw sewage contains more or less 1000 mg/l of solids in solution and suspension. The remaining 99,9 per cent is just water. Seawater at 35000mg/l of impurities is apparently much more contaminated than raw sewage. On the other hand the measurement of total solids do not say anything about the character of the water. For example a clear sparkling groundwater can have for total solids than seawater [6]. For a true picture of the nature of a particular water, it is necessary to measure several different properties to assess the physical, chemical and biological characteristics. The characteristics are very different in its own. In the following paragraph a short description of nearly all parameters is given. For more detailed information the reader might refer to [7].

The *Physical Properties* do not need so sophisticated methods as chemical and biological issue. In many cases it is relatively easy to measure. *Temperature* is one of the basic information, it is important for chemical reaction and reduction in solubility of gases, etc. Depends on the environment of the water, the *Colour* is quite different. Therefore water from upland catchment shows natural yellow colour, due organic acids. If these waters treated by chlorination, trihalomethane are produced related to the humic substances. However, their might be potential hazard in lifetime consumption with concentration of a few  $\mu\text{g/l}$  of these substance.

But even pure water is not colourless, it is pale green-blue tint in large quantities. For consumption it should be clear and aesthetically. *Turbidity* occur when colloidal solids present in water is not so aesthetically, but may be harmful. Turbidity in water might come from clay and silt particles, sewage discharge to industrial wastes, or it might indicate large numbers of microorganisms. *Solids*, these may be present in suspension and/or in solution and they can be divided into organic matter and inorganic matter. Total dissolved solids (TDS) are due to soluble materials whereas suspended solids (SS) are discrete particles which can be measured by filtering a sample through a fine paper. The *Electrical Conductivity* depends on the quantity of dissolved salts present and for dilute solutions it is approximately proportional to the Total dissolved solids (TDS). The measurements of gross beta and gamma *Radioactivity* are routine quality checks. Radon is a naturally occurring radioactive gas, which rely on the particular

soils and rocks. Therefore it can be a possible long-term health hazard with some groundwaters.

The *Chemical Characteristics* or parameters are more useful in assessing the properties of a sample, because there are more specific in nature than physical parameters. Also there are quiet more chemical parameter than physical one. The following description can only give an overview of the chemical characteristic. The reader might be find more detailed answer in [7].

A water sample can be acid or alkaline, the intensity of such sample is measured on the *pH* scale. The value of pH indicates the concentration of hydrogen ions.

The *Oxidation-reduction potential* (ORP) measures the capacity of a solution to either release or accept electrons from chemical reactions. The ORP value, much like pH, is important for determining water quality and for water treatment processes.

*Alkalinity* is the capacity of water to resist changes in pH that would make the water more acidic. Alkalinity is useful in waters and wastes in that it provides buffering to resist changes in pH. It is normally divided into caustic alkalinity above pH 8.2 and total alkalinity above pH 4.5. *Acidity* is determined by measuring how much standard base must be added to raise the pH to a specified value. Acidity is a net effect of the presence of several constituents, including dissolved carbon dioxide, dissolved multivalent metal ions, strong mineral acids such as sulfuric, nitric, and hydrochloric acids, and weak organic acids such as acetic acid. Dissolved carbon dioxide is the main source of acidity in unpolluted waters.

Calcium and magnesium dissolved in water are the two most common minerals that creates the *Hardness* of water. The degree of hardness becomes greater as the calcium and magnesium content increases and is related to the concentration of multivalent cations dissolved in the water.

*Dissolved oxygen (DO)* is necessary to many forms of life including fish, invertebrates, bacteria and plants. These organisms use oxygen in respiration, similar to organisms on land. Fish and crustaceans obtain oxygen for respiration through their gills, while plant life and phytoplankton require dissolved oxygen for respiration when there is no light for photosynthesis. The amount of dissolved oxygen needed varies from creature to creature.

*Biological Oxygen Demand (BOD)*, is a measurement of the amount of dissolved oxygen (DO) that is used by aerobic microorganisms when decomposing organic matter in water. Biochemical Oxygen Demand is an important water quality parameter because it provides an index to assess the effect discharged wastewater will have on the receiving environment. BOD is also used extensively for wastewater treatment, as decomposition of organic waste by microorganisms is commonly used for treatment. Regulations for BOD will vary by country and region. In general, maximum allowable concentration



for direct environmental wastewater discharge fall around 10 mg/l BOD and maximum allowable concentrations for discharge to sewer systems around 300 mg/l BOD.

*Nitrogen* is essential for all living things as it is a component of protein. Nitrogen exists in the environment in many forms and changes forms as it moves through the nitrogen cycle. However, excessive concentrations of nitrate-nitrogen or nitrite-nitrogen in drinking water can be hazardous to health, especially for infants and pregnant women.

*Chlorides* are salts of hydrochloric acid or metals combined directly with chlorine. They are responsible for brackish taste in water and are an indicator of sewage pollution because of the chloride content of urine. The threshold level for chloride taste is 250-500mg/l, although up to 1500mg/l is unlikely to be harmful to healthy consumers who are accustomed to that concentration.

*Organic compounds* [8] are mostly from human activity or industrial operations. Substances which have been found include benzene, chlorophenols, oestrogens, pesticides, polynuclear aromatic hydrocarbons and trihalomethanes. Trihalomethanes are produced during disinfection of public water supply for long time [9]. All these compounds are normally present in very low concentrations, but there is some concern about possible health effects if such materials were consumed over a long time even at trace levels. When dealing with industrial wastewater or their effects on watercourses and aquatic life many other specialized chemical characteristics may be important, including heavy metals, cyanide, oils and greases.

The *Biological Characteristic* of water and its assessment is a topic of its own of great significance. There are living microorganisms in natural water, which play major roles in the aspects of water quality control. Many bacteria, viruses and protozoa are causative organisms for some of the more virulent diseases transmitted to humans directly through water. Assessment and confirmation of the presence of the causative agent of waterborne diseases are very tedious and time consuming. Coliform organisms have been used to determine the biological characteristics of natural waters. The coliform group of bacteria are aerobic and/or facultative gram-negative, nonspore-forming, rod-shaped bacteria that ferment lactose to gas. *Escherichia coli* is commonly used as an indicator organism. This organism is present in the intestine of warm-blooded animals, including humans. Therefore the presence of *Escherichia coli* in water samples indicates the presence of fecal matter and then the possible presence of pathogenic organisms of human origin. Raw sewage contains millions of bacteria per milliliter and many organic wastewater have large populations of bacteria, but the actual numbers are rarely determined. Conventional treatment methods for sewage and organic wastewater rely on the ability of microorganisms to stabilize organic matter so that very large numbers of microorganisms are found in wastewater treatment plants and in their effluents. Microorganisms can thus play valuable roles in wastewater treatment and

sometimes also in water treatment, but they are usually considered as sources of potential nuisance and hazard in relation to drinking water.

### **The Role of Scientists and Engineers**

It can be stated, that water science and technology is an interdisciplinary issue involving application of biological, chemical and physical principles in connection with engineering topics. Civil Engineers have always been great activities in planning and building of water supply and sewer systems, and wastewater treatment plants.

Public health engineering is probably one of the largest part of civil engineering profession. Together with scientific colleagues they have a profound association in reducing the incidence of various water-related diseases. The work and the responsibilities of engineer starts with development of water sources. The sources have to provide continuous comfortable supply of water of healthy quality and free from:

- visible suspended matter,
- excessive colour,
- taste and odour,
- objectionable dissolved matter,
- aggressive constituents,
- bacteria indicative of faecal pollution.

The water sources can be every kind of water like a natural lake, a river or groundwater. All these sources are play an important role within hydrological cycle. These cycle also include all water on earth. There is a huge amount of water present in the earth and its atmosphere. Around seven per cent of the earth's mass is made up of water. Nevertheless, 97 per cent of all water appears as saline water in oceans. Most of the remaining three per cent is freshwater, and trapped in the polar ice. Only 0.7 per cent of all earth's water occurs in lakes, rivers, aquifers and in the atmosphere. However, if the water were evenly distributed on the surface of the earth and if the world population were similarly distributed there would be no lack or shortage of water.

Unfortunately the spatial distribution of rainfall is not even and crowded urban areas consume large amounts of water, consequently shortage of water occur. Hydrology, which is the science of management of the hydrological cycle and its water resources is another important part in the increasing demands of water throughout the developing world. It must therefore appreciated that in considerations of water resources it is essential to assess both the quality and quantity of the source. If the water source

for a city or community fulfill all the above mentioned constrains, then the water must be delivered to the consumers via a complex distribution system.

Depends on the quality of water, sometimes it must be treated with various technology. Industrial and domestic user of water usually produce deterioration in quality, therefore the wastewater must be collected and given effective treatment before release to the environment. Sometime treated wastewater plays significant part of the water resource and are available for reuse. Water reuse take place in a wide range of application, like agriculture or gray water. But these application needs further advanced monitoring and management.

### **Water Quality and Health**

As mentioned above that water is essential for human life and development, it also can, if contaminated, great potential for transmitting various diseases and illness. Due too the water supply and wastewater disposal systems in the developed world, water related diseases are very seldom or rare. However, in the developed world, there is concern about the possible long-term health hazards that may arise from the presence of trace concentrations of impurities in drinking water, with particular attention being paid to potentially carcinogenic compounds. There are several other chemical contaminants, which may be naturally occurring or man-made, that have known effects on the health of consumers. It is therefore important that the relationships between water quality and health be fully appreciated by the engineers and scientists concerned with water quality control. In 2002 approximately 1.3 billion people are without proper water supply and almost 2.6 billion do not have adequate sanitation facilities, which 42 per cent of the world's population. As a result, the figure of water-related disease in these areas is frightening in its extent. Millions of people die each year as the consequence of unsafe water or inadequate sanitation and although exact information is difficult to obtain. Everydiseases require for their spread a source of infection, a transmission route, and the exposure of a susceptible living organism.

Control of disease is thus based on curing sufferers, breaking the transmission route and protecting the susceptible population. Therefore diseases control can be measured in different ways either via engineering by breaking the transmission route and by medical measurement. Bradley in [10] described about two dozen infectious diseases, which are driven by water. These diseases may be due to viruses, bacteria, protozoa or worms and although their control and detection is based in part on the nature of the causative agent it is often more helpful to consider the water-related aspects of the spread of infection.

There are different ways of infection with Water-related diseases:

- *Waterborne diseases,*
- *Water-washed diseases,*
- *Water-based diseases,*
- *Water-related insect vectors.*

*Waterborne diseases* are spread by contamination of water by human faeces or urine, and it is the commonest form of these diseases. The infection occurs when a pathogenic organism gains access to water which is then consumed by a person who does not have immunity to the diseases. Contaminated water can cause many types of diarrheal diseases like cholera, typhoid, bacillary dysentery, etc. It is estimated that these diseases cause 4 million deaths each year. It should be mentioned that although these diseases can be waterborne they can also be spread by any other route which permits direct ingestion of faecal matter from a person suffering from that disease. Poor personal hygiene of workers in food handling and preparation would provide an obvious infection route. Poor personal hygiene of workers in food handling and preparation would provide an obvious infection route. The situation is further complicated in that some people may be carriers of diseases like typhoid so that although they exhibit no outward signs of the disease their excreta contain the pathogens. Weil's disease (leptospirosis) is transmitted in the urine of infected rats and the causative organism is able to penetrate the skin so that external contact with contaminated sewage or flood water can spread the disease. Workers in sewage systems have to be screened constantly.

*Water-washed diseases* are infections that are caused by poor personal hygiene resulting from inadequate water availability. These malady may be prevented if people have acceptable supplies of drinking water for hygiene. These include a number of skin and eye infections which, whilst not normally fatal, have a serious debilitating effect on sufferers. The diseases of this type include bacterial ulcers and scabies, and trachoma. Scabies is easily transferred through person-to-person contact and some 300 million people contract the disease each year. Trachoma is a bacterial eye infection that begins as conjunctivitis, but if left untreated can cause blindness. Trachoma spreads through direct contact and is most common in communities without proper sanitation facilities. More than six million people worldwide may be blind because of this disease, and some 150 million more await treatment. All these diseases tend to be associated with hot dry climates and their incidence can be significantly reduced if plenty of water is available for personal washing.

*Water-based diseases* are caused by aquatic organisms that spend part of their life cycle in the water and another part as parasite of animals. These diseases are caused by worms which infest the sufferer and produce eggs which are discharged in faeces or urine. Infection often occurs by penetration of the skin rather than by consumption of the water. Schistosomiasis (also called bilharzia) is probably the most important

example of this class of disease. The transmission way of schistosomiasis is quite complex. If a sufferer excretes into water, eggs from the worms hatch into larvae which can live for only 24 h unless they find a particular species of snail which acts as an intermediate host. The larvae then develop in a cyst in the snail's liver which, after about six weeks, bursts and releases minute free-swimming cercariae which can live in water for about 48 h. The cercariae is able to puncture the skin of humans and other animals and they can then migrate through the body via skin, veins, lungs, arteries and liver in a period of around eight weeks. The parasite then develops in the veins of the wall of the bladder, or of the intestine, into a worm which may live several years and which will discharge enormous numbers of eggs. Schistosomiasis is often spread by irrigation schemes and stagnant water behind dams. Therefore it tends to provide suitable environment for the snail host as well as increasing the likelihood of contact with the water by agricultural workers.

Another water-based disease which is widespread in the tropics is Dracunculiasis (guinea worm). The intermediate host is cyclops, which is a small crustacean. The infection occurs by ingestion of water containing infected cyclops. The eggs are discharged when an ulcer on the skin of a sufferer bursts and they can remain viable in water for one or two weeks. If eggs are ingested by cyclops they develop into larval forms in a further two weeks. The larvae leave the ingested cyclops during human digestive processes and migrate through the tissues to the lower limbs of the body and eggs are discharged about nine months later. The vector species of cyclopsis prevalent in stagnant water with some organic content. Control of guinea worm, which can bring marked improvements in the health of the population, is essentially based on protection of water sources, particularly springs and wells. The provision of sloping hardstandings and small walls round water sources will effectively prevent the access of eggs to the water.

*Water-related insect vector* which means, there are insects which breed or feed near water so that their occurrence can be related to the closeness of suitable water sources. The infection of such diseases is in no way related with human consumption of water, or contact with water. Insects like mosquitoes, which transmit malaria and many other diseases, prefer shallow stagnant water in pools, around the edges of lakes and in water storage jars. It is therefore important to ensure that water supply and drainage works do not provide suitable mosquito habitats. Unfortunately these are not always possible. Therefore, mosquitoes should be prevented from gaining access by the provision of effective screens. Simulium flies, which transmit onchocerciasis (river blindness), breed in turbulent waters associated with rapids, waterfalls, etc., or created by engineering structures like weirs, energy dissipators, etc. Control is usually by use of insecticides injected upstream of the point of turbulence.

All these water-related diseases are most common in developing countries with hot climate and inadequate water supply and sanitation, and enormous hazards to public health in large areas in the world. However, there are also water-related diseases in the developed world.

For example the outbreaks of Legionnaires' disease, which has a strong evidence to the presence of *Legionellapneumophila* in domestic hot water supplies, shower heads, cooling waters and other aquatic systems which produce droplets or fine sprays. As a result of the solvent properties of water many substances may be found in solution in natural waters and some of them are potentially hazardous to human life. In most cases the concentrations of most potentially harmful impurities in natural waters are normally very low but there are thousands of compounds used in agriculture, in the home and in industry which can find their way into surface. The description of all these chemical compounds, from source, occurrence, chemical reaction to other parameters, and the treatment in water supply and wastewater treatment are tremendous and a chapter of its own and out side the scope of this paper.

### **Conclusion**

Providing the public and the industry with adequate water is a business of its own in the developed world. Many processes and different subjects are involved, until the water flow to the tap of the public and of the industry. Hydrologists are involved by finding competent sources of water, either surface or groundwater, civil engineer design, plan, and work on the distribution of the water system, and the wastewater collection system including the treatment plant. Staff in the laboratories monitoring constantly the quality of drinking water. Chemists, Biologists and Medical Doctors define standards of water quality and its threshold levels. In addition to these management and monitoring of water and wastewater special devices and procedures are developed by water authorities and private companies. For example, laboratory equipment and special hard and software for analyzing has been developed. All these work well in the developed world. However, advanced investigation and research are necessary to face the mechanism of solute processes in unsaturated and saturated zone during the whole soil matrix and groundwater in the light of artificial components.

But, by facing the water and health problems in the developing world, an another approach is necessary. Good quality technics in water supply like hard surface with a mild slop around a water pump is very helpful in avoiding contamination of drinking water. Furthermore robust and proper wastewater collection system should prevent for infection. With the help of engineer solution stagnant water, which provide condition for unpleasant breeding of mosquitos can be avoided. It can be stated, a lot of *water related diseases* can be controlled via the transmission route water. Furthermore education and teaching should go hand in hand.

### **References**

1. Gimeno-Gutiérrez, M.: Assessment of the European potential for pumped hydropower energy storage -A GIS-based assessment of pumped hydropower storage potential, Scientific and Policy Report by the Joint Research Centre of the European Commission, 2013
2. Garbrecht, G.: Wasser, Vorrat, Bedarf, und Nutzung in Geschichte und Gegenwart, p. 118-151, Rowohlt Taschenbuch Verlag, Hamburg 1985
3. Feachem, R. G.: Water, Wastes and Health in Hot Climates. Wiley. Chichester, 1977.

4. Bazalgette, J.,  
[http://www.bbc.co.uk/history/historic\\_figures/bazalgette\\_joseph.shtml](http://www.bbc.co.uk/history/historic_figures/bazalgette_joseph.shtml), download 20.02.2018
5. The United Nations World Water Development Report 2017, EXECUTIVE Summary, United Nations World Water Assessment Programme Programme Office for Global Water Assessment Division of Water Sciences, UNESCO 06134 Colombella, Perugia, Italy
6. Price, M. 1985.: *Introducing Groundwater*. George Allen & Unwin, Publisher Ltd., London, 1985
7. Sawyer, C. N. et al.: *Chemistry for Environmental Engineering and Science* 5th Edition, McGraw-Hill, 2003
8. Greeson, P. E., Ed.: *Organic Substances in Water, Briefing Papers on Water Quality*, US Geological Survey, 1981
9. *Drinking Water and Health*. Safe Drinking Water Committee, National Academy of Sciences, Washington, D.C. 939 pp., National Academy of Sciences. 1977
10. Bradley, D. J.: *Health aspects of water supplies in tropical countries*. In *Water, Wastes and Health in Hot Climates* Chichester: Wiley, 1977

## **GRAVITATIONAL PRECURSORS BEFORE SOME MEGA EARTHQUAKES**

**<sup>1</sup>Elchin Khalilov, <sup>2</sup>Lanmin Wang, <sup>3</sup>Lala Khalilova**

*<sup>1</sup>Global Network for the Forecasting of Earthquakes,  
Baku, Azerbaijan, e-mail: [prof.khalilov@gmail.com](mailto:prof.khalilov@gmail.com)*

*<sup>2</sup>Lanzhou Institute of Seismology, China Earthquake Administration,  
e-mail: [wanglm@gsdzj.gov.cn](mailto:wanglm@gsdzj.gov.cn)*

*<sup>3</sup>Azerbaijan State Oil and Industry University, Baku, Azerbaijan  
e-mail: [lala\\_khalilova@mail.ru](mailto:lala_khalilova@mail.ru)*

**Abstract.** *The authors consider the gravitational precursors of Mega Earthquakes in Asia and Southeast Asia: Sichuan earthquake, M7.9, May 12, 2008; Andaman Islands earthquake, M7.5, August 10, 2009; Samoa Islands earthquake, M8.1, September 29, 2009; Northern Sumatra earthquake, M7.8, April 06, 2010; Tohoku earthquake, M9, March 11, 2011. All gravitational precursors were recorded using of ATROPATENA earthquake prediction stations. The creation of an international earthquake prediction system based on the results obtained is proposed.*

**Keywords:** earthquake forecasting; earthquake prediction; gravitational precursors; tectonic waves; ATROPATENA station; seismology; geodynamics; geotectonics.

## **Introduction**

During the whole history of humanity the people have been trying to learn the possible natural cataclysms beforehand. It is mentioned in ancient historical sources, legends, myths and in religious writings. For this purpose they used all accessible for them opportunities in accordance with their level of knowledge and philosophy. They tried to use astronomical phenomena and they associated the natural cataclysms with them. For example, ancient people take the solar eclipses, approaches of the Mars to the Earth, appearance of spots on the Sun, unusual behavior of animals and unusual phenomena in atmosphere as special signs of approaching of the catastrophe. How far have the modern scientists gone from their predecessors? If we try to make parallels, we'll see that the modern science with more interest studies the influence of planets of solar system, solar activity and other cosmic factors on seismicity and volcanism. Meanwhile, for short-term forecasting the earthquakes are also used (as earlier) the different precursors of earthquakes. The main difference is in explanations of the mechanism of connection between the observed precursors and the process of preparation of the earthquake. Another main difference is the application of modern recording equipment, which use high tech. In other respects "philosophy" of forecasting the earthquakes practically hasn't been changed.

### **Short-Term Forecasting of Earthquakes: Pros And Cons**

The scientific researches, aimed at creation of effective technology of forecasting the earthquakes were financed about 100 years in many developed countries of the world. Disappointment of public officers and wide mass of the population because of absence of serious achievements in this sphere can be understood. Seismologists, who forecast the earthquakes and spent milliards of dollars in the whole world, found themselves in difficult and delicate situation. Most of them were looking for justifications of their scientific failures, and gladly found them during international scientific meeting which was called in London on 7-8 November 1996 on the subject of interrelation of earthquakes with other phenomena in order to forecast them. Transactions of this meeting were published in [3]. During this authoritative forum the famous seismologist Dr. Robert J. Geller declared the impossibility in principle of forecasting the earthquakes. His main idea is that the process of preparation of the earthquake source has a big probability of randomness and influence of many external factors. That is why he considers this process as a maximally approximate to chaotic processes. Many further articles and speeches of Dr. Robert Geller were the continuation of his idea about impossibility of forecasting the earthquakes. This idea is reflected in his basic statement: "Research in the sphere of forecasting the earthquakes have been carrying out more than 100 years without evident success. The results of researches didn't allow to receive the great achievements. The extensive researching was not able to



find reliable precursors. Our theoretic work supposes, that break displacement is nonlinear process, which is very sensitive to unknown details of structure of the Earth in bulk, and not only in immediate proximity to the epicenter. The reliable accordance of alarms about unavoidable strong earthquakes is inefficient and impossible" [4]. Registration of different precursors in big distances from epicenters. Now there is known more than 300 precursors of earthquakes of different character and origin. During the last years a number of scientists published the results of researches, indicative of possibility of registration of strong earthquakes precursors in the distance of more than 5000 km, and in some cases more than 10 000 km [6,8,9,14,17- 19].

### **Classification of the considered "long-range" precursors**

So, the carried out brief review allowed to mark out a few precursors of earthquakes, which appear in big distances between registering points and epicenters of earthquakes:

- Seismic-gravitational anomalies [18];
- Tideless variations of gravity [8];
- Changes of hydro-geo-chemical mode [6];
- Changes of the level of ground waters [16];
- Synchronization of micro-seismic noise [17,19];
- Long-period three-dimensional variations of gravitational field [9].

We didn't review some other precursors, which also display in big remoteness from epicenters of strong earthquakes (variations of different parameters of ionosphere, electromagnetic noise disturbances, electric, magnetic and other precursors).

### **Methodology**

A new instrument for experimental study of the space-time variations of measured values of  $G$  was created, called the ATROPATENA detector /Khalilov E.N., PCT patent, 2013, [10]. The ATROPATENA station measures the  $\Delta G$  index which is the difference between the gravitational constant  $G$  (initially measured  $G$  value) and measured values of the Cavendish balance at the measurement time  $-G_F$ :

$$\Delta G = G - G_F \quad (1)$$

The ATROPATENA-AZ station (Baku, Azerbaijan) was used to register gravity anomalies before strong earthquakes, namely in Japan on 7 May 2008 and Sichuan, China on 07, 12, 13 and 17 May 2008 and other earthquakes [9, 12, 13]. Since only relative changes of the gravitational field reflecting deviations from the initially measured  $G$  value are important for researchers, a conventional index of variations of the gravitational field  $\Delta G$  was taken as a basis for registration and subsequent analysis. To convert the  $\Delta G$  index into a gravitational constant  $G$  measuring unit, the recorded  $\Delta G$  index should be accepted at the first approximation as the  $G$  value starting from the second digit after the decimal point. According to CODATA [1] as of April 2011, the value of the gravitational constant  $G$  is

$6.674\ 28 \times 10^{-11} \text{ m}^3 \text{ kg}^{-1} \text{ s}^{-2}$ , standard uncertainty  $0.00067 \times 10^{-11} \text{ m}^3 \text{ kg}^{-1} \text{ s}^{-2}$ , relative standard uncertainty  $1.0 \times 10^{-4}$ , concise form  $6.674\ 28(67) \times 10^{-11} \text{ m}^3 \text{ kg}^{-1} \text{ s}^{-2}$ . So, only two digits after the decimal point remain unchanged in the measured value of the gravitational constant  $G$ ; from the third digit on, the ATROPATENA stations register periodical spatio-temporal variations that depend on the location of the recording device and its spatial orientation:

$$G_F = 6.67(\pm\Delta G) \times 10^{-11} \text{ m}^3 \text{ kg s}^{-2}(2)$$

Where  $G_F$  is the actually measured value of the gravitational constant at the measurement time. Researches have found that  $\Delta G$  records obtained using the mutually perpendicular Cavendish balance are not always synchronized and often lack a pronounced correlation [9]. This fact can also be observed from the records of all the stations before and after the disastrous Japanese earthquake of March 11, 2011. Along with measuring  $AG$ , the ATROPATENA stations simultaneously register variations in time of relative values of gravity  $A_g$ , using a microgravimeter installed inside the vacuum tank.  $\Delta g$  values are also measured in arbitrary units to facilitate research. If necessary, the measured  $A_g$  values can be converted to  $mGal$ . Among the participant of the experiments and their analysis were organizations - Global Network for the Forecasting of Earthquakes (GNFE, London, UK, [www.seismonet.com](http://www.seismonet.com)), Scientific Research Institute for the Forecasting and Studying of Earthquakes (Baku, Azerbaijan) and Lanzhou Institute of Seismology (Lanzhou, Gansu, China).

### Measurement Results

From 2008 to 2013 the "ATROPATENA" earthquake forecasting stations of the Global Network for the Forecasting the Earthquakes (GNFE) recorded the gravitational precursors of earthquakes before all major earthquakes in Europe, Asia and Southeast Asia. Let us consider the most interesting and characteristic records of gravitational precursors of earthquakes and gravitational effects before, during and after strong earthquakes that were registered by ATROPATENA-ID stations (located in Yogyakarta, Indonesia) and ATROPATENA-AZ (located in Baku, Azerbaijan). Hereinafter we will call the records of ATROPATENA stations "the gravitograms". Let us consider the gravitogram records for the following strong earthquakes: 1. Tohoku, March 11, 2011, M9.0; 2. Sumatra, April 06, M7.8, 2010; 3. Samoa, September 29, 2009, M8.1; 4. Andaman, August 10, 2009, M7.5; 5. Sichuan, May 12, 2008, M7.9.

#### A. *The analysis of the gravitogram of earthquake Tohoku, March 11, 2011, M9.0*

We have considered the recording of the gravitogram of the earthquake in Tohoku, March 11, 2011, M9.0 (Fig.2., I and A) made by the ATROPATENA-ID station. The distance between the epicenter and the ATROPATENA-ID station was 5.950 km.

Earthquakes parameters in Japan from 09 to 22 March 2011

Table 1

No.	<i>Date, time</i>	<u>Location</u>	<u>Depth</u>	<i>Magnitu de</i>
1	March 09, 2011	38.440°N,	32 km	7.3
	Time:02:45:20 UTC	142.840°E		
2	March 11, 2011	38.297°N,	30 km	9.0
	Time: 05:46:24 UTC	142.372°E		
3	March 11, 2011	36.281°N,	42 km	7.9
	Time: 06:15:40 UTC	141.111°E		
4	March 22, 2011	37.249°N,	26.5 km	6.6
	Time: 07:18:47 UTC	143.956°E		

Table 1 shows the parameters of a strong earthquake in Tohoku, as well as foreshocks and aftershocks. Fig. 2 shows maps of the epicentral zones of the earthquakes under consideration (I-V) and gravitograms of these earthquakes (A; B; C; D; E). It should be noted that the gravitograms A; B; C; D have been recorded by the ATROPATENA- ID station, and the gravitogram E have been recorded by the ATROPATENA-AZ station. On the gravitogram (Fig. 2, A) it is clear that before the indicated series of earthquakes three gravitational anomalies were registered - 1, 2, 3: the first and second - on March 7 at 17:15 and at 21:57; the third anomaly - on March 8 at 11:36.

Then, the  $\Delta G$  value is reduced by 55 units and remains unchanged until March 12, 20:33, after which it is increased by 60 units. Thus, approximately 15 hours after the moment of decreasing of  $\Delta G$ , there occurs a strong foreshock on March 09, 2011 at 02: 45UTC. Then on March 11, 2011 at 05: 46 UTC there occurs a strong earthquake with M9.0 and 29 minutes later the second strong earthquake (aftershock) with M7.9 occurs. The last strong aftershock occurs on March 22, 2011 at 07:18UTC. Thus, if we do not consider the weak foreshocks and aftershocks, four strong tremors occur in the epicentral zone.

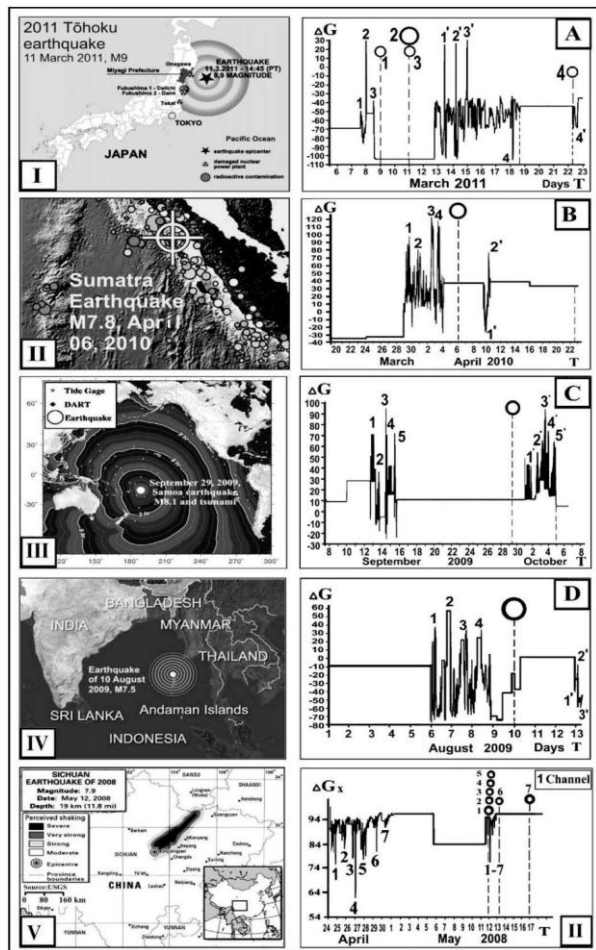


Fig.2. I, II, III, IV, V - Maps of the epicentral zone of the earthquakes in: Tohoku, March 11, 2011, M9.0; Sumatra, April 06, 2010, M7.8; Samoa, September 29, 2009, M8.1; Andaman, August 10, 2009, M7.5; Sichuan, May 12, 2008, M7.9. A, B, C, D - recording of gravitogram of ATROPATENA-ID (in Indonesia) station before, during and after earthquakes: Tohoku; Sumatra; Samoa; Andaman and E - recording of gravitograms of ATROPATENA-AZ (in Azerbaijan) station before, during and after Sichuan earthquake.  $\Delta G$  - index which is the difference between the gravitational constant  $G$  (initially measured  $G$  value) and measured values of the Cavendish balance. The  $\Delta G$ -index values correspond to the value  $G$  starting from the third decimal place; 1, 2, 3... - numbers of gravitational precursors; 1', 2', 3' - secondary gravitational anomalies;  $\bigcirc$  1, 2, 3... - moments of earthquakes.

Meanwhile, as it can be seen on the gravitogram, the gravitational anomalies of 1, 2, 3 were recorded before first three earthquakes. Then we see a decrease in the value and a straight line from 08 to 12 March, after which three nearby anomalies were registered again: 1', 2' and 3'. Thus, we can assume that the anomalies 1, 2, 3 are the precursors of earthquakes, and the anomalies 1', 2' and 3' are secondary and were formed as a result of the release of powerful tectonic energy from three strong earthquakes. Between the primary and secondary anomalies, a straight line has been registered, which persists for four days. On March 18, another very intense gravitational anomaly 4 is recorded, after which the value of  $\Delta G$  is increased by 60 units and remains unchanged until March 22. At the moment of the end of the straight line and the beginning of the next gravitational anomaly, the fourth strong shock takes place, after which, about five hours later, an intense negative anomaly 4' was recorded. Thus, gravitational anomaly 4 is a precursor of earthquake 4, and gravitational anomaly 4' is a secondary anomaly from earthquake 4. We see that again between the primary and secondary anomalies a straight line is registered, which persists for four days.

### ***B. Analysis of the gravitogram of the earthquake Sumatra, April 06, 2010.***

The recordings of gravitogram before, during and after Sumatra earthquake was done by the ATROPATENA-ID station, fig.2., II and B. The record shows that a straight line was recorded from March 19 to March 29, and since March 29 the station had registered an increase of  $\Delta G$  by 135 units, after which four intense impulses are registered - 1-4 until 04 March, then again a direct line is observed until March 09, 22 : 32. Then, on April 10, we observe a sharp negative impulse  $\Delta G$  with a decrease by 65 units after which  $\Delta G$  is restored to its previous level and immediately afterwards a positive impulse was registered with an increase of  $\Delta G$  by 40 units. Then the value returns to its previous position and from April 10 a direct line is registered again until the end of observations on April 23, 2010. A strong earthquake M7.8 occurred on April 06 during the recording of a straight line. Thus, we believe that gravitational anomalous impulses 1-4 are the precursors of the strong Sumatra earthquake, and we take the most intense impulse 3 as the precursor of the main shock, and the  $\Delta G$  impulses - 1,2 and 4 are precursors of two foreshocks and aftershock. At the same time, the impulses 1' and 2' are secondary impulses. As in the previous case, a straight line is recorded between gravitational precursors of earthquake and secondary impulses within 5 days.

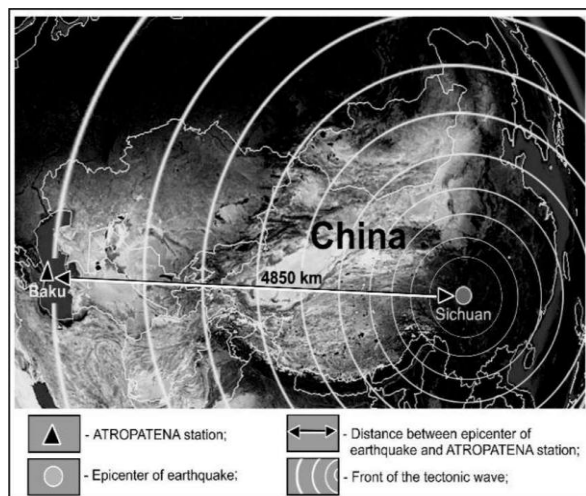
### ***C. Analysis of gravitogram of the earthquake Samoa, September 29, 2009, M8.1***

The recording of gravitograms before, during and after Samoa earthquake was done by the ATROPATENA-ID station, fig.2., III and C. The record shows that from September 7 to September 10, 2009 a direct line was recorded and starting from September 10 the station registered an increase of  $\Delta G$  by 20 units, after which a direct line is registered again until September 12, 17:30, after which five intensive anomalies  $\Delta G$  fig. 2, C, 1-5 were registered. Beginning from September 15, 22:17, a direct line is registered until October 1, 2009. Meanwhile, on September 29, there occur a strong earthquake with M8.1, after which since October, 1 five anomalous impulses  $\Delta G$ -1'-5' are successively recorded. We see that, in amplitude the impulses 1-5 roughly correspond to the impulses 1'-5', while impulses 3 and 3' are the most intense and have the same amplitude of about 85 units. In our opinion, impulse 3 is a precursor of an earthquake, and the impulse 3' is a secondary impulse as a result of the isolation of tectonic energy during the earthquake. In this case, impulses 1, 2, 4 and 5 are precursors of two foreshocks and two aftershocks, and the impulses 1', 2', 4' and 5' are secondary impulses release of two foreshocks and two aftershocks. As in the previous gravitogram records, we had been observing a direct line between the primary and secondary impulses  $\Delta G$  for 15 days. Then the value of  $\Delta G$  again increased by 50 units and remained unchanged from 10 to 13 August, after which two intense negative impulses  $\Delta G$  were recorded, the latter with a decrease by 72 units.

### ***Analysis of the gravitogram of the earthquake Andaman, August 10, 2009, M7.5***

The gravitogram recording before, during and after Andaman earthquake was done by the ATROPATENA-ID station, fig.2, IV and D. The record shows that from 01 to 06 August 2009 a direct line was recorded, and starting from August 6 the station registered four intensive anomalies  $\Delta G$  (fig.2, D, 1-4). On August 08 at 21:37 the  $\Delta G$  value was reduced by

65 units and remained at this level with minor variations until August 9, 10:32, after which it rises by 35 units. On August 09, from 22:05 to 00:00 the  $\Delta G$  impulse was registered with an increase in the level by 23 units, after which the value returned to its previous position. During this impulse, a strong earthquake occurs on August 10 with M7.5. Thus, we assume that the most intense anomaly 2 on fig.2. D, is the precursor of the main shock. Anomalies 1, 3 and 4 are precursors of weak foreshocks and aftershocks. Anomalies 1' and 2'  $\Delta G$  on fig.2. D are secondary and appeared as a result of the released tectonic energy during the earthquake and aftershock. As in the previous cases, the direct line was registered between the primary and secondary anomalies from 10 to 13 August too.



***Analysis of gravitogram of the Sichuan earthquake, May 12, 2008, M7.9***

Recording the gravitograms before, during and after the Sichuan earthquake was done by the ATROPATENA-AZ station (located in Baku, Azerbaijan), fig. 3. The distance between the epicenter and the ATROPATENA-AZ station is 4850 km.

**Fig.3. Map of the distribution of tectonic waves in the region of research.**

Table 2 shows the parameters of a strong earthquake in Sichuan, as well as previous and subsequent shocks. Since April 25, 2008, ATROPATENA-AZ stations have registered three-dimensional gravitational anomalies -  $\Delta G_x$  and  $\Delta G_y$  indexes which is the difference between the gravitational constant  $G$  (initially measured  $G$  value) and measured values of the Cavendish balance at the measurement time -  $G_F$  in two mutually perpendicular directions ( $\Delta g$  - variations of the relative values of gravity (the values after the decimal point are shown mGal). Analysis of the first channel of gravitogram on fig.1. of the Sichuan earthquake shows that since April 24, 2008 to April 30, 2008, seven intense gravity anomalies - the  $\Delta G_x$  index, have been recorded.

***1) Analysis of the gravitogram of the first channel.***

In the subsequent period from 01.05.2008 till 05.05.2008 there are no anomalies and starting from 05.05.2008 the values of the  $\Delta G_x$  index are reduced by 10 conventional units and remain unchanged up to 12.05.2008, after which the value of the index increases to the previous value. At the time of index recovery, one strong earthquake occurs: with M7.9 in Sichuan, China on May 12, 2008 (time 06:28:01) and four strong aftershocks (N°2-5 in table 2). Then two more strong earthquakes occur in this epicentral zone: with M5.8, 13

**Earthquakes parameters in Sichuan**

**Table 2.**

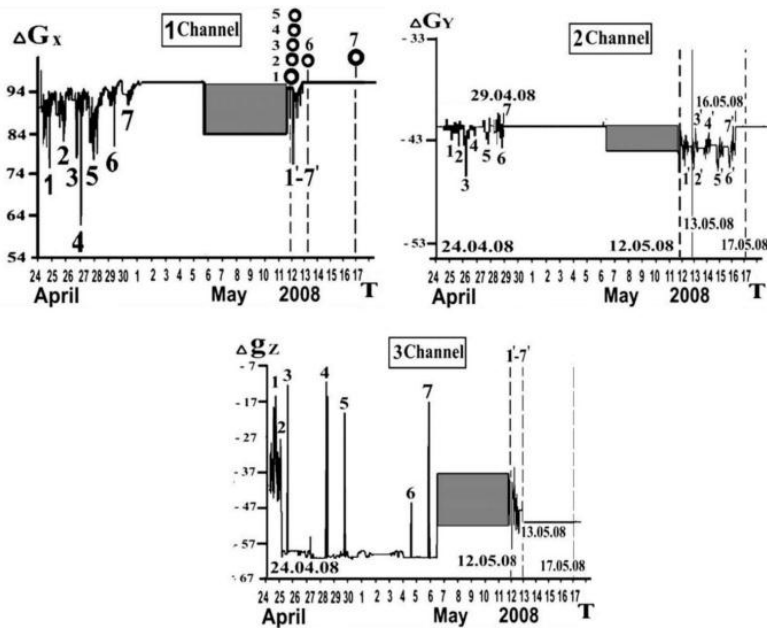
No.	<i>Date, time</i>	<i>Location</i>	<i>Depth</i>	<i>Magnitude</i>
1	May 12, 2008, Time:06:28:01,UTC	31.002°N, 103.322°E	19.0 km	7.9
2	May 12, 2008, Time:06:41:56,UTC	31.586°N 104.032°E	10.0 km	5.7
3	May 12, 2008, Time:06:42:08 U TC	31.342°N 104.682°E	10.0 km	5.7
4	May 12, 2008, Time:06:43:14,UTC	31.211°N 103.715°E	10.0 km	5.8
5	May 12, 2008, Time:11:11:02, UTC	31.214°N 103.618°E	10.0 km	6.1
6	May 13, 2008 Time: 07:07:08 UTC	30.890°N 103.194°E	9.0 km	5.8
7	May 17, 2008, Time:17:08:25, UTC	32.240°N, 104.982°E	9.0 km	5.8

May 2008 and with M5.8, 17 May 2008. From 12 to 13 May can see seven minor secondary anomalys on the gravitogram (1'-7'). Also, between the primary and secondary anomalies, we observe two straight lines, which persist from 01.05 to 05.05 and from 05 to 12 May 2008.

**2) Analysis of the gravitogram of the second channel**

**3)**

Analysis of the records of the second channel shows that from April 24, 2008 to April 29, 2008, six gravity anomalies were recorded - the  $\Delta G_y$  index, with a smaller amplitude, compared to the recording of the first channel. These anomalies are precursors of the Sichuan earthquakes. In the subsequent period till 08.05.2008 there are no anomalies and starting from 06.05.2008 the values of the  $\Delta G_y$  index decrease by 3 conventional units and remain unchanged up to 12.05.2008, after which the index value increases by 2 conventional units and we observe seven secondary anomalies in the period from 12.05.08 to 16.05.08. The authors consider that these anomalies are not precursors of earthquakes, but they are secondary ones and occur as a result of the release of powerful tectonic energy at strong earthquakes and aftershocks. At the moment of index  $\Delta G_y$  recovery one strong earthquake occur: with M7.9 in Sichuan, China on May 12, 2008 (time 06:28:01) and four strong aftershocks (N°2-5 in table 2). Then two more strong earthquakes occur in this epicentral zone: with M5.8, 13 May 2008 and with M5.8, 17 May 2008. From 12 to 13 May can see seven minor secondary anomalys on the gravitogram (1'-7'). As it can be seen on the recording of the second channel, from 12 to 17 May, the authors identified seven gravitational anomalies. According to the authors, these anomalies are the result of strong earthquakes and aftershocks, which occurred in the epicentral zone of Sichuan earthquake during this period of time.



**Fig. 4. 1 channel, 2 channel and 3channel - records of the first, second and third channels of the ATROPATENA station;  $\Delta G_x$  and  $\Delta G_y$  - indexes which is the difference between the gravitational constant  $G$  (initially measured  $G$  value) and measured values of the Cavendish balance at the measurement time -  $G_{Fin}$  in two mutually perpendicular directions;  $\Delta g$  - variations of the relative values of gravity /the values after the decimal point are shown; 1-7 - numbers of gravitational precursors; 1-7 - numbers of the Sichuan earthquakes.**

Thus, we single out two types of gravitational anomalies on the second channel. The first type of anomalies - the precursors and the second type of anomalies arise as a result of earthquakes that have already occurred.

#### 4) Analysis of gravitograms of the third channel

Let's consider the record of the third channel, which characterizes  $\Delta g$  - variations of the relative values of gravity (the values after the decimal point are shown). These anomalies have been recorded by a special gravimeter of the ATROPATENA station. We have identified seven intensive anomalies in the record from 24.04.2008 to 06.05.2008, after which the value of  $\Delta g$  significantly increases by 2.3 mGal. This value remains unchanged till 12.05.2008, after which it drops sharply by 1.2 mGal. In the period from 12.05.2008 to 13.15.2008, seven secondary anomalies of smaller amplitude were recorded. Starting from 13.05.2008, the  $\Delta g$  value is stabilized and no anomalies are recorded.

#### 5) Results of gravitogram analysis

It should be noted that analyses of more than 100 gravitograms records by ATROPATENA stations before, during and after strong earthquakes in other regions of the world in the periods from 2008 to 2011 allowed confirming registration of gravitational precursors before of strong



earthquakes [1, 13, 19]. The first type is anomalies before strong earthquakes - they are precursors of earthquakes and the second type is anomalies after strong earthquakes (secondary anomalies), which are formed as a result of radiation of tectonic waves at the time of the earthquake and release of tectonic energy. Between these two types of anomalies, in the overwhelming majority of cases, a long-term gravitational anomaly with the increased or decreased value of the  $\Delta G$  index and  $\Delta g$ , which remains stable, usually for 2-15 days, is recorded. These characteristic features of gravitational anomalies on the records of gravitograms before, during and after strong earthquakes are observed in more than 90% of cases. According to the authors' opinion, which is supported by the results of numerous experiments, the gravitational precursors of strong earthquakes are the result of the emission of tectonic waves (stress waves) by earthquake centers 2-10 days before the earthquake [1, 13, 19]. The time of registration of gravitational precursors of strong earthquakes also depends on the distance of the ATROPATENA station to the epicenter. The periods of three-dimensional gravity anomalies vary from 10 minutes to 10-12 hours and depend on the geological structure of the epicentral zone. It should be emphasized that the seismic stations that are included in the set of all ATROPATENA stations of earthquake forecasting do not register any anomalous seismic signals during the registration of gravitational precursors. The authors came to a very important conclusion:  $\Delta G$  index and  $\Delta g$  they are universal precursors of earthquakes and are recorded in more than 90% of cases.

### **Conclusion**

The conclusions drawn by the authors can be divided into two categories: experimental results and the model proposed by the authors.

#### ***Experimental results:***

- To monitor spatio-temporal variations of the gravitational field, special detectors named ATROPATENA stations have been developed and made. The detectors continuously measure the value of the gravitational constant  $G$  in mutually perpendicular directions and relative values of gravity  $\Delta g$ .
- Before and after the Mega Earthquakes in Asia and Southeast Asia, variations of the Earth's gravitational field were registered at large distances from the epicenter (near 8000 km); they were measured with the ATROPATENA stations in the following location: Baku (Azerbaijan) and Yogyakarta (Indonesia).
- Indications of the Cavendish balance when measuring the gravitational constant  $G$  are influenced by spatio-temporal changes in external gravitational fields of geological origin, which alter over time indications of the true values of  $G$ .
- Measuring the true value of the gravitational constant  $G$  on the Earth's surface with accuracy greater than the second digit after the decimal point is not possible due to the spatio-temporal variations of the gravitational field as a result of the impact of geodynamic processes.
- For the first time, the true cause of variations of the recorded values of the gravitational constant  $G$  has been identified. These variations were the subject of scientific dispute throughout the last century.

### **References**

1. CODATA, The Physical Measurement Laboratory. (PML).
2. <https://www.nist.gov/sites/default/files/documents/pml/div684/fcdc/Motivation.pdf>
3. Elsasser W. H. (1969). Convection and stress propagation in the upper mantle. *Earth and Planetary Interiors.*, (223-246), New York: Willey

4. Geller R.J. (1997). Earthquake prediction: a critical review. *Geophys. J. Int.*, 131, 425-50.
5. Geller, R.J., Jackson D.D., Kagan, Y.Y. & Mulargia F. (1997). Earthquakes cannot be predicted. *Science*, 275, 1616-1618.
6. Gorbunova E. A., Sherman S. I. (2012). Slow deformation waves in the lithosphere: Registration, parameters, and geodynamic analysis (Central Asia). *Russian Journal of Pacific Geology*, 6 (1), 13-20.
7. Hasanov A. A. , Keramova R. A. (2006). Reflection of global geodynamical processes in seismic-geochemical mode of fluids of Azerbaijan at the example of catastrophic earthquake in the Indian ocean (26.12.04; MLH =8.9), *Geophysics of XXI century*, (pp. 326-330). Moscow: Scientific World.
8. Keilis-Borok V. I., Shebalin P. N. (1999). Dynamics of the lithosphere and earthquake prediction. *Physics of the Earth and Planetary*, 111, 179-327.
9. Khain V. E., Khalilov E. N. (2006). Tideless variations of gravity before strong distant earthquakes. *Science Without Borders*, 2, (pp. 319-339), Innsbruck: SWB.
10. Khalilov E. N., Starostenko V. I., Kendzera A. V., Mubarak A., Qaisar M., et al. (2011). Global gravitational effects before and after strong M8.9 JAPAN earthquake of March 11, 2011, *Proc. Int. Congress. Natural Cataclysms and Global Problems of the Modern Civilization*, (pp.57-69), Istanbul: SWB.
11. Khalilov E. N. (2013). Earthquake prediction method and device for the implementation there of., Geneva. WO 2013/096997, Eurasian Patent 018373. Geneva: World Intellectual Property Organization (WIPO).
12. Khalilov E.N. (2004). *Gravitational waves and geodynamics*. Baku-Berlin-Moscow: ICSD/IAS.
13. Khalilov E.N. (2009). About influence of geodynamic processes on the results of measurements of Cavendish balance. *Science Without Borders*, 3, (pp.398-410). Insb.: SWB.
14. Khalilov E.N. (2009). *Global network for the forecasting of earthquakes. New technology and new philosophy*. London: SWB.
15. Kopilova G. N., Pinegina T. K., Smolina N. N. (2007). Seismic-hydro-geological effects of the strongest earthquakes (of Kamchatka region), *Proc. of scientific meeting. Problems of modern seismic geology and geodynamics of Central and Eastern Asia*. 2, (pp.166-173), Irkutsk: SB RAS
16. Lehner F. K., Li V. C., Rice J. R. (1981). Stress diffusion along rupturing boundaries. *J. Geophys. Res.* 86, (N B1), 6155-6169.
17. Ludwin R. S. (2001). Earthquake Prediction. *Washington Geology*. 28 (3), 27.
18. Lyubushin A. A. (2008). Micro-seismic noise in a minute's diapason of periods: properties and possible forecasting features. *Physics of the Earth*, 4, 17-34.
19. Petrova L. N., Orlov E. G., Karpinskiy V. V. (2005). Large-scale deformations of the Earth before strong earthquakes on the observations with the help of seismic-gravimeters, *Abstr. Physical bases of forecasting the rock failure*. VII International school-seminar. (p. 46.). Moscow: Geophysical observatory "Borok".
20. Sobolev G. A., Lyubushin A. A., Zakrjevskaia N. A. (2008). Asymmetric impulses, periodicity and synchronization of low- frequency microseisms. *Volcanology and seismology*, 2, 135-152.

## **GLOBAL GRAVITATIONAL EFFECTS BEFORE AND AFTER STRONG M8.0 SICHUAN EARTHQUAKE ON MAY 12, 2008**

**<sup>1</sup>Wang Lanmin, <sup>2</sup>Elchin Khalilov**

*<sup>1</sup>China Earthquake Administration, Lanzhou Institute of Seismology*

*<sup>2</sup>President of the Global Network for the Forecasting of Earthquakes (GNFE), E-mail: [prof.khalilov@ias-as.org](mailto:prof.khalilov@ias-as.org)*

### **Abstract**

Before and after the strong magnitude 8.0 earthquake which hit the in Sichuan, China on May 12, 2008, some gravitational effects were registered in large areas across

the Eastern Hemisphere as far as 4850 km away from the earthquake's epicenter. The gravity anomalies were measured experimentally using ATROPATENA station for the forecasting of earthquakes - new geophysical registering device deployed in Baku, Azerbaijan. The station continuously measure changes in time of the natural gravitational field in three mutually perpendicular directions. It has been established that indications of the Cavendish balance can be influenced by the dynamics of lithospheric stress fields altering the density and mass of large rock strata under the measuring stations before strong earthquakes. The authors believe that those stresses can be carried by tectonic waves. The effects registered provide a theoretical and experimental basis for initiating creation of an international network for monitoring and early warning of seismic hazards.

**Keywords:** earthquake forecasting; earthquake prediction; gravitational precursors; *tectonic waves*; *ATROPATENA station*; *seismology*; *geodynamics*; *geotectonics*.

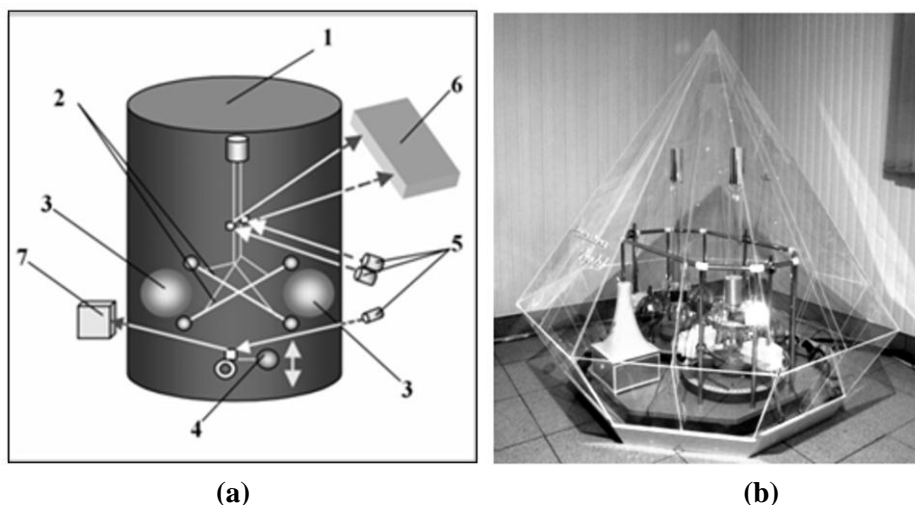
### **Introduction**

Variations of the measured values of the gravitational constant  $G$  have been repeatedly registered by scientists from a number of countries [1, 2]. The results of research of variations in  $G$  were published in World Data Center (3). In (4, 5), it is shown that variations of the gravitational constant have a certain cyclicity. In particular, many years' monitoring of the gravitational constant  $G$  has led the authors (4, 5) to the conclusion about variations in time of the measured  $G$  values starting from the second digit after the decimal point. According to the authors (5), the observed variations can not reflect the gravitational influence of the Sun, Moon or the planets of the Solar system. The authors (5) do not rule out the possibility of solar activity's influence on variations of the measured  $G$  values. In (6), the possible influence of super-long gravitational waves on indicators of the Cavendish balance is referred to. However, no research has offered any satisfactory explanation for variations in time of the measured  $G$  values despite them being registered by a number of scientists (6).

### **Methodology**

A new instrument for experimental study of the space-time variations of measured values of  $G$  was created, called the ATROPATENA detector /Khalilov E.N., PCT patent, 2013, (7). ATROPATENA is a system of sensors closed and isolated from the environment, using the physical principle of the Cavendish balance, with small

weights on the ends of two (instead of one) mutually perpendicular balance-beams hung by threads 2.



**Fig. 1. (a) the ATROPATENA instrument is shown schematically; (b) – Photo of ATROPATENA CRYSTAL Kh11 Station in Baku (Azerbaijan).**

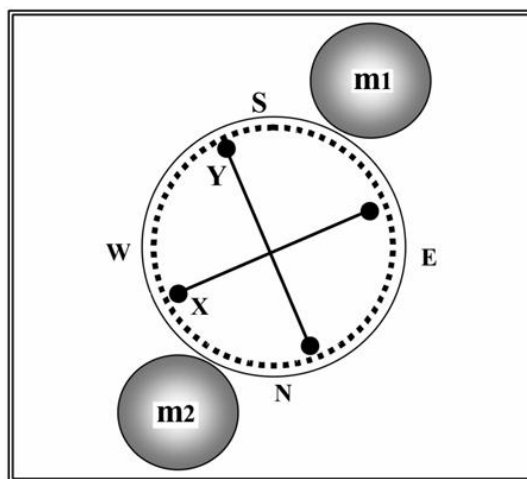
**1 – glass body of the detector; 2 – balance-beams with small weights on the ends; 3 – big weights; 4 – trial weight hung on elastic lever; 5 – laser emitters, 6 – sensitive optical matrix for horizontal sensors, 7 – sensitive optical matrix for vertical sensor.**

Between the small weights large weights are placed equally spaced 3, Fig.1 (a). The third measuring sensor, the trial mass 4, is hung on a special elastic lever and makes available the possibility of vertical displacements during changes in the relative values of acceleration of gravity,  $\Delta g$ . Variations of  $\Delta g$  are stipulated for lunisolar floods and for the appearance of local gravitational anomalies, which can be caused by the changing of density of rock mass under the instrument as a result of changes in their stress condition, and consequently their mass.

As seen in the scheme, on the balance-beams with the weights 2 and on the lever of the vertical sensor 4, there are tiny mirrors on which three laser beams are directed. Being reflected from the mirrors, the beams hit the sensitive optical matrix 6 and 7, where the transformation of optical signal from laser mark into electric signals and their transmission into an analog-to-digital converter occurs. After that, the digital signal is transmitted to a special block of the computer as the next record in a special format. The software, written at the Scientific-Research Institute of Prognosis and Studying of

Earthquakes (SRIPSE), automatically records the information in the form of separate files for a period of time determined by the operator.

The entire sensitive system is placed into the special, isolated from the environment, glass body 1, where a deep vacuum has been created and is constantly supported ( $10^{-4}$ MPa). Temperature sensors accurate to  $0.1^{\circ}\text{C}$  are placed in different sections of the sensitive system and connected to the temperature control block. For excluding the mechanical effects and for better heat insulation, the vacuum body with the sensitive system is placed into translucent plastic body which also allows for visually observing the work of the system Fig.1 (b). Together with the noted sensors, ATROPATENA is also provided with a digital seismic station using a three-component seismic receiver, the information of which is also transmitted to the computer and is continuously digitally recorded in three channels X, Y, and Z. The registration of seismic fluctuations is necessary in order to exclude the possible influence of these fluctuations on destabilization of the sensitive system of the ATROPATENA detector and the appearance of false anomalies caused by seismic processes. The remote control of the detector and remote pickup of information minimize the external influences on the sensitive system. All elements of the sensitive system have been made of non-metallic materials to exclude the influence of magnetic fields and electromagnetic radiation on these elements. ATROPATENA is placed in the building of the Scientific Research Institute of Prognosis and Studying of Earthquakes in Baku (Azerbaijan). Since 1 April 2007 the station has been in operation, and has recorded high-quality information about variations of the gravitational field over time in three axes X, Y, and Z, and the seismologic information simultaneously recorded by means of the Tethys-SD wide-band digital seismic station. First, ATROPATENA was provided for experimental research on the possible influence of super-long gravitational waves on indications of the Cavendish balance. However, this detector does not measure changes in the gravitational constant  $G$  but rather deviations of the Cavendish balance's indications, being influenced by altered external masses of geological origin. It should be taken into account that astronomical masses such as lunisolar tides affect indications of the Cavendish balance as well. But this influence is very weak and is reflected in the gravitational constant values in the fifth and sixth digits after the decimal point (6). On the gravitograms, the graph  $G_x$  reflects the movement of the balance-beam X, and the graph  $G_y$  reflects the movement of the balance-beam Y (Fig. 2.), the graph  $G_z$  reflects the changes of gravity, that is, the vertical movements of the trial weight. An increase of values  $G_x$  and  $G_y$  means approaching of small weights on the balance-beams to the large weights, and a decrease means moving away from the large weights. On the coordinate axis are shown the conventional units, which reflect the deviation amplitude of small weights on the ends of balance-beams relative to large weights.



**Fig. 2. Schematic sketch of actual orientation of the Cavendish balance in the ATROPATENA station**

The registration of values of all three sensors is carried out with discontinuity in one second. Using of red lasers with the length of wave 645 nm and special optical matrixes for registration of the laser mark and its displacements allowed registering the deviations of laser-beams on the angle to 0.1 degree. The whole process of registration takes place in digital form automatically, without participation of the operator, and the received time series are archived by means of a special program. These deviations correspond with variations of gravitational constant  $G$  in the third and fourth digits after the decimal point.

#### **ATROPATENA station's measuring parameters**

The ATROPATENA station measures the  $\Delta G$  index which is the difference between the gravitational constant  $G$  (initially measured  $G$  value) and measured values of the Cavendish balance at the measurement time –  $G_F$ :

$$\Delta G = G - G_F \quad (1)$$

The ATROPATENA-AZ station (Baku, Azerbaijan) was used to register gravity anomalies before strong earthquakes, namely in Japan on 7 May 2008 and Sichuan, China on 07, 12, 13 and 17 May 2008 (8). Since only relative changes of the

gravitational field reflecting deviations from the initially measured  $G$  value are important for researchers, a conventional index of variations of the gravitational field  $\Delta G$  was taken as a basis for registration and subsequent analysis. To convert the  $\Delta G$  index into a gravitational constant  $G$  measuring unit, the recorded  $\Delta G$  index should be accepted at the first approximation as the  $G$  value starting from the second digit after the decimal point. According to **CODATA (9)** as of April 2011, the value of the gravitational constant  $G$  is  $6.674\ 28 \times 10^{-11} \text{ m}^3 \text{ kg}^{-1} \text{ s}^{-2}$ , standard uncertainty  $0.000\ 67 \times 10^{-11} \text{ m}^3 \text{ kg}^{-1} \text{ s}^{-2}$ , relative standard uncertainty  $1.0 \times 10^{-4}$ , concise form  $6.674\ 28(67) \times 10^{-11} \text{ m}^3 \text{ kg}^{-1} \text{ s}^{-2}$ . So, only two digits after the decimal point remain unchanged in the measured value of the gravitational constant  $G$ ; from the third digit on, the ATROPATENA stations register periodical spatio-temporal variations that depend on the location of the recording device and its spatial orientation:

$$G_F = 6.67(\pm\Delta G) \times 10^{-11} \text{ m}^3 \text{ kg}^{-1} \text{ s}^{-2}(2)$$

Where  $G_F$  is the actually measured value of the gravitational constant at the measurement time. Previous studies have found that  **$\Delta G$  records obtained using the mutually perpendicular Cavendish balance** are not always synchronized and often lack a pronounced correlation (8). This fact can also be observed from the records of all the stations before and after the disastrous Japanese earthquake of March 11, 2011.

Along with measuring  $\Delta G$ , the ATROPATENA stations simultaneously register variations in time of relative values of gravity  $\Delta g$ , using a microgravimeter installed inside the vacuum tank.  $\Delta g$  values are also measured in arbitrary units to facilitate research. If necessary, the measured  $\Delta g$  values can be converted to **mGal**.

#### **4. Experiment participants**

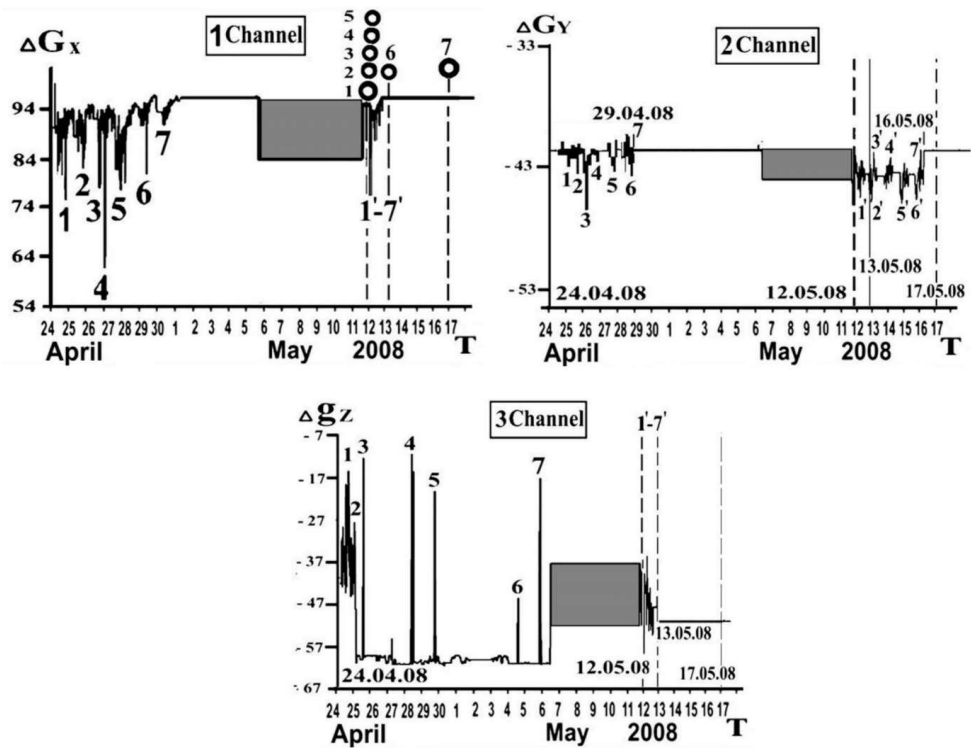
Among the participant of the experiment were organization – full members of the Global Network for the Forecasting of Earthquakes (**GNFE, London, UK, [www.seismonet.com](http://www.seismonet.com)**): **Scientific Research Institute of Prognosis and Studying of Earthquakes (Baku, Azerbaijan)**.

#### **Measurement results**

**The measuring done with the ATROPATENA stations** located in Yogyakarta, Indonesia (station 1); Islamabad, Pakistan (station 2); Baku, Azerbaijan (station 3) and Istanbul, Turkey (station 4) have revealed that all stations registered intense gravity anomalies (deviations from the gravitational constant  $G$ ) starting from the second and third digit after the decimal point, Fig. 3 shows records (gravitograms) of all

ATROPATENA stations on three channels. On March 7-8, the first-channel gravitogram of the station 1 recorded three gravity anomalies located next to each other and marked 1, 2, 3 followed by a period with no anomalies until March 13, 2011. Starting from March 13, the station went on recording intense gravity anomalies marked 4, 5, 6. The second and third channels also registered intense gravity anomalies before (March 7-8) and after the earthquake, from March 13. A characteristic feature of the station 1 gravitogram records is the presence of a pronounced period of the constant gravitational field from 13:58 on March 7 to 6:12 on March 13, 2011 designated as an area "A" during which the gravitational field was stable. So, the gravity anomaly before the Japanese earthquake was registered by the station 1 (Indonesia) three days before the shocks. We have identified a similar area "A" for a relatively stable period of the gravitational field on all gravitograms from all other stations 2-3. As seen in Fig.3, the area "A" is gradually shifting to the right as the distance between the stations and the earthquake's epicenter grows. In our view, the anomalies 1 and 2 are associated with two strong foreshocks with magnitudes 7.2 and 6.3 which occurred on March 9 in the epicenter area of the Japanese earthquake, preceding the strong earthquake of March 11. The gravity anomalies 4-6 are associated with strong aftershocks following the main shock. Due to the large number of strong aftershocks (38 aftershocks with magnitude over 6 from 11 to 17 March 2011 according to USGS), we have been unable at this stage of investigation to identify the registered anomalies with specific aftershocks. Therefore in Figure 3, only identified anomalies' numbers are shown. The station closest to the epicenter is station 1 in Indonesia (5,950 km), followed by station 2 in Pakistan (6,150 km), station 3 in Azerbaijan (7,650 km), and the station farthest from the epicenter is station 4 in Turkey (9,020 km). Analysis of the records shows that the frequency attribute of the anomalies depends on the distance from a station to an earthquake's epicenter. The highest-frequency anomalies were registered by the Indonesian station – Fig. 3 (1), the frequencies of the Pakistan station-recorded anomalies are comparatively lower – Fig. 3 (2). The station in Azerbaijan registered anomalies with longer periods and a lower frequency than those in Pakistan – Fig. 3 (3). The lowest-frequency records were registered by the Turkish station – Fig. 3 (4). The gravitograms in Fig. 3 (1) and 3 (2) reveal all gravity anomalies 1-6. In the gravitogram shown in Fig. 3 (3), only anomalies 1 and 3 on the second channel of the station 2 are identified. Anomalies 1-3 and 4-6, in our opinion, can be merged into a single anomaly with a long period as a result of the attenuation of high frequency components at great distances from the epicenter of an earthquake. In the gravitogram shown in Fig. 3 (4), the anomalies 1-3 we have identified are merged into a single large anomaly due to the attenuation of high frequency components.





**Fig.3. 1, 2 and 3** - records of the first, second and third channel of the station;  $\Delta G_x$  and  $\Delta G_y$  indexes which is the difference between the gravitational constant  $G$  (initially measured  $G$  value) and measured values of the Cavendish balance at the measurement time –  $G_{Fin}$  two mutually perpendicular directions ( $\Delta g$  - variations of the relative values of gravity /the values after the decimal point are shown/).

Region “A” on different gravitograms is shown as higher or lower values of the gravitational field, which is related, in our view, to different orientations of the Cavendish balance toward the earthquake’s epicenter. The shift in the starting time of registration of the region “A” toward increasing is clearly recorded as the distance between the stations and the earthquake’ epicenter grows. This may indicate wave-like behavior of the geological factor that causes gravity anomalies.

### Possible physical model

What physical model of manifestation of gravity anomalies can be considered for these experiments? Currently, in our view, the most optimal is the model based on emission of slow stress waves (tectonic waves) from the focus of an imminent earthquake immediately before the shock. The possibility of existence of slow mechanical waves in the lithosphere has been shown theoretically in the works (10, 11)

and other studies. Subsequent research and works by E.N. Khalilov (12) corroborate the generation of these waves by the focuses of imminent strong earthquakes and possibility of recording them with the use of the Cavendish balance.

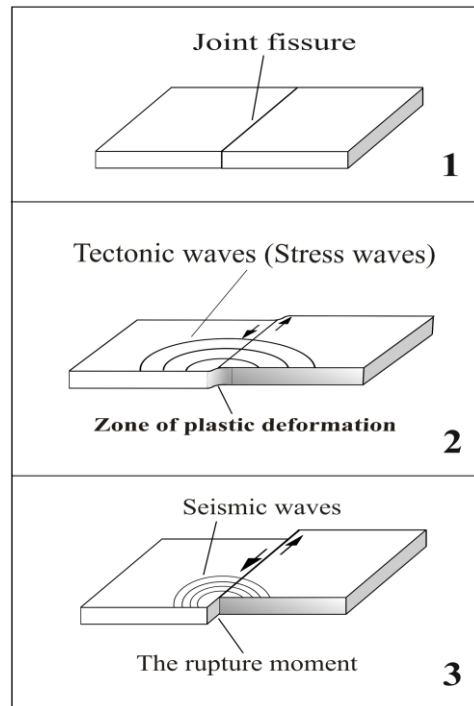
Besides, there are some features in the ATROPATENA station records that can be indirect evidence of the wave origin of the observed gravity anomalies:

1. Before the powerful earthquake with M8.0 in Sichuan, China on May 12, 2008 ATROPATENA-AZ1 station recorded identified intense gravity anomalies. With the recording stations getting farther from the earthquake's epicenter, the date and time when the initial record for the gravity anomaly was written shift forward.

2. As the distance between the recording station and the earthquake's epicenter grows, less high-frequency gravity anomalies and appearance of low-frequency anomalies can be observed. Records from station 1, Fig. 3 (1), reveal signals with the highest frequency.

In station 2 records, Fig. 3 (2), the anomaly period is appreciably larger. At station 3, Fig. 3 (3), the observed record has an even lower frequency and merging of some high-frequency anomalies can be noticed. Finally, only very low-frequency anomalies are seen in the records of station 4, Fig. 3 (4). This pattern of frequency change in the station records may be indicative of the attenuation of high-frequency components of the wave as the distance from the epicenter increases and of the predominance of low-frequency components at a maximum distance from the epicenter, which is a characteristic feature of wave-like processes.

Let us consider the process of rupture of a crust fragment during the motion of tectonic blocks along the fissure plane as a possible model for the generation of tectonic waves before strong earthquakes. Fig. 4.1 shows a fragment of the Earth's crust with a fissure before the deformation process. Fig. 4.2 pictures the moment when crustal blocks move relative to each other on the fissure plane at the time of plastic deformation. Plastic deformation precedes the rupture of a continuous medium and is accompanied by alternating voltage which can be a source of stress waves or tectonic waves. At a certain moment of plastic deformation and motion of tectonic blocks, the breaking point for crustal blocks' adhesion strength is reached, followed by a rupture and abrupt movement of the crustal blocks leading to emission of tectonic waves and an earthquake as shown in Fig. 4.3.



**Fig. 4. Tectonic wave generation model. 1 - crust fragment with a fissure; 2 - movement of crust blocks along the fissure at the moment of plastic deformation; 3 – moment of rupture and movement of tectonic blocks along the fissure**

Given that the plastic strain rate is much lower than the rate of motion of the tectonic blocks at the moment of rupture, in the plastic deformation zone there can be formed slow mechanical waves, that is, tectonic waves (stress waves). Plastic deformation of a medium is accompanied by destruction processes, forming of minor cracks which grow and join together as the deformation continues. The formation of cracks leads to emergence of low-frequency seismic waves. This process can be detected by seismic stations, but these waves decay rapidly at a short distance from the hypocenter due to the low energy. That is why station 1, the closest to the epicenter of the Japanese earthquake of March 11 registered high-frequency oscillations which were decaying with the increasing distance from the epicenter. Stations 2-4 more distant from the epicenter could only record very low-frequency components of the tectonic wave spectrum.

### Conclusions

The conclusions drawn by the authors can be divided into two categories: experimental results and the model proposed by the authors.

### **Experimental results:**

- To monitor spatio-temporal variations of the gravitational field, special detectors named ATROPATENA stations have been developed and made. The detectors continuously measure the value of the gravitational constant  $G$  in mutually perpendicular directions and relative values of gravity  $\Delta g$ .
- Before and after the strong magnitude 8.0 earthquake which hit the in Sichuan, China on May 12, 2008, variations of the Earth's gravitational field were registered at large distances from the epicenter (up to 4850 km); they were measured with the ATROPATENA stations in the following location: Baku (Azerbaijan).
- Indications of the Cavendish balance when measuring the gravitational constant  $G$  are influenced by spatio-temporal changes in external gravitational fields of geological origin, which alter over time indications of the true values of  $G$ .
- Measuring the true value of the gravitational constant  $G$  on the Earth's surface with accuracy greater than the second digit after the decimal point is not possible due to the spatio-temporal variations of the gravitational field as a result of the impact of geodynamic processes.
- For the first time, the true cause of variations of the recorded values of the gravitational constant  $G$  has been identified. These variations were the subject of scientific dispute throughout the last century.

### **Model:**

The authors propose a model of emission of slow tectonic waves (stress waves) in the focal region of an imminent earthquake as a result of plastic deformation of crustal layers immediately before the rupture (abrupt displacement). Tectonic waves are a sort of mechanical waves, altering the density of crust layers in the motion process. Alternating changes in the density of the crust layers lead to periodic changes of the mass and, as a consequence, of the gravitational field within the front of the tectonic wave. The monitoring of spatio-temporal changes in the gravitational field can be carried out using special devices consisting of the mutually perpendicular Cavendish balance and gravimeter. This analysis is preliminary and we are going to carry out further and deeper examination of records of all ATROPATENA stations before and after the catastrophic earthquake in Japan on Sichuan, China on May 12, 2008. ATROPATENA-AZ1 station into a single information structure has made it possible to build a global network for geodynamic monitoring and short-term prediction of earthquakes and its constituent system of earthquake forecasting, which is GNFE (12).

### **References**

1. Jens H. Gundlach, Stephen M. Merkowitz. Measurement of Newton's Constant Using a Torsion Balance with Angular Acceleration Feedback Phys. Rev. Lett. 85, 2869 - 2872 (2000).

2. J. P. Mbelek et M. Lachièze-Rey, Possible evidence from laboratory measurements for a latitude and longitude dependence of G, *Gravitation and Cosmology*, 8, 331 (2002).
3. <http://zeus.wdcb.ru/wdcb/sep/GravConst/welcome.html>
4. Izmailov V.P., Karagioz O.V., Parkhomov A.G. Study of variations of the measurement result of the gravitational constant. *Physical thought of Russia*. № 12, 20-26 (1999).
5. Karagioz O.V., Izmailov V.P. Measuring the gravitational constant with the torsion balance. *Measuring techniques. Study of variations of the measurement result of the gravitational constant*. Moscow, № 10, 3-9 (1996).
6. Khalilov E.N. *Gravitational waves and geodynamics*. ICSD/IAS, Baku-Berlin-Moscow, 2004, 330 p.
7. Khalilov E.N. Earthquake prediction method and device for the implementation there of World Intellectual Property Organization (WIPO), Geneva, Publication Date No: 04.07.2013, Publication № WO 2013/096997, International Application № PCT/AZ2011/000016; Eurasian Patent №018373.
8. Khain V.E., Khalilov E.N. Tideless variations of gravity before strong distant earthquakes. *Science Without Borders*. Volume 2. 2006/2006. ICSD/IAS H&E, Innsbruck, 319-339, (2006).
9. CODATA. [http://physics.nist.gov/cgi-bin/cuu/Value?bg|search\\_for=universal\\_in!](http://physics.nist.gov/cgi-bin/cuu/Value?bg|search_for=universal_in!)
10. Elsasser W.H. Convection and stress propagation in the upper mantle. In: *Appl. Modern Phys. Earth Planet. Inter.* N.Y., Willey, 223-246, (1969).
11. Lehner F.K., Li V.C., Rice J.R. Stress diffusion along rupturing boundaries. *J.Geophys. Res.*, v.86, N B1, 6155-6169 (1981).
12. Khalilov E.N. *Global network of forecasting of earthquakes. New technology and new philosophy*. London, SWB, 2009, 65 p.
13. Elchin Khalilov, Vitaly Starostenko, Alexander Kendzera, Ahsan Mubarak, Muhammad Qaisar, RaniSjamsinarsi, Junun Sartohadi, Wahyudi, CavitYatman. *Proceedings of the International Congress "Natural Cataclysms and Global Problems of the Modern Civilization"*. Istanbul, 19-21 September, 2011, pp.57-69
14. *Global Network for the Forecasting of Earthquakes (GNFE)* <http://seismonet.com/>

## **RESPONSIBILITY OF SCIENCE AND TECHNOLOGY FOR ACHIEVING SUSTAINABLE FOOD AND NUTRITION SECURITY**

**P.C. Kesvan**

*DAE - Homi Bhabha Chair & Distinguished Fellow*

*M. S. Swaminathan Research Foundation, India*

*Email: [pckesavan@mssrf.res.in](mailto:pckesavan@mssrf.res.in)*

### **Introduction**

More than a decade has elapsed since a Special Issue of *Scientific American* (September 2005) published a series of articles bearing on "Crossroads for Planet Earth". The topics covered were: population peak, loss of biodiversity, poverty, energy problems, climate change, and water crisis. The Intergovernmental Panel on Climate

Change (IPCC) has been regularly holding conferences involving all the member nations to find ways and means to arrest the average rise in the global temperature below 1.5° C. This now seems rather difficult despite severe warnings by climate scientists that the planet will be hit by “tipping point” when the global average temperature reaches between 1.8 to 2.0° C. The ‘tipping point’ would take the planet into a different and altogether unknown state of equilibrium which could be hostile to the welfare and even possibly the very survival of humans and several other species, mainly the mammals which are hot-blooded and have a rather narrow range of homeostatic adaptation. The IPCC Conferences with all good and serious intentions have largely been far less successful in making all the Member nations to substantially limit the production and release of greenhouse gases. Disappointed on this account, *Nature* editorial wrote in the editorial “The Mask Slips” that The Durban Meeting shows that climate policy and climate science inhabit parallel worlds. Consequently, it seems that it is inevitable that the planet Earth will face the tipping point.

Today, the concern is not just about climate change only. The humans (*Homo sapiens*) the most recent mammals in the evolutionary history, have drastically altered the planetary cycles of long periods of glaciations alternated with brief periods of warming. Climate science studies have revealed that Earth’s climate assessed in terms of average temperatures has never been static. In fact, there is a discernible periodicity in the cyclic alteration between very long glacial and much shorter interglacial warmer periods. Radioisotope studies conducted in Dome C of Antarctica reveal that the paleoclimate of about 650,000 years is dominated by long glacial (~ 100,000 years) and much shorter (10,000 years) inter-glacial (warmer) periods. Based on this cyclic changes, the last warming period, the geological epoch “holocene”, the relatively warmer period of the past 10-12 millennia ought to have ended and the next successive cooling period (i.e. the 100,000 year glaciation) should have commenced. Surely, this has not happened. Hence, the Nobel Laureate Paul Curtzen has coined the term ‘Anthropocene’ to the present, in many ways human-dominated geological epoch, supplementing the Holocene. Steffen W et al. (2011, “The **anthropocene: From global change to planetary stewardship**”, *Ambio* **40** (7), 739-761) emphasize: *Effective planetary stewardship must be achieved quickly as the moments of Anthropocene threaten to tip the complex Earth System out of cyclic glacial – interglacial pattern during which Homo sapiens have evolved and developed. Without such stewardship, the Anthropocene threatens to become for humanity a one-way trip to an uncertain future in a new, but very different state of Earth System.*

It is against the above said background that we should examine the prospects of achieving the goals of ‘**Zero Hunger World**’ (UN Conference RIO+20 at Johannesburg, South Africa in 2002) and the UN Sustainable Development Goals

(SDGs), particularly the Goal Number 2 which has the following aim: *“End hunger, achieve food security and improved nutrition and promote sustainable agriculture”*. And the food and nutrition security must be assured to every one of the projected population of ten billion people by 2050. As of today, more than 1 in 7 people do not have access to sufficient protein and energy from their diet. The UN FAO Report, **‘State of Food Security in the World 2009’**, observes that the number of people suffering from micronutrient deficiency (i.e. hidden hunger) far exceeds those suffering from caloric and protein hunger. About two billion out of the global population of 7.4 billion people today are known to be deficient for one or more micronutrients such as iron, iodine, zinc, vitamin A, vitamin B etc. The question is as to how this goal could be achieved in the light of the fact that the science and technology of today are hardly eco-friendly as also without social and gender equity concerns. The Green Revolution of the 1960s is cited as an outstanding feat of science and technology of the 20<sup>th</sup> century, but even that in the long period of time has proved to be a ‘hatchet’. As Jeffrey Sachs Director, Earth Institute, Columbia University, New York observed, *“Even with all our technological wizardry, we have not yet conquered the Malthusian challenge since we have not yet adopted truly sustainable method of feeding the planet”*.

## **2. Priority attention to what is most basic need for survival**

In a hierarchy of human needs, food and clean drinking water are absolutely basic. It is only when these are adequately met, the other needs such as wealth, comfortable living, fame and recognition and celebrity status are sought after. The world has always had people with total access to balanced diet as well as those who had little or no access to adequate caloric diet. Today, in the world there are about one billion people with insufficient access to satisfy caloric hunger and about two billion suffering from various micronutrients deficiencies. The deficiency of micronutrients (i.e. iron, iodine, zinc, vitamin A, vitamin B) causes maladies called nutritional maladies. The people suffering from nutritional maladies do not exhibit major symptoms of a disease.

Fighting for a “Hunger-free world” has to tackle three kinds of hunger on the one hand and also three essential physical dimensions on the other. The three kinds of hunger are:

(a) **Caloric (i.e. no food at all) hunger** – can be satisfied with provision of cereals.

(b) **Protein hunger** – inadequate or no intake of pulses, poultry, fish, meat, beef, pork etc. This results in stunting of growth especially of children. The developing countries, particularly those with large vegetarian populations have many children, women and men suffering from ‘protein hunger’.

(c) **Hidden hunger:** As already discussed, this is a rather invisible type of hunger caused by micronutrients deficiencies in the diet. This category includes about 2 billion people.

All these three kinds of hunger could be alleviated only with the help of three following provisions:

(i) **Availability of food in the market/shops:** Making available food grains, pulses, oilseeds, vegetables and fruits is a function of ‘production’ locally or importation. Several unfortunate countries in the developing world do not produce enough to meet the local needs, and have ~~no~~enough money either to import. Consequently, the people starve and in the recent years the print and electronic media have been effectively portraying the heart-breaking stories of hunger and deprivation hunger of the children orphaned by civil wars, terrorism etc.

(ii) **Access:** The markets/shops might be loaded with a variety of food items, but people may not have money to buy them. Lack of ‘*purchasing power*’ in such situations as ‘abject poverty’ denies access to food. In India, famine of rural livelihoods (i.e. inadequate jobs/means of livelihoods) is a major cause of food insecurity and hunger of millions of people in the rural households.

(iii) **Absorption:** Lack of clean drinking water in the rural areas of several developing countries leading to gastro-enteric diseases (e.g. dysentery, diarrhoea etc). These block the ‘absorption’ of the injected food; the net result is leaky pot. What have been aforementioned bring out the complexity of the problem of achieving a truly “Zero Hunger” world proposed by the then Secretary – General of the United Nations at the “RIO+20” Conference held in June 2012 in Johannesburg, South Africa.

### **3. Agriculture in epoch Anthropocene**

Agriculture is basically an anthropogenic activity in disharmony with environment, particularly the ecological conservation. The words of wisdom of the Roman farmer Varro (1<sup>st</sup> century B.C) which is not integrated into the modern chemistry-based farming system are: “*Agriculture is a science which teaches us what crops should be planted in each kind of soil and what operations are to be carried out, in order that the land may produce the highest yields in perpetuity*”.

The ‘Green Revolution’ of the 1960s which almost instantaneously transformed India’s then image as ‘begging bowl’ to ‘bread basket’ did not follow Varro’s dictum. In fact, Professor Jeffrey Sachs, Director, Earth Institute, Columbia University, New York noted; “*the great agronomic successes since Malthus’ time including the Green Revolution itself, have come at huge and sometime irreversible environmental costs*”.



The Father of India's Green Revolution M.S. Swaminathan was the first to refer to the new high-yielding agriculture as "exploitative and unsustainable" (M.S. Swaminathan 1968). Norman Borlaug who won the Nobel Prize in Peace for developing the dwarf wheat seeds of the Wheat Revolution was not, however, happy with his close friend Swaminathan's views. The term 'Green Revolution' was coined by William S. Gadd, then administrator to denote the sudden quantum increase (i.e. revolutioner) in the wheat yield than a progressive (i.e. evolutionary) improvement in productivity. Green Revolution involved harnessing the 'dwarf' wheat and rice varieties which could withstand high level inputs of chemical fertilizers (nitrogen, phosphorus and potassium) and copious irrigation and convert the chemical plant nutrients into high amounts grains through photosynthesis. The drawback with tall varieties of wheat and rice is that they 'lodge' (i.e. fall back on the ground under the weight of heavy earhead having large number of well-filled seeds). The yields were impressive indeed until the worsening soil conditions caused in 'yield fatigue'. Writing under the title 'End of Plenty' in *National Geographic* (2009, **215** (6), 26-59) Joel K. Bourne Jr. Writes that Green Revolution has nothing to do with the eco-friendly green label (and green economy) in vogue today and its miracle is over in Punjab, India. The yield growth has essentially flattened since mid-1990 s. Over irrigation has led to steep drops in the water table, now tapped by 1.3 million tube wells, while thousands of hectares of productive land have been lost to salinization and waterlogged soils. Forty years of intensive irrigation, inorganic chemical fertilization and exorbitant application of chemical pesticides have not been kind to the loamy gray fields of Punjab. Far worse is the sharp increase in the incidence of all kinds of cancers among the members of the farming families due to exposure to significant levels of carcinogenic pesticides. The Green Revolution (i.e. chemically intensified farming) has adverse impact on the planetary nitrogen cycle as well. The great technological achievements have in the long periods of time, upset the biogeochemical cycles. Rockstrom J. et al (2009, '**A safe operating space for humanity**', *Nature* **461**, 472-475), refer to the impairment of nitrogen cycle among a few other planetary functions. The Haber-Bosch chemical process to synthesize ammonia (NH<sub>4</sub>) by combining the atmospheric nitrogen and hydrogen under high pressure and temperature greatly accelerated crop productivity by providing nitrates which are taken up for growth and productivity by green plants. This in the long run has led to the accumulation of nitrates on land and aquifers without a corresponding denitrification technology. In nature, there is a balance between nitrates synthesis and its reconversion into nitrogen. Nature's gifts in this regard are the nitrogen-fixing bacteria on the one hand, and denitrifying (i.e. converting nitrate into nitrogen) bacteria, on the other. The vitiation of the Earth's nitrogen cycle, carbon cycle, hydrologic cycle as well as the anthropogenic habitat destruction of the biodiversity do not augur well for

a sustainable future. These planetary level changes are quite immense and detrimental, but there are no effective solutions.

The so-called advances in crop improvement through genetic engineering completely erode the ecological and social pillars of sustainable development. In fact, there is as yet no clear understanding of a host of molecular and cellular events which are triggered in a cell following insertion of a ‘non-native’ gene through unnatural and even violent processes far different from the natural sexual reproduction for gene exchange and recombination of genes. Genes from outside of the native conserved genome are not welcome, and there is considerable disturbance in the gene expression. Products of genes are also altered within the cells of the genetically-engineered organisms. Consequently, unexpected and ‘unintended’ gene products are often encountered. For instance, genetic engineering of alpha amylase inhibitor gene from pea plant into bean plant results in altered structure and immunogenicity (Prescott et al 2005, *J. Agric & Food Chem.* **53**, 9023-9030). Such unintended effects observed in the genetically-engineered crops are now increasingly reported. As of now, there are only pesticide(s) – producing transgenic crops- mainly soy, corn and cotton. Pesticides are well-known endocrine disruptors, teratogens and carcinogens. Recently, the International Agency for Research on Cancer (IARC) a wing of the World Health Organisation (WHO) has declared the pesticide glyphosate (used in “Roundup” in the herbicide-tolerant transgenics) as ‘2A’ carcinogen for humans. The money power and political support in favour of the genetically engineered crops developed by a few multinational companies overwhelm the scientific truth against them. The scenario of the genetically-engineered crops as of now represents “science in post-truth” era. Putting all the available data from the studies on the human health and environment many authors (Dona, A and Aruanitoyannis, I.S, 2009, *Critical Reviews in Food Science and Nutrition* **49**, 164-179; Swaminathan, M.S. and Kesavan P.C. 2018 *Current Science*, Vol. **114** No. 8, 1585-1586); Kesavan P.C. and Swaminathan M.S. 2018 *Science and Culture*, Vol. **84**, 92-98), it is that as of now the experience with genetically engineered Bt and Ht crops over three decades has been very disappointing in terms of productivity, deeply disconcerting from ecological perspectives, and totally unacceptable from health and welfare point of view.

Genetically engineered Bt-cotton hybrids in India and herbicide-tolerant soy, corn and cotton in the USA and Argentina reveal that initial advantages of these crops have not only disappeared but new and highly unmanageable problems have arisen. These are “hatchets” of sustainable agriculture and global food and nutrition security in the long term. Ruth DeVries in her book “**The Big Ratchet**”: “*How Humanity Thrives in the Face of Natural Crisis* ) *A Biography of an Ingenious Species*”, Basic Books, New York 2014, pp. 273) which has been reviewed by Kesavan P.C. (*Current*

*Science* 2015, Vol. **108**, 1550-1551) has described how new technologies which confer benefits in the initial stages act as a “pivot”, how these become stabilized and fixed as ‘ratchet’ for a certain length of time, and then how these became transformed into a “hatchet”. In the present context, “pivot” is a new technology or discovery that suddenly reduces the problems faced by people, that brings new hope. ‘Ratchet’ signifies a period human advances in population explosion, adoption of extravagant lifestyle etc., which eventually overwhelm the ‘pivot’. Also, the new technology could adversely affect the resource-base, and consequently, the ‘pivot’ degenerates into a “hatchet”. In simple terms, technological advances which benefit humanity initially cause environmental and social harm in due course of time. Most of the technologies both developed already and those in the pipeline follow the “pivot-ratchet-hatchet” pathway, and more so in the current epoch Anthropocene. Hence, the need of the hour is to develop eco-technologies which are a blend of modern frontier technologies with the traditional knowledge and ecological prudence of the world’s indigenous tribal and rural communities. The idea of ‘ecotechnology’, it seems, could be traced to the French undersea explorer Jacques Cousteau. Eco technologies largely help to reconcile development and conservation especially in the ‘biodiversity-rich’ regions of the world confined within about 22° to the north and south of the equator.

#### **4. Ecotechnologies foreco-agriculture and eco-enterprises for sustainable food security**

Lessons learnt from the “*Green Revolution*” and “*Genetic Engineering*” technologies over the last several decades is that there is an urgent need to shift our strategies towards sustainable agriculture. With due recognition of the need for concurrent attention to soil health, fresh water, biodiversity, renewable (clean) energy etc., Swaminathan M.S. (2010, “*From Green to Evergreen Revolution: Indian Agriculture, Performance and Challenges*”, Academic Foundation, New Delhi pp. 410) has elaborated his concept of ‘evergreen revolution’ which he had proposed in 1996. He defines the “evergreen revolution” as *achieving productivity in perpetuity without accompanying environmental and social harm*. It has the elements of what Varro (already mentioned earlier) had observed about sustainable agriculture. In today’s parlance, it is the “systems approach” to crop and farm animals husbandry. Its basic tenets are that chemistry-based (chemical) inputs such as inorganic fertilizers and chemical pesticides are increasingly replaced with bio-derived (biological) biofertilizers and biopesticides. Bio fertilizer sare the various microbial organisms which atmospheric fix nitrogen as nitrate in the soil. An age-old method of traditional farming involved crop rotation in which naturally nitrogen-fixing leguminous crops are grown

before a cereal crop. *Sesbania rostrata* has nitrogen-fixing bacteria in the nodules on leaf surface. Cultivating this species and ploughing it in the soil enriches the nitrogen-content (i.e. nitrate) by about 70 to 80 kg of N<sub>2</sub> per hectare. The succeeding paddy crop therefore, would require substantially low level addition of inorganic nitrogen fertilizer. There are also fertiliser trees such as the African fertilizer tree (*Faidherbia albida*) which takes nitrogen from the air and fixes it as nitrates in its leaves, these leaves eventually fall and their nitrates are incorporated into the soil. *Azolla* is an alga that is cultured in special facilities and applied as a nitrogen-containing bio fertilizer. As regards the biopesticides, there are several herbal formulations which do not leave toxic/carcinogenic residues. Thus, these are safe from health and environmental point of view. Even more spectacular is the ingenious use of the parasites and predators in the biological world to contain the serious insect pests of agricultural crops. An example is the use of egg parasitoid (*Trichogramma chilonis*) a tiny wasp that lays its eggs into the eggs of cotton bollworm and consequently the pest production is drastically curtailed. The ingenious use of insect parasites against insect pests is absolutely free from chemical toxicity in the environment.

Natural parasites exist against cotton bollworm (*Helicoverpa armigera*) and fruit and shoot bore rofbrinjal (*Leucinodes orbonalis*).

## **5. Shift from the chemical to biological inputs**

Chemical synthesis of ammonia by the Haber - Bosch process is an extremely energy-consuming process. To combine atmospheric nitrogen and hydrogen, high temperatures at very high pressure are needed. The energy comes invariably from burning fossil fuels which release large amounts of greenhouse gases. And then, as stated earlier, the nitrates produced through chemical synthesis are not denitrified by an equally energetic reverse chemical process. On the other hand, biofertilizers which naturally occur, could be cultured in large quantities with minimal use of energy by rural women in their huts/houses. Doing so provides an income-generating opportunity to the rural poor. Biofertilizers and Biopesticides are the “*biological soft wares*” for sustainable agriculture. Production of these by the landless women in many parts of the developing countries provides an income-generating avenue, and reducing feminization of rural poverty.

## 6. Small holder family farms in world's food and nutrition security

During the epoch Holocene about 10,000 years ago, the *Homo sapiens* started farming and domestication of farm animals. Earlier, about 30 to 40 thousand years ago they transformed wild dogs as pet animals as partners in hunting and also as loyal companions. The then agriculture was large lyecofriendlyexceptin the case of conversion of forestland into cropland. Things, however, rapidly changed soon after the 'Industrial Revolution' that was ushered in with the invention of steam engine by James Watt in 1780. In the middle of the 19<sup>th</sup> century, Justus von Liebig in Germany discovered that nitrogen-containing chemical compounds added to the soil promoted luxurious growth and productivity of plants, particularlythe crop plants. As to the means of commercial production of nitrates (plants uptake nitrogen in the form of nitrates), the Haber-Bosch Process was adopted. And then, in 1939 Paul Muller discovered the insecticidal properties of a chemical compound, DDT had been synthesized much earlier (in 1874) by Othmar Zeidler. The humankind was jubilant as it could get rid of every unwanted insect in the world. Then came the book, "*Silent Spring*" by Rachael Carson (1962 Houghton Mifflin Co., Boston P.400) which described the mass destruction of non-target beneficial organisms by the DDT. The pesticides in general are carcinogens, endocrine disruptors and killers. More recently, Barbara Cohn et al (2015, *J. Clin. Endocrine Metab.*, **100** (8), 2865-2872) have shown that DDT, an endocrine disruptor induces breast cancer in women of about 52 years of age, following their exposure *in utero* in the 1960s. Their mothers who had high exposures to DDT in the 1960s showed high levels of DDT in their system. It is an amazing study of 54-year follow-up of mothers exposed to DDT in the 1960s, the consequent exposure of the female foetuses in such pregnant mothers, and these daughters exposed to high levels of DDT in their mothers' wombs developing breast cancers when they reach about 52 years of age. The study showed that women exposed to the higher levels of DDT in the womb had 3.7 times higher risk of breast cancer than those who had the lowest exposure to DDT. It is, therefore, highly inaccurate to conclude that short-term studies did not reveal adverse effects. Long-term studies foratleasttwoyearsusing chronic feeding of experiments rats/mice are essential to gather reliable data. Today, the Earth's biosphere is accumulating at an accelerated rate several chemical pollutants derived from anthropogenic activities in agriculture, manufacturing industry, nuclear, space, nano- and biotechnologies. The "ecologicalfootprint" (Wackerraagel, M et al 1999, *Ecological Economics* Vol.29, pp.375-390) is overshootingwhilethe 'biocapacity', of the Earth to restore what has been degraded is concomitantly diminishing. Notwithstanding the fact that most of he enlightenedlaycitizens of the world understand that the planet Earth, and in particular, its biosphere are at a crossroad, development

under the globalization goes on largely as “*business-as-usual*” This brings into discussion the Corporate (factory) Farming vis-z-vis Family Farming. Factory farming largely involves monocropping, that is just one high-yielding variety (HYV) of corn, wheat, soy, cotton, paddy or any other. Chemical fertilizers and pesticides (including herbicides) are used liberally. It also aims at having as few farm workers as possible, so that jobless economic growth increases profits. Consequently, automation adds to the numbers of the unemployed. On the environmental side, chemicals and over exploitation of groundwater lead to degradation of land, aquifers and biodiversity. More importantly, it is generally forgotten that food production in the world towards food “availability” is largely due to the toil of about 500 million family farmers throughout the world. The family farms in north America and western Europe could be large (over 100 hectares) whereas those in several developing countries are about 1 to 2 hectares or even less. Labour for farm work involves farm animals for draught purpose. Further the members of the families and friends also contribute labour and resources.

From the point of protecting farm-based livelihoods, studies show that (<http://familyfarmingahap.weebly.com/family-vs-corporatefaring.html>) corporate farming creates 9.44 jobs displacing 27.97.

So, the number of unemployed people, particularly youth from the farming sector in the developing countries increases. Jobless economic growth breeds discontentment and violence in the hearts of people. Yet another advantage of smallholder family farms is that they can grow a variety of different crops each contributing to nutritional diversity and also addition to farmers income. For example, vegetables, banana, poultry, pulses and oilseeds along with farm animals for milk and meat are included even in small family farms. In a nutshell, the shift from exploitative to sustainable agriculture needs to be in the direction of using biologically-derived inputs than chemically-synthesized inputs to augment yield increase. Further, focusing only on high yields or overcoming susceptibility to a pest or disease alone will not do; concurrent attention to soil health, quality fresh water, rich biodiversity, renewable energy including use of manual labour and farm animals is very essential to achieve what is called “*farming with nature*” and **not** “*farming against nature*”.

## **7. Ecofriendly farming and crop productivity**

An ill-conceived notion is that farming without or with little use of chemical fertilizers and pesticides reduces the yields (kg/ha) substantially. Many organic farmers across the world have shown that this notion is wrong. That productivity increase in perpetuity can be achieved with eco-agriculture has been firmly established by the data of Pretty J (2008, *Phil. Transactions of the Royal Society B* (London) **363**, 447 – 465).

In his paper, “Agricultural Sustainability: Concepts, Principles and Evidence”, the author cites a very large study comprising an analysis of 286 projects in 57 countries. It was found the mean yield increase was 79 % across a wide variety of systems and crop types. The smallholder farms practice sustainable intensification with “green” inputs (biofertilizers, biopesticides) and largely renewable energy (cow dung directly or extracting methane through anaerobic fermentation, solar power, wind power) in contrast to corporate farms which use fossil fuel energy-based inorganic chemical fertilizers, diesel-driven tractors, driers, pumps, harvesters etc. The process of achieving the yield gains through the “*sustainable intensification*” with ‘green’ inputs is slower than in the case of chemical-based intensification of agriculture, but is quite long-lasting (i.e. sustainable) and is also largely free toxic chemical residue.

### **Conclusion**

The burning issue at the very basic survival level is to ensure food production and food security to the burgeoning human population especially in the developing countries such as India and China. There is also growing consumerism and unsustainable, extravagant life-style. The detrimental consequence is that Earth’s resources forming the ecological foundation of sustainable agriculture are rapidly depleted/degraded. Requisite energy in the agricultural sector is also an issue. It is now obvious that modern technologies which are not eco friendly and socially (including gender) equitable impact negatively on the present and future prospects of global food and nutrition security. Should the goal be sustainable food security, then an innovative thinking in science and paradigm shift to ward ecofriendly farm technologies are essential. The globalisation has been largely focusing on economic growth and that is one of the reasons for the hesitation on the part of several countries not to implement the climate accord of reducing emissions. This paper aims at putting ‘ecology’ and social issues of humankind in the centre and building economic goals as secondary to global food security around conservation. As it stands, the humankind is like a sitting duck not even able to understand the geobiophysical consequences of the onset of “tipping point”. The humankind should follow the ‘wisdom’ of Albert Schweitzer (Nobel Laureate, theologian, philosopher and journalist (1875-1965) who said “*Man has lost the capacity to foresee and forestall. He will end by destroying the earth*”. Mahatma Gandhi also stressed the point of restoring harmony with nature and not try to ‘conquer’ it.

## **EARTHQUAKE FORECAST MANAGEMENT SYSTEM (EFMS)**

**Farid Khalilov**

*Global Network for the Forecasting of Earthquakes*

*e-mail: int.academy.science@gmail.com*

### **Abstract**

The international experience in creation of weather forecast and tsunami warnings management systems has been analyzed. An attempt was made to structure the main methodological principles of forecasting the natural disasters. The author developed the criteria of a system of managing the earthquake forecasts and shows the examples of its possible structure. Two main aspects have been considered: methodological guidelines for the providing the short-term earthquake forecast and methodological instructions about the actions of the state authority on emergency situations management in obtaining the forecast. The author presents the main criteria for the earthquake forecast management system.

**Keywords:** earthquake forecast, emergency situations management, forecast management.

### **Introduction**

The emergency situations management system in different countries has a different structure and legislative base. The unified state system of emergency situations in most countries unites the government bodies of all levels and public organizations, whose competence includes functions related to ensuring the security and protection of the population, warning, response and actions in emergency situations (ES) /1-6/. To effectively manage the emergency situations in different countries, the laws have been adopted that regulate the coordination and management of emergency situations. The problem of earthquake forecast is directly related to the management of emergency situations. Meanwhile, no country in the world has a legislative base and methodological guidelines governing the issuance of earthquake forecasts. At the same time, in most cases, the legislative bodies of states operate with the stereotype of outdated views about the ineffectiveness of existing methods for earthquake forecast. In turn, this position of state officials hinders the successful introduction of new progressive methods of earthquake forecast into practice. To solve the problem of



effective implementation of innovative technologies for forecasting earthquakes in practice, the author suggests that in the emergency situations management system to provide for "earthquake forecast management system", as one of the main independent units. The problem of introduction of technology for earthquake forecast is directly related to ensuring national security of any country. Meanwhile, it cannot be effectively solved without the development and implementation of the "Earthquake Forecast Management System (EFMS)". The problem of forecasting earthquakes is usually treated as purely technological. The experience of implementing the new technology of short-term earthquake forecasting of the Global Network For the Forecasting of Earthquakes (GNFE) in different countries (Azerbaijan, Pakistan, Indonesia, Turkey, Ukraine) showed that two main problems arise during the implementation: technological and regulatory-administrative. The technological problem was solved in principle by GNFE by means of the effective application of the system of short-term earthquake forecasting, tested for 10 years, based on the network of ATROPATENA earthquake forecasting stations located in different countries /7-9/. Meanwhile, the lack of clear guidelines and legislative framework ensuring the effective integration of the earthquake forecast system and the emergency situations management system hampers the rapid and effective implementation of a new technology of earthquake forecast.

### **Methodology**

When creating the Earthquake Forecast Management System (EFMS), it is necessary to take into account the already available experience of forecasting various disasters. Many years of successful experience in the development and implementation of the meteorological forecasting system and the tsunami warning system have shown that the problems of managing and creating a regulatory framework for disaster forecasting systems have practically the same value along with the solution of technological aspects /10-12/.

The weather forecast is a scientifically grounded assumption about the future condition of weather in a certain point or region for a certain period. The forecast is compiled by meteorological services on the basis of meteorological methods. The accuracy of meteorological forecasts largely depends on the correctness of the physical-mathematical model of atmospheric processes and the system of mathematical modeling /10/. Another type of forecast of natural disasters can be considered a tsunami warning. In 1965, under the auspices of the Intergovernmental Oceanographic Commission of UNESCO (IOC), an Intergovernmental Coordination Group on the System of Tsunami Warning and their Mitigation in the Pacific Ocean was established. The international tsunami warning system in the Pacific Ocean currently includes 46 countries. In addition, there was established a Tsunami Warning Center in the Pacific Ocean in

Hawaii, from where the system is managed. Its work is provided by the National Oceanic and Atmospheric Administration (NOAA, USA). The activity of the Center is also coordinated with the work of the Tsunami Warning Center in the north-west part of the Pacific Ocean, located in Japan. The Tsunami Warning Center assesses the threat posed by the tsunami after the earthquake and notifies the countries that are on its way /11-12/.

The Tsunami Warning System in the Pacific Ocean has a direct access to more than 150 seismic stations around the world that provide information about all earthquakes with a magnitude more than 5.5 on the Richter scale. In addition, the System receives data from almost 100 tide-gauges and sensors in the Pacific Ocean, which record the appearance of a tsunami and estimate its scale.

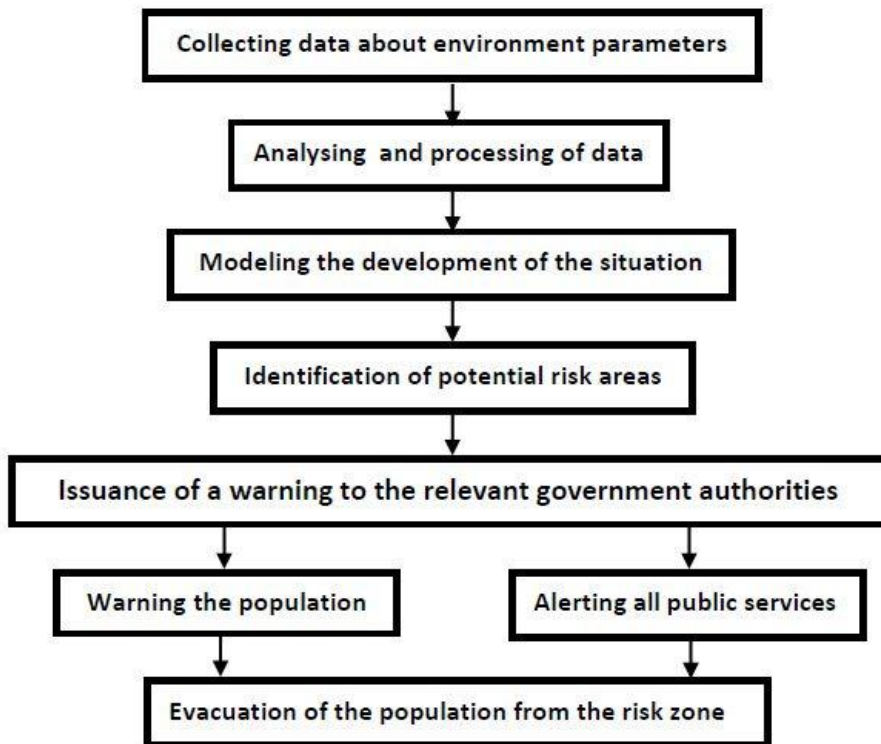
These sensors allow to determine with high accuracy the degree of danger of a tsunami. It means that a tsunami warning can be announced 5-10 minutes after the earthquake /12/. Despite the available similar elements of the meteorological forecast and the tsunami warning system there is a fundamental difference between them.

A meteorological forecast is an advance modeling of the possible development of a meteorological situation based on existing meteorological factors. Meanwhile, the tsunami warning system is based on mathematical modeling of development of tsunami wave from the time of the onset of a strong earthquake in the Earth's crust and the registration of the tsunami wave on the ocean surface, monitoring of direction and all parameters of its movement. To notify the population of an approaching wave, all available methods are used at once: SMS, e-mail, fax, telex, radio, sirens and special systems of emergency notification. This system has been working reliably by this time. The main difference between the weather forecast and the tsunami warning is that the weather forecast is based on an attempt to model the event that has not yet occurred.

The tsunami warning system is based on the fact of recording the event (earthquake) that has already occurred, as a result of which a tsunami and subsequent modeling of tsunami wave propagation may form. If the forecast can be of different types, depending on the time period from the forecast to the onset of a particular atmospheric process, the tsunami warning period is strictly time-limited and depends on the distance between the potential tsunami zone and the epicenter of a strong earthquake. Meanwhile, in both cases, both as in the meteorological forecast and during warning about the tsunami there is much in common. The author has drawn up a scheme that characterizes the general stages of forecasting and warning about natural disasters, fig. 1. It should be noted that each stage shown in the scheme (fig. 1.) must be accompanied by the development and approval of standards and methodological guidelines approved by the relevant government body. The ideal one is the approval of international and national standards for the Earthquake Forecast Management System.

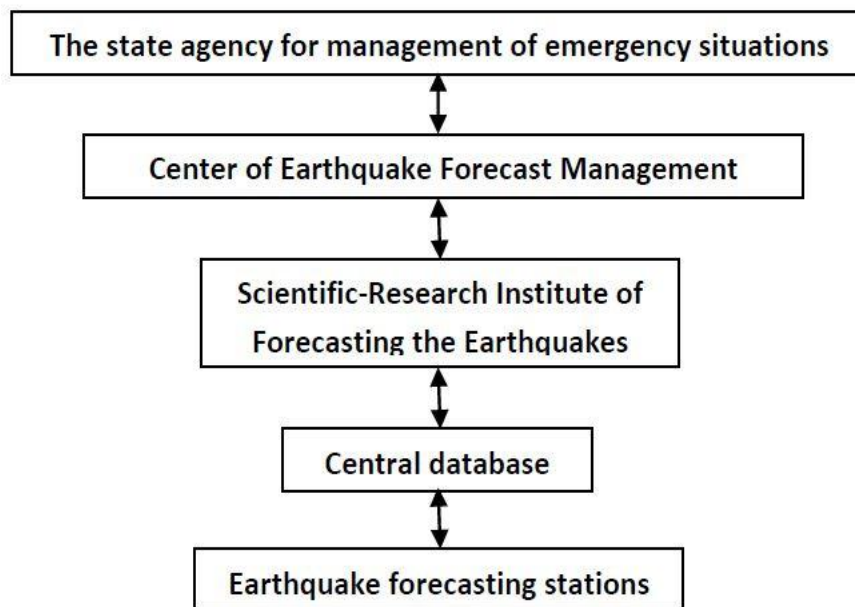
## **The Main Criteria For Creating The Earthquake Forecast Management System**

The solution of the problem of selecting the main criteria in the earthquake forecast management system includes two main aspects: the development of methodological guidelines for the providing a short-term earthquake forecast and methodological instructions about the actions of the state emergency situations management authority in obtaining the forecast.



**Fig. 1. The scheme that characterizes the general stages of forecasting and warning about natural disasters.**

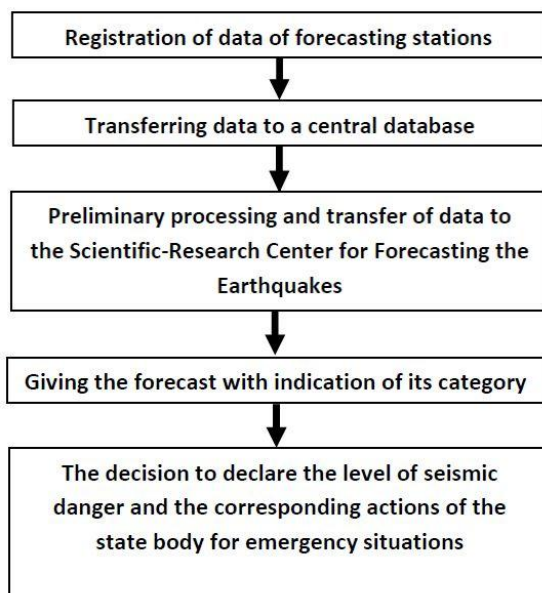
To demonstrate the example of creating the structure of the earthquake forecast management system, we have based on the already existing and well-proven Global Network for the Forecasting the Earthquakes – GNFE, fig. 2.



**Fig. 2. Structure of earthquake forecast management system**

The process of managing the earthquake forecasts includes the stages shown in Fig. 3. As it can be seen from the structure of the process of earthquake forecast management, there are several stages closely connected with one another. The very first stage is the registration of geophysical parameters by earthquake forecast stations, which are placed in a certain order on the forecasted territory and connected to a single network. At the second stage, the registered data is transmitted via communication channels to the central database, where the data is collected and archived in a certain format. Communication channels can be different, for example, satellite communication, optical communication or GSM, and also through radio channels or other special communication systems. It can also be the duplicated different types of communication.

The third stage is the online transfer of the data from a central database to the Scientific Research Center for Forecasting the Earthquakes SRC FE. In SRC FE the analysis of all data and the forecast of earthquakes is analyzed.



**Fig. 3. Structure of the process of earthquake forecast management**

The earthquake forecast is divided into five categories, depending on the level of accuracy of the various forecast parameters. As an example we give the following categories:

The first category includes:

1. The coordinates of the epicenter with a radius of the area 25 km;
2. Earthquake with  $M > 8$
3. The strength of the earthquake with an accuracy of magnitude  $M \pm 0.5$ ;
4. Time of the earthquake with an accuracy to one day;
5. The number of earthquakes indicating the magnitude of each shock  $M \pm 0.5$ ;
6. Probability of the forecast is  $> 90\%$ .

The second category includes:

1. The coordinates of the epicenter with a radius of the region 50 km;
2. Earthquake with  $M > 7$ ;
3. The strength of the earthquake with an accuracy of magnitude  $M \pm 0.7$ ;
4. Time of earthquake with an accuracy of two days;
5. The number of earthquakes with the magnitude of each shock  $M \pm 0.7$ ;
6. Probability of the forecast: 80% - 90%.

The third category includes:

1. The coordinates of the epicenter with a radius of 75 km;

2. Earthquake with  $M > 6$ ;
3. The strength of the earthquake with an accuracy of magnitude  $M \pm 0.7$ ;
4. Time of earthquake with an accuracy of two days;
5. The number of earthquakes with the magnitude of each shock  $M \pm 0.7$ ;
6. Probability of the forecast: 75% - 80%.

The fourth category includes:

1. The coordinates of the epicenter with a radius of the region 100 km;
2. Earthquake with  $M > 5$ ;
3. The strength of the earthquake with and accuracy of magnitude  $M \pm 1$ ;
4. Time of the earthquake with an accuracy of three days;
5. The number of earthquakes with the magnitude of each shock  $M \pm 1$ .
6. Probability of the forecast: 70% - 75%.

The fifth category includes:

1. The coordinates of the epicenter with a radius of the region of 150 km;
2. Earthquake with  $M > 4.5$ ;
3. The strength of the earthquake with an accuracy of magnitude  $M \pm 1$ ;
4. Time of earthquake with an accuracy of one week;
5. The number of earthquakes indicating the magnitude of each shock  $M \pm 1$ .
6. Probability of the forecast: 65% - 70%.

Depending on the category of the received earthquake forecast, the state emergency situations management agency makes five possible decisions, which are regulated by the relevant state standard and the law. As an example of decision-making, we give an example.

#### **Decision-making when obtaining the forecast of the first category:**

- Total evacuation of the population from the potential risk zone;
- Disconnection or going to the emergency mode of the hazardous industrial facilities - enterprises of the nuclear industry enterprises, chemical and petrochemical industry, etc.;
- Bringing into high alert: the rescue services; hospitals and emergency services; police; fire protection services; communication systems; public utilities; health service; preparation of the water supply and power supply service for connection to backup sources of power and water supply; public transport services for the evacuation of the population from the zone of potential danger.
- Giving the necessary information to the public about evacuation routes and other rules of operation, using all communication systems: loudspeakers, SMS,

e-mail, the Internet, radio and television broadcasts and other means of communication.

***Decision-making when obtaining the forecast of the second category:***

- Partial evacuation of the population (women, children, disabled, sick and old people) from the potential risk zone;
- Going to the emergency mode of hazardous industrial facilities - nuclear industry enterprises, chemical and petrochemical industry enterprises, etc.;
- Bringing into high alert: rescue services; hospitals and emergency services; police; fire protection services; communication systems; public utilities; health service; preparation of the water supply and power supply service for connection to backup sources of power and water supply; public transport services for the evacuation of the population from the zone of potential danger.
- Giving the necessary information to the public about the rules of action, using all communication systems: loudspeakers, SMS, e-mail, the Internet, radio and television broadcasts and other means of communication.

***Decision-making when obtaining the forecast of the third category:***

- Warning the enterprise managers about the possible going of hazardous industrial facilities to the emergency operation mode - nuclear industry enterprises, chemical and petrochemical industry enterprises, etc.;
- Bringing into high alert: the rescue services; hospitals and emergency services; police; fire protection services; communication systems; public utilities; health service; preparation of the water supply and power supply service for connection to backup sources of power and water supply; public transport services for the evacuation of the population from the zone of potential danger.
- Giving the necessary information to the public about the rules of action, using all communication systems: loudspeakers, SMS, e-mail, the Internet, radio and television broadcasts and other means of communication.

***Decision-making when obtaining the forecast of the fourth category:***

- Prevention of public authorities about the possible transfer of hazardous industrial facilities -nuclear industry enterprises, chemical, petrochemical, etc., to the emergency operation mode;
- Warning the public authorities about the possibility of going into high alert: the rescue services; hospitals and emergency services; police; fire protection services; communication systems; public utilities; health service; preparation of the water supply and power supply service to connect to backup sources of power and water; public transport services for the evacuation of the population from the zone of potential danger.

***Decision-making when obtaining the forecast of the fifth category:***

- Warning the public authorities about the possible going of hazardous industrial facilities - nuclear industry enterprises, chemical, petrochemical, etc., into the emergency operation mode;
- Warning the public authorities about the possibility of going into high alert: the rescue services; hospitals and emergency services; police; fire protection services; communication systems.

The above-given example can be considered as one of the options that demonstrates the distribution of decision-making by the state emergency authority, depending on the category of the received earthquake forecast. The creation of a national government system for management of earthquake forecasts leads to the necessity to adopt the appropriate laws regulating each stage of the made decisions, the criteria and the level of responsibility of those involved, both in the process of providing of the earthquake forecast, and in the process of taking the security measures and reducing risks in obtaining an official earthquake forecast. The law should take into account that the providing of earthquake forecasts is a scientific task and this process can be affected by unforeseen natural and technical factors. At the same time, the law will clearly coordinate the actions of all elements of the earthquake forecast management system.

## **Results**

The author has developed the main criteria for creating the earthquake forecast management system. The solution of this problem includes two main aspects: methodological guidelines for the providing of short-term earthquake forecasts and methodological instructions on the actions of the state emergency management authority in obtaining the forecast. These normative documents, according to the author, should be approved by the legislative body of the government as a single normative act with mandatory execution. In addition, the law adopted at the national state level will maximize the effectiveness of interaction of government agencies providing the earthquake forecasts and responsible for measures on reducing the risks and consequences of strong earthquakes.



## **Conclusion**

Creation of the Earthquake Forecast Management System EFMS will effectively solve the problem of introducing the short-term earthquake forecast in the countries located on seismically active territories.

## **References**

1. D.E. Alexander, "Towards the development of a standard in emergency planning". *Disaster Prevention and Management*, Vol. 14(2), 2005, pp.158–175.
2. D.E. Alexander, "Emergency and disaster planning," in A. López-Carresi, M. Fordham, B. Wisner, I. Kelman, & J. C. Gallard (Eds.), *Disaster management: International lessons in risk reduction, response and recovery*, 2013, London: Routledge. pp. 125–141
3. Crichton, M. T., Ramsay, C. G., & Kelly, T. (2009). Enhancing organizational resilience through emergency planning: Learnings from cross-sectoral lessons. *Journal of Contingencies and Crisis Management*, 17(1), 24–37.
4. R.W. Perry and M.K. Lindell, "Preparedness for emergency response: Guidelines for the emergency planning process," *Disasters*, 27(4), 2003, pp. 336–350.
5. P.A. Monakhov, Formulation of the concept of "emergency situations management." *Civil Security Technologies*, Vol. 13, No. 2 (48), 2016, pp.44-47.
6. U.I. Yamalov, "Modeling of management and decision-making processes in emergency situations," Moscow, Laboratory of Basic Knowledge, 2003, 288 p.
7. E.N. Khalilov, "Earthquake prediction method and device for the implementation thereof," World Intellectual Property Organization (WIPO), Geneva. 2013, WO 2013/096997 Eurasian Patent 018373.
8. E.N. Khalilov, V. I. Starostenko, A. V. Kendzera, A. Muba-rak, M. Qaisar and R. Sjamsinarsi, "Global gravitational effects before and after strong M8.9 JAPAN earthquake of March 11, 2011," *Proc. Int. Congress. Natural Cataclysms and Global Problems of the Modern Civilization*, Istanbul, Sept. 2011, pp. 57-69
9. E.N. Khalilov, "Global network of forecasting of earthquakes. New technology and new philosophy," London. SWB, 2009, 65 p.
10. Weather forecast history. <https://habrahabr.ru/post/179687/>
11. How does the Tsunami Warning System work? [http://www.tsunami.noaa.gov/warning\\_system\\_works.html](http://www.tsunami.noaa.gov/warning_system_works.html)
12. The Tsunami Warning System in the Pacific Ocean is 50 years old. <https://ru.unesco.org/node/250172>

## **HEAT TRANSFER ANALYSIS OF LARGE ARCH DAMS RESPECTIVE TO ETTRINGITES AND ALKALI SILICA SLOW REACTION**

**Smiljkovic Zika**

*Dipl. Eng. Beograd, Serbia, PM ASCE,*

*e-mail: [zikas@beotel.rs](mailto:zikas@beotel.rs)*

### **Abstract**

We will be discussed here the Heat Transfer Analysis of Large Arch Dams in conjunction of Ettringites and Alkali Silica Slow Reaction. We tend to emphasize the fundamental heat analysis of arch dam, as a matter of essence. (1) Here, the focus is to determine temperature field as long as to get the associated thermal stresses. This two-step procedure is temperature influences imposed the stress, but stress has no influence to temperature. Heat flows, within concrete and rock mass, by conduction. Heat is transferred to or from a solid body, by convection of adjacent fluid, convection by air and by radiation. Heat analysis induced the concrete solar radiation temperature towards 45<sup>0</sup>C. (2) According to Reference /2/ alkali solution in cement paste pores, attacks reactive minerals of concrete aggregate producing thus alkali silica gel which in presence of water swells. It is known as: Alkali Silica Slow Reaction (ASSR). The large arch dams water table, fluctuating during the sequence of time as variant procedure, use to drift dam gradually towards the reservoir during their life cycle. The ASSR transfer the concrete temperature to at least 60<sup>0</sup>C. (3) The Delayed Ettringite Formation (DEF) may cause expansion pressure to the hardened concrete, which can damage the tensile strength of concrete. On the other hand, the recrystallization of ettringite in the hardened structure, due to moisture changes may lead to structure damages because of the crystallization pressure and the increase in volume. The DEF implies the temperature of concrete up to at least 60<sup>0</sup>C. (4) There are several options on how we may inhibit the pathology of Heat Transfer, ASSR and DEF effects, to structural engineering and specifically, on large arch dams.

**Keywords:** *Heat transfer Analysis, ASSR and DEF of Large Underground Dams; January 15, 2018; Template File.....*

## **1. Introduction**

Compound dam-foundation model was taken to be appropriate for analysis of Large Dam Structures, originally designed or be rehabilitated. It was basically fragmented to concrete dam, and deformable rock mass. Concrete material was taken to behave according to common linear elasticity law. The elasticity model of concrete was justified on the ground of the maximum principal stresses evaluated in dam body which do not exceed the limit of proportionality. Concrete block joints (where modelled) were assigned the role of cohesive interaction while sliding. Consequently, they contain geometrical non-linearity. In conclusion, the dam – foundation compound model is taken as linear and elastic due to concrete material, while it is simultaneously possessing geometrical inelasticity due to concrete joints. The supporting rock mass was modelled according to Coulomb-Mohr failure (plasticity) criterion. The prevalence of vertical tectonic compressional regime of the rock including the large dam structure, the thin surficial weathering impacts then a number of joint sets belonging to several conjugate pairs, made the rock mass estimated as low jointed. The rock mass was estimated as medium i.e. absolved from faults, shearing zones and unstable rock wedges. As such, the semi-broken rock mass was completely neglected, and the same was modelled as a quasi-continuous and isotropic material too.

Under the circumstances, and since the supporting rock constituting the pretty large rock below the dam, it can be crossed with little defective material and then, to be modelled as discontinues arrangement medium. It was the case of for large dam structures, supposing they are settled quite homogenously on the supporting rock. The 3-D computational model discretized into finite elements, was serving as prototype for analyzing dam behavior. The prototype was processed with ABAQUS S6.13-4software.

## **2. Concrete and Rock Mass Heat Analysis**

Now we can incline to fundamental heat analysis of arch dam, as a matter of essence. While stress analysis, heat transfer calculations are applied to concrete in order to determine a temperature field, so that associated heat stresses may be defined. Rock mass used to be the conduction of the heat accumulated trough dam. It is to utilize appropriate FE mesh for temperature calculation and stress analysis for a dam by instructing software to transfer computed nodal temperatures to subsequent stress analysis. This two-step procedure is suited to the common case when coupling is sequential, that is, when temperature influences stress but stress has practically no influence on temperature. Heat flows within concrete conduction. Heat is transferred to or from a dam by convection of adjacent fluid, convection by air and by radiation. In a

mathematical model of heat transfer, the conduction across a boundary is respectively analogous to the stress analysis loads of surface traction and body force. /2/

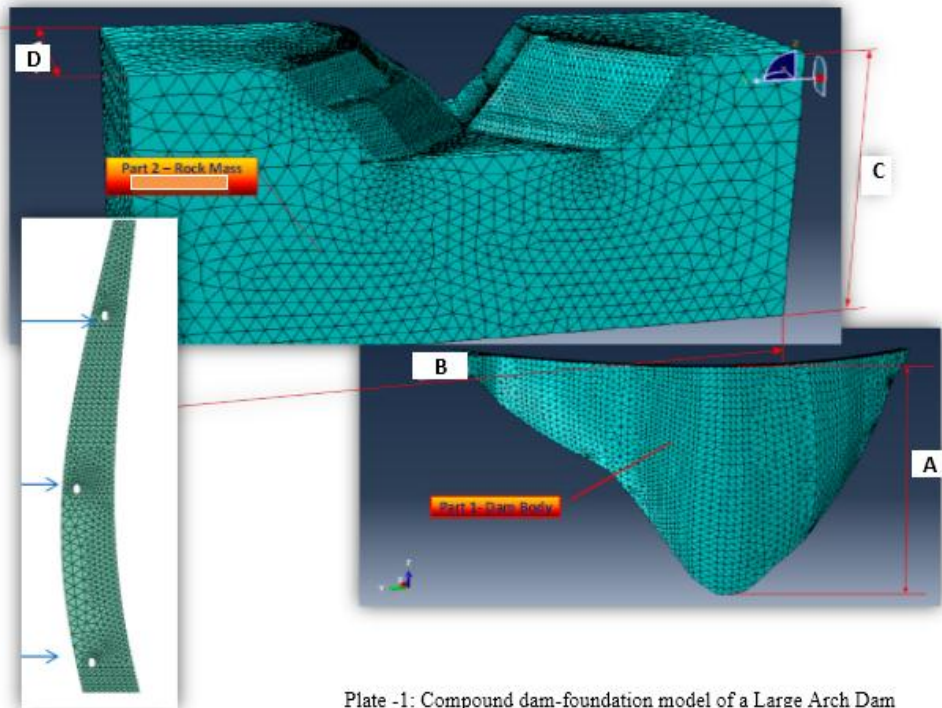


Plate -1: Compound dam-foundation model of a Large Arch Dam

**Fig.1. Compound dam-foundation model of a Large Arch Dam**

Correspondingly, there are two consequences of heat of dam transfer: (1) the thermal analysis of large arch dams and (2) the solar radiation of dam. The (1) are air temperatures and reservoir temperature, and under (2), solar radiation who can have significant effect on structural responses of the whole dam body. Meyer and Mouvet investigated heat behavior of a concrete gravity dam in Switzerland utilizing finite element method. Solar radiation increases the whole dam's temperature of about 4°C and the upstream water could regulate the temperature fluctuation amplitude. Conductivity and other thermal properties of a compound dam may be functions of temperature, just as elastic moduli may be temperature-dependent. Temperature-dependence does not make a stress analysis problem nonlinear, but *does* make a heat conduction problem nonlinear. A heat conduction problem is *certain* to be nonlinear if

there is a radiation boundary condition because the associated heat flux depends on the difference of fourth powers of absolute temperature rather than on simple temperature differences. The heat transfer problem we consider is that of determining the temperature field in a dam when physical properties are known and boundary conditions are prescribed. The temperature field may be steady-state or it may be transient, in which case we must determine the field as a function of time. In FEA, prominent matrices are a conductivity matrix which is analogous to a stiffness matrix; and a heat capacity matrix, which is analogous to a mass matrix. Primary unknowns are nodal temperatures. Heat flux, if desired, is obtained from temperature gradients. /2/ In general, the following names to matrices and vectors defined in heat transfer and note their analogues in matrices used in structural mechanics: frequently used in further application of heat transfer are as follows: (1) In the SI system the unit of heat is the same as the unit of energy, namely the joule:  $1 \text{ J} = 1 \text{ N}\cdot\text{m}$ ; (2) The unit of power is the watt:  $1 \text{ W} = 1 \text{ J/s} = 1 \text{ N} \cdot \text{m/s}$ ; (3) Temperature units are kelvins; degrees Celsius may be used instead unless radiation is involved ( $^{\circ}\text{C} = \text{K}-273$ ).

<b>Mat</b>	<b>Descriptive name</b>	<b>Structural analogue</b>
<b>[k]</b>	Conductivity matrix	Conventional stiffness matrix
<b>[h]</b>	Boundary convection	Elastic foundation stiffness matrix
<b>[c]</b>	Specific heat (or capacity)	Mass matrix
<b>{r<sub>B</sub>}</b>	Heat flux vector	Nodal loads due to surface traction
<b>{r<sub>h</sub>}</b>	Boundary convection	(no direct analogue)
<b>{f<sub>Q</sub>}</b>	Heat generation vector	Nodal loads due to body force

As far as thermal analysis of large arch dams is concerned, we can differentiate both (a) air temperatures, (b) reservoir temperatures and, (c) solar radiation effect.

#### *Air Temperature*

Estimation of the dam site's air temperature usually depends on the data obtained from the nearest weather station. The following data are collected from weather station:

- daily mean temperature,  $T_i$ ,
- daily maximum ( $T_{\max}$ )<sub>I</sub> and daily minimum temperatures ( $T_{\min}$ )<sub>i</sub>,
- the maximum monthly mean temperature,  $T_{\max}$ ,
- the minimum monthly mean temperature,  $T_{\min}$ ,
- annual mean temperature,  $T_{\text{mean}}$ , and
- the highest and lowest recorded temperatures at the site.

(b) Reservoir Temperature

Heat Analysis Units			As advised by ICOLD, 2008 <sup>3)</sup>
<b>c</b>	specific heat	(J/kg*K)	0.850 – 1.15 kJ/kg °C
<b>f</b>	heat flux	(W/m <sup>2</sup> )	
<b>h</b>	convective heat transfer coefficient	(W/m <sup>2</sup> *K)	
<b>k</b>	thermal conductivity	(W/m*K)	2.6 to 2.7 [W/(m <sup>0</sup> C)]
<b>T</b>	Temperature	(K, optionally °C if radiation is not involved)	(7 – 9)x10-06 <sup>0</sup> C
<b>n</b>	Temperature of adjacent fluid outside the laboratory layer	(K)	
<b>t</b>	Time(s)	(s)	
<b>ρ</b>	Mass density	(kg/m <sup>3</sup> )	
<b>σ</b>	Stefan-Boultzman constant	(=5,670(10 <sup>8</sup> ) W/m <sup>2</sup> *K <sup>4</sup> )	
<b>a</b>	Thermal Diffusivity	a=k/γ*c	0.0040 m <sup>2</sup> /h

The empirical-analytical Bofang's showed that the proposed method is in good agreement with the recitation values from China reservoirs and can be used for other reservoirs with small changes in the parameters:

$$T(y, t) = T_m(y) + A(y) \cos\omega(t-t_o - \varepsilon),$$

where  $y$  is reservoir depth,  $t$  is time in day,  $T(y, t)$  is the reservoir temperature at time  $t$  and depth  $y$ ,  $T_m(y)$  is the mean annual temperature of the reservoir,  $A(y)$  is the amplitude of the annual variations in the reservoir temperature,  $\omega$  is the frequency

of temperature variations, and the parameters  $\varepsilon$  and  $t_0$  (as illustrated by the Authors) /1/.

*(d) Solar Radiation Effect*

Solar radiation, according its nature, leads to increasing of temperature at the exposed surfaces of the dam body and is a function of the slope, direction, and latitude of the surface with respect to sun.

The amount of the solar radiation received by an arch dam depends on a series of periodic seasonal changes. This variation is a function of different factors such as the height of the dam site above the sea level, surface directions relative to sun, surface slope relative to horizon, the region cloud cover, surrounding topography of the dam site, and the time of the year. According to the above definitions, the total amount of radiation absorbed by the surface can be calculated from the formula of  $I_t$  that is to be defined as follows:

$$I_t = R_b (D - D_d) + (D_d \frac{1 + \cos \beta}{2}) + (\rho_a D \frac{1 - \cos \beta}{2})$$

Where:  $D$  is total days that solar is radiated on horizontal surface on the ground,  $D_t$  is daily diffused solar radiation on horizontal surface on the ground, and  $\rho_a$ , is the diffuse reflectance coefficient of the surrounding surface, generally ground surface, and reservoir in issue of arch dams. Parameter  $R_b$  is a geometric factor and is defined as the ratio of direct radiation on the inclined surface to the horizontal surface.

The solar radiation has succeedingly undeniable role at creation of the non-uniform temperature distribution on the dam surfaces. It means that the temperature differences between some coincident nodes highly affected by solar radiation are about 6°C to 10°C for the most hot and cold month, respectively. In the arch dams, their own especial geometry leads to heat concentration at some areas even at the same elevation. For the reason, the location of Dez Dam (Iran) which is in northern of the earth and considering that the axis of the dam has a slight angle (about 6°) to the geographic south, the sun which is located in the southern glows to downstream face and leads to more heat concentration near the abutments and middle elevations.

### 3. Alkali Silica Slow Reaction (Assr)

Nowadays, one of irrecoverable arch dams' deformations is the one caused by alkali silica or carbonate slow reaction (ASSR) or (ASCR). According to Reference /6/ alkali solution in cement paste pores, attacks reactive minerals of concrete aggregate producing thus alkali silica gel which in presence of water swells. The gel then builds up within the aggregate fragments and swells causing thus expansion of concrete and cracking of surrounding cement paste.

The alkali threshold in concrete is reported to be 1% of the cement, by weight or 3-4 kg/m<sup>3</sup> of concrete. However, the long term tests and field studies showed that the threshold may be even lower, i.e. 1.5 kg/m<sup>3</sup> or less. In addition, the temperature of concrete, particularly that above 60°C can have additional effects to building up ASSR. In existing arch dams, it appears that apart from alkali supply from cement, the alkalis may be supplied by feldspar mineral which is present in aggregate and they may maintain ASSR for indefinite future.

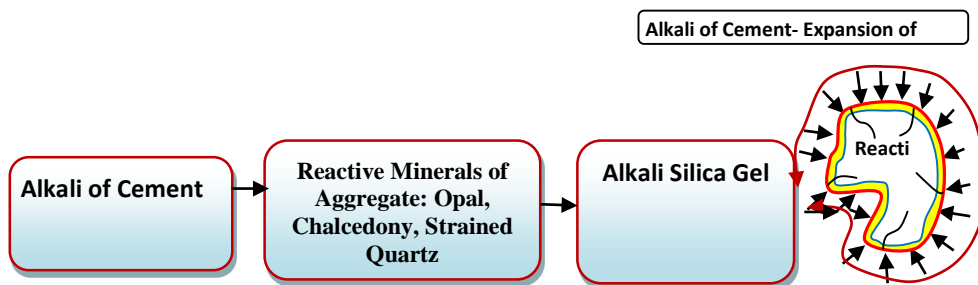


Fig.2. Flow chart of events that may cause ASSR behaviour of arch dams during their aging life

Besides the foregoing appraisals, there is the other lab and field investigations recognized worldwide which refer to either initial design of dams or, dam's rehabilitation. The **ASSR and ASCR** pathology of alkali-swelling process has not yet been fully understood but they could, according to explorations made National Council for Cement and Building Materials (India), /10/ be appraised as follows:

(A) They should be the **X-Ray Diffraction (XRD) Analysis**, the **Scanning Electron Microscopic (SEM) Study**, the **Alkali-Aggregate Reactivity test** and the **Petrographic Analysis**. While the first one (XRD) can be dealt with Ettringite



formation, the other two (SEM) and Alkali-Aggregate Reactivity test are to be addressed with alkali reaction.

(A.1) The **Scanning Electron Microscopic (SEM)** may identify the poor ASSR observed then, moderate one, or identified ASSR. Pending to identification of ASSR, their judgement can be guessed to be minor or well distinguished one.

(A.2) As for **Petrography Analysis**, the rock was to evaluate of from aggregate, from the dam depot the dam was constructed at the time. The Petrographic and Mineralogical analysis should be as per the IS: 2386, Part VIII or, as per similar research standards.

(A.3) **Alkali-Aggregate Reactivity Test** is a reaction in concrete between the alkali hydroxides, which originate from the Portland cement, and certain types of aggregate. Two types of AAR are currently recognized; these are alkali-silica reaction (ASSR) and alkali-carbonate reaction (ASCR).

The succeeding items may be relevant:

**(B) Field Studies**

**(B.1) Concrete Quality**

The UPV values in case of large dam structures should be varied between 4.0km/sec and 5.5 km/sec. When these values are compared with the velocity criteria of IS: 13311 (Part 1)–1992, the overall quality of concrete is assessed to be “Excellent” in general.

**(B.2) Crack Depth Determination**

The crack depth estimation whenever trough large arch dams were attempted using Ultrasonic Pulse Velocity (UPV) technique. The crack should be with no visual cracks or with the cracks of very minor opening and extrapolations for large arch dams.

**(B.3) In-situ Moisture Content using Humidity Meter**

The moisture content is one of the important parameter for corrosion process and for reactions like Alkali Silica Reaction (ASR) to occur.

**(B.4) Air Permeability Test**

Excellent long-term performance of concrete structures is associated with both concrete strength and durability properties, e.g., permeability which is a governing property to estimate durability of a concrete structure. Concrete durability is significantly affected by its permeability.

**(B.5) Ambient Temperature**

The ambient temperature be checked using Infra-Red Thermometer. The temperature for large arch dams of middle and far-east should be around the 15<sup>0</sup>C to 34<sup>0</sup>C.

**(C) Laboratory Studies conducted on Concrete Cores**

**(C.1) Compressive Strength**

The equivalent cube compressive strength was determined on hardened concrete core samples of 150 mm and 100 mm diameter for all the locations of an large arch dam in similar line as per IS:516. The average value comes out to an average equivalent cube compressive strength of **(a)** N/mm<sup>2</sup> and average corrected cylinder strength of **(b)** N/mm<sup>2</sup>.

**(C.1) Poisson's Ratio**

The Poisson's Ratio was determined on hardened concrete core samples of 150 mm and 100 mm diameter for all the large arch dam in similar line as per IS: 516 or similar standards. Therefore, for analysis purpose the overall average value of Poisson's Ratio considering 150 mm diameter concrete cores should be 0.25.

**(C.3) Modulus of Elasticity**

The Modulus of Elasticity may be determined on hardened concrete core samples of 150 mm and 100 mm diameter for all Arch Dam locations in similar line as per IS: 516 or similar standards. The variation in results of Modulus of Elasticity is generally may be due to presence of large size aggregates and lower diameter of concrete cores.

**(C.4) Split Tensile Strength**

The split tensile strength was determined by two methods: one in similar line as per IS: 5816 and other is in similar line as per IS:10082 (Brazilian Test) and the test results. The test was conducted on 150 mm diameter concrete cores.

**(C.5) Drying Shrinkage, Moisture Movement and Coefficient of Linear Thermal**

**Expansion**

**i) Drying Shrinkage:**

The Concrete core of 100 mm was then dried in an oven maintained at 50°C and relative humidity 17 % for 44 hours and then cooled for four hours. The 'initial drying shrinkage' or the 'drying shrinkage' was calculated as the difference between the 'original wet measurement' and the 'dry measurement' expressed as a percentage of the 'dry length'.

**ii) Moisture Movement:**

The moisture movement, the concrete cores were tested for initial drying shrinkage or drying shrinkage which were determined later. The cores were then immersed in water at 24 to 30°C in such a manner that one of the larger faces for each of the cores remains just outside water and were left so immersed for four days after which the 'final wet measurement' was determined.

### **iii) Potential Results:**

Counting on test results of drying shrinkage and moisture movement, it is seen that the drying shrinkage and moisture movement values in upstream portion of dam may be higher as compared to downstream portion. This indicates that there is chance of Dam undergoing differential shrinkage depending upon temperature, and humidity leading to stress generation.

#### **(C.6) Coefficient of Linear Thermal Expansion:**

Concrete Cores were tested in a saturated condition (immersed in water for at least 48hr before the starting of the test) and over the temperature range of 5 to 60 °C. Length determinations were conducted only when the specimens were in thermal equilibrium.

#### **(C.7) Creep as per ASTM C-512**

The creep test was conducted on 150 mm diameter and 300 mm length concrete cylinders which were taken from a number of locations of large arch dam i.e. at each gallery level in similar lines as per ASTM C-512. Based on the compressive strength obtained on the concrete core cylinders, the creep test is conducted at a stress of 40 percent of cylindrical strength.

### **Conclusions about ASSR, Field and Lab Studies**

Alkali-Silica reaction (ASSR) can acquire from colour test, petrographic studies, and scanning electron microscopy and to ascertain the degree of expansion mortar bar test as per ASTM C-1293.

On the other hand, Drying Shrinkage test results indicates that upstream portion of dam may be having higher moisture content as compared the downstream portion, what means that there is chance of Dam undergoing differential shrinkage depending upon temperature, and humidity leading to stress generation. As far as the Field and Lab Studies are concerned, they should be approximately the minimum as delineated in the table here to the left.

The unusual behavior of large arch dams has been stressed in terms of progressive irrecoverable upstream movement (towards the reservoir) of the central crest of dams and in terms of irrecoverable up- stream movement the upper dam body. Horizontal crack on the downstream face of the upper gallery location, are also symptomatic of unusual arch dam behavior. Study of ASSR warns of potential deformation becoming

critical at some point of time (period remain uncertain), underlying the needs for continuous dam behavior surveillance.

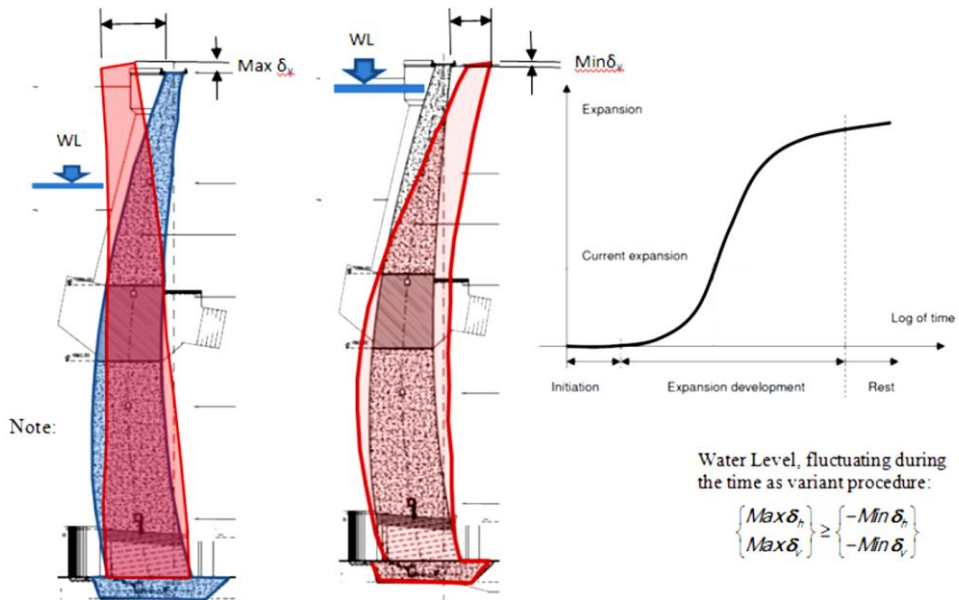
See Fig. 3 here with.

The ASSR has also presented important recommendation for priority actions and for remedying the dam behavior and mitigated of potential defects, if any. In addition, the temperature of concrete, particularly that above 60°C can have additional effects to building up ASSR. Meanwhile, epoxy resin injection of concrete cracks in conjunction of moisture repellents or injecting of carbon dioxide into arch dams under swelling, are some of the mitigating measures suggested by ACI 221.1R-98

Internal sulfate attack (ISA) can arise from sulfate provided by the aggregate or due to elevated temperatures (>70-80°C) during initial hydration. The latter is often referred to as delayed ettringite formation or DEF. The solubility of ettringite increases with temperature and with the concentration of alkalis in the pores solution.

Magnitude of Ratios		Recommended by ICOLD, 2008
Volumetric Weight, dry density of concrete	$\gamma$	0.0245 MN/m <sup>3</sup> (According to NCCB of New Delhi)
Compressive Strength of intact concrete material	$f_c'$	27.5 to 30.5 Mpa (Euro Code 2, $f_c' = 20$ to 30 MPa)
Tensile Strength of intact concrete material	$f_t$	2.7 MPa (According to NCCB of New Delhi)
Tensile Strength of rock mass - concrete joints	$f_{tj}$	$0.80*f_t$ Equivalent to $0.8*2.7 = 2.0$ MPa
Creeping of the Concrete: Creeping stresses level after which the concrete is expected to start creeping.		$(0.35 \text{ to } 0.40)* f_c'$ , whereupon creeping deformation increases
Sustained Modulus of Elasticity	<b>E</b>	$E = 25 \text{ to } 28 \text{ GPa}$ , $E = 9.1*(f_c'+8)^{1/3}$ , (Euro code 2)
Poisson Ratio of Concrete Material	$\mu$	0.17 to 0.20
Shear Strength of intact concrete material	<b>C</b>	$0.15*f_c'$ (=6.0Mpa)

### Delayed Ettringite Formation (Def)



**Fig.3. Central Cantilever of Large Dams with unproportioned  $\delta_h$  and  $\delta_v$  under the usual load conditions and with the application of ASSR and Ettringite**

Scanning electron photomicrographs show that ettringite ( $3CaO \cdot Al_2O_3 \cdot 3CaSO_4 \cdot 32 H_2O$ ) occurs in concrete in various forms, often as spherical clusters of ettringite crystals, felt-like or parallel needles of differing sizes. The form of ettringite crystals are those defined in Fig. 4. A characteristic feature of this type of damage is the conspicuous formation of ettringite in voids, cracks, and the contact zone between the aggregate and the hardened cement paste without any external sulfate attack having taken place. An ettringite formation in hardened concrete does not in every case lead to a direct damage of the concrete structure. The presence of ettringite crystals in the concrete is frequently equated with harmful ettringite formation. Apart from dry

climate, and if a concrete is exposed to alternating moisture conditions during use, then ettringite crystals can be detected in the voids already after a short time (6 months) without evidence of any serious impairment of the properties of the solid concrete. If the concrete has been heat-treated, the ettringite in pores and contact zones between aggregate and hardened cement paste is enhanced. In damaged concrete, ettringite is also to be found in the cracks. Therefore, it is necessary to clarify which processes in hardened concrete can lead to the observed accumulation of ettringite, and which mechanism makes „invisible“ ettringite visible. The correlations between the composition of the liquid phase in the hardened dam concrete and the existence and stability of ettringite seem to be the decisive influence.

The possible causes of accumulation of ettringite in the hardened concrete dam are as follows:

- additional formation of ettringite by internal sulfate release, e.g. from existing monosulfate or other sulfate-free phases, combined with transport processes, and

- mobilization of existing ettringite and/or its constituents, their transport and recrystallization (with grain growth).

According to Ludwig, /13/ these processes take place under the conditions of heat-treatment with subsequent moist conditions. But fairly high concrete temperatures can also occur during concrete placement under elevated external temperatures (summer weather), can be attributed to the use of hot cement and/or can be a result of the liberated heat of hydration which causes temperatures of more than 70 °C, especially in massive concrete elements. Similar processes may occur in concretes which have not been heat-treated but during use are exposed to temperatures above the stability limit of ettringite and to varying ambient moisture. The temperature of 60°C in concrete dams was found to be realistic under potential intensive sun-radiation by measuring the temperature in the downstream/upstream layer of dams. An application of the results from the investigations on the pore solution and of the investigations on the stability of synthetic ettringite in alkaline model solutions onto the real - system concrete, makes clear that in dam concrete with ongoing hydration development pH values, often exist in the solution phase under which the primary formed ettringite cannot be stable. Under this condition independent from risen temperatures, a decomposition of ettringite is possible so that ettringite can no longer be detected in the structure.

From the different theories on ettringite formation in hardened dam concrete, described in literature, possible damage mechanisms can be derived as follows:

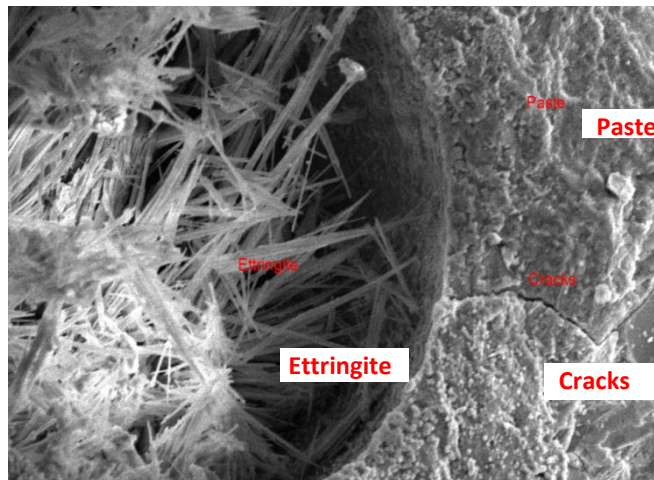
1. The primary ettringite formation during the initial hydration does not lead to damage, because this ettringite formation occurs in the plastic matrix and thus no

stresses will be produced.

2. If the ettringite formed primarily or delayed inside the microstructure is *micro-crystalline*, than in hardened concrete it may develop an *expansion pressure due to adsorption of water*, which can cause damages if the tensile strength of the microstructure is exceeded.

3. The *recrystallization* of ettringite in the hardened structure, due to moisture changes and accumulation of reactants, may lead to structure damages because of the *crystallization pressure* and the *increase in volume*. Suppose, the tensile stresses of concrete is over.

According to explorations made by National Council for Cement and Building Materials (India), the main of Ettringite analysis are of: **X-Ray Diffraction (XRD) Analysis**, the **Scanning Electron Microscopic (SEM) Study and the Petrographic Analysis**. **X-Ray Diffraction (XRD) Analysis** was carried out on the concrete core samples to determine their mineral composition of concrete. Minor or lot Ettringite, may be then defined there. The **Scanning Electron Microscopic (SEM)** may identify the Ettringite likely to continue, the cracks are mostly filled with ettringite, the ettringite crystals of size upto 10 microns observed in voids and at interfacial zones, and the ettringite (max 2  $\mu$ ) not profound and is in few voids only. As far as the ettringite is concerned, **Petrographic Analysis** there was point up to which ettringite might be sized-up. They were enlarged from 90 $\mu$ m to 1% up to ettringite dense of 3%. But further ettringite grains are noticed. The ettringite formation in the order up to 3 percent may not like to cause any expansion of concrete.



**Fig.4. An example of Scanning Electron Microscopy Analysis research by NATIONAL COUNCIL FOR CEMENT AND BUILDING MATERIALS, Delhi-Mathura Road, NH-2, Ballabgarh – 121 004 (Haryana).**

Summarizing the foregoing, the following can effect conspicuous formation of ettringite:

- DEF causes a characteristic form of damage - while the paste expands, aggregate does not. DEF swelling may not affect the properties of high concrete cement.

- If expansion causes cracking (e.g. ASSR), ettringite was coming later to form in cracks. Higher concrete temperatures could increase deferential voids volume, enhancing environment for development of ettringites in them. Potential intensive sun-radiation by measuring the temperature in the downstream/upstream layer of dams can increase ettringites formation.

- DEF does not in every case lead to a direct damage of concrete structure; it may cause only damage- promoting changes in the micro structure. The cracks emerge as a consequence of other damage mechanisms, e.g. mechanical stresses, shrinkage, or expansive reactions (ASSR).

- DEF effects more pronounced in high-grade concrete with high strength and low porosity.

- DEF and ASSR closely linked - ASSR is precursor for DEF. DEF is still by no means fully understood.

For fresh dam concrete, the ettringite formation can be restricted by latent hydraulic and/or pozzolanic additives which, combined with calcium (e.g. blast furnace slag, silica fume or fly ash from hard coal).

Field cases of heat induced delayed ettringite formation in in-situ concrete have arisen only when dam concrete with a high cement content ( $>400 \text{ kg/m}^3$ ) was cast in summer in large masses. The relatively high concentrations of sulfate ions needed to produce external sulfate attack are unlikely to be found in dams, except possibly in foundations and upper surface. However, even in such cases, this form of degradation is a progressive phenomenon, starting from the surface, with successive layers being degraded and disintegrating so it would not lead to massive expansion of the whole dam structure, except the cement content is excessive. This should be large arch dams seizing waterside of the canyon.

### **Retrospective On Expansive Reaction Of Large Arch Dams**

Assume, we have compound dam-foundation pattern of concrete large dam structure, which is to be rehabilitated, and which rock mass was defined as medium i.e. absolved from faults, shearing zones and unstable rock wedges. Neo-tectonic effects of rock mass are non-existent.



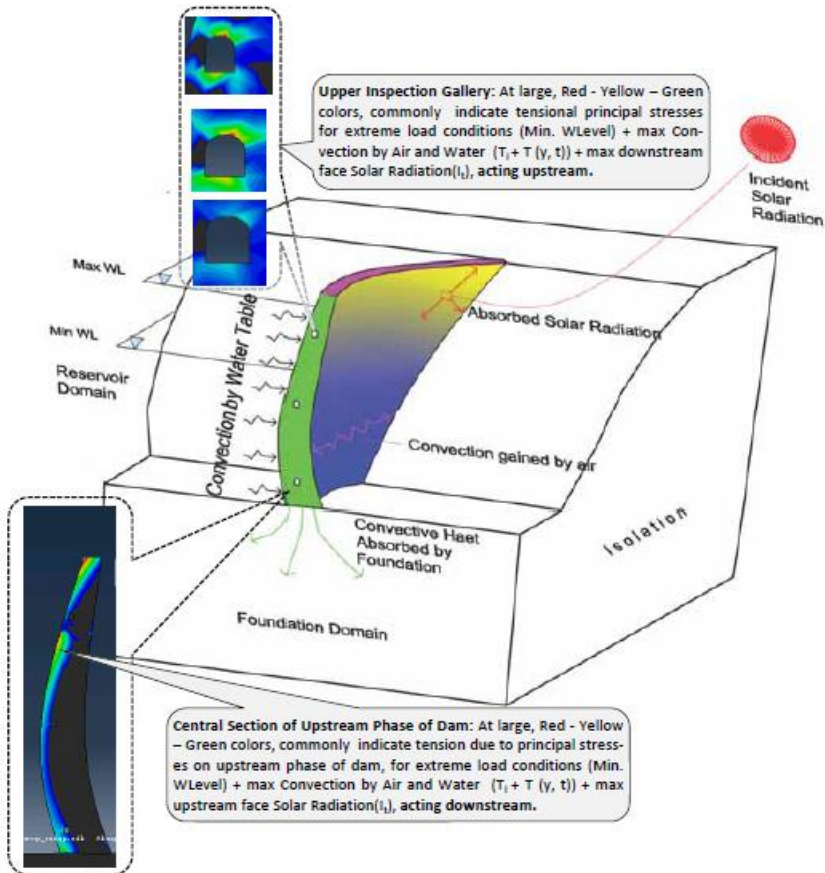
Creeping process in concrete and the extraordinary supporting rock loads seems to be eliminated. As for the loads, they are within the compressive and tensional stress and strength, of the concrete (service loads) and extreme loads due to radiation. Structurally wise, the large dam is behaving according to ICOLD recommendation 2008. The question is: What is progressing gradually during a year the upstream movement (towards the reservoir) of upper section of the arch dams? First of all, we should reevaluate stress analysis of the dam behavior for different load conditions, such as the water pressure (max and min WL), the sedimentation and unite-weight of dam. The bulk of dam section should be towards the downstream (from the reservoir) for max WL in case we should not be conducting the neo-tectonic effects or otherwise included. Secondly, the dam instrumentation including inter alia, pendulum devices installed in a number of vertical blocks, collimation of dam crest, and net-leveling of the area of the upper dam stretch and joint extensometers, should be involved in the dam surveillance. Monument triangulation should be included there as well. Apart from that, the 3D Terrestrial LIDAR Scanning SURVEY to survey the dam an accuracy of 2 to 5 mm should be necessitated as well. Extreme loads conditions due to earthquake are not relevant, simply because the annual progress movement of the dam is negligent. Suppose, the computation of large arch dams can be bring closer nearby, or can be near with all theoretical tolerance about stress analyses, then, the dams should be meant with heat analysis attributed with concrete (ASSR or DEF) expansiveness of dams. Usually it is configured as static extreme load for arch dams. The ambient temperature should reach approximately about 35<sup>0</sup>C and the solar radiation not less than 10<sup>0</sup>C. Along with that, the computation of dam potentially suffer from ASSR or DEF or, from their both, which can be amplified with heat problems of warmest annual periods. The hydraulic loadings, having being the greatest one of dams, while dam is exposed to seasonally cyclic load conditions, may change the stresses pattern there. In that case, the absorbed solar radiation in conjunction of air convection and convection by water table, they can have an undeniable role at creation of the non-uniform temperature distribution on the dam interior surfaces. While that and the min WL+ max downstream face solar radiation, the upper inspection gallery of a dam can usually be suffering tension stresses. See the Plate 6 for further explanation. As long as the min WL+ max upstream face solar radiation, the dam can be undergone the tension forces almost the over dam upstream phase. See the same Plate, too. The service load + tensional stresses due to heat effects should be not higher than  $0.3 \cdot 2.7 \text{ MPa} = 0.8 \text{ MPa}$  (8.0 kP/cm<sup>2</sup>) as prescribed by ICOLD (*Table 3*). Except they should be max 0.8 MPa, otherwise the result of which is concrete creeping, their heat temperature which is min 45<sup>0</sup>C, might be affective to ASSR and DEF (min 60<sup>0</sup>C), which potentially be in force. The effect of temperature on the kinetics of chemical reaction is well recognized and

was clearly verified by laboratory tests for concrete in expansive reaction. Here, the temperature dependency could also explain the greater expansion observed in the upper part (solar radiation one) relative to the lower part for arch dams which are thicker. **The upper thinner part of dams reaches higher expansive temperature which could reach to approximately 60°C (ASSR or DEF) versus the heat temperature being min 45°C.** In the event of the extreme load conditions, they might be stress-inflated by ASSR or DEF. Due to ASSR, the tensile stresses of the service load might be increased because of DEF + ASSR, which in total may overwhelm the stresses greater than 0.8 MPa as described by ICOLD. Thus, we can begin suffering irrecoverable dam behavior (towards the reservoir). In case the ASSR can be noticeable, epoxy resin injection of concrete cracks in conjunction of moisture repellents or injection of carbon dioxide into arch dams under swelling, are some of the mitigating measures suggested by ACI 221.1R-98. **The upper stretch of dam used to drift upstream (towards the reservoir)** while suffering cyclic annual load, and upon which, it could also be observed while a pattern of cracks in the event of the extreme load conditions, they might be stress-inflated by ASSR or DEF. Due to ASSR, the tensile stresses of the service load might be increased because of DEF + ASSR, which in total may overwhelm the stresses greater than 0.8 MPa as described by ICOLD.

Thus, we can begin suffering irrecoverable dam behavior (towards the reservoir) In case the ASSR can be noticeable, epoxy resin injection of concrete cracks in conjunction of moisture repellents or injection of carbon dioxide into arch dams under swelling, are some of the mitigating measures suggested by ACI 221.1R-98. **The upper stretch of dam used to drift upstream (towards the reservoir)** while suffering cyclic annual load, and upon which, it could also be observed while a pattern of cracks in the upper gallery and also by split-up cracks between the gallery and both concrete-rock joints. Fig. 3 delineates a layout of the typical time evolution of ASSR concrete expansion process. It is possible that the ASSR reaction become exhausted because of depletion of the reaction constituents (reactive materials and moisture). In case of supplementary source of alkalis from the aggregate, the completion of the reaction can take more time or even could not have an end.

The DEF referred to Delayed Ettringite Formation and hypothetically occur due to **elevated temperature** between the coarse aggregate/grains and paste of concrete. In hardened dam concrete it may develop an expansion pressure due to adsorption of water, which can cause damages if the tensile strength of the microstructure is exceeded. On the other hand, the recrystallization of ettringite in the hardened structure, due to moisture changes may lead to structure damages because of the crystallization pressure and the increase in volume due to tensile stresses. According to explorations made by National Council for Cement and Building

Materials (India), ettringite formation of order of 3 percent may not like to cause any expansion of concrete. The ettringite formation should be higher than 3%. Field cases of heat induced delayed ettringite formation of in-situ dam, which have arisen only when concrete with a high cement content ( $>400 \text{ kg/m}^3$ ) was cast in summer in large masses. However, even in such cases, this form of degradation is a progressive phenomenon, starting from the surface, with successive layers being demolished and disintegrating, **so it would not lead to massive expansion of the whole dam structure** save due to tensile stresses. This can be large arch dams seizing waterside of the canyon. DEF and ASSR are closely linked - ASSR precursor for DEF. The cracks emerge as a consequence of other damage mechanisms, e.g. mechanical stresses, shrinkage, or reactions precursor by Alkali Silica Slow Reaction (ASSR).



**Fig.5. Hypothetical stresses pattern around a large dam model for warmest period**

## Conclusion

For fresh concrete both the ASSR and DEF formation, can be inhibited by latent hydraulic and/or pozzolanic additives which is combined with calcium (e.g. blast furnace slag, silica fume or fly ash from hard coal). **As for irrecoverable (upstream) deformation of dams**, ASSR may be suppressed by epoxy resin injection of concrete cracks in conjunction of moisture repellents or injection of carbon dioxide into arch dams under swelling, are some of the mitigating measures suggested by ACI 221.1R-98. To the effect, overwhelming the tension stress reversal (*Max 0.8MPa*), may be induced by:

1. The **temperature** of arch dams for more than 60°C which in turn amplify their suitability for chemical reaction dams (ASSR and DEF), which both of them can divert the dam upstream, and
2. **Solar radiation in conjunction with convection by air and by water**, (*Min WL + max Convection by Air (T<sub>i</sub>) + max upstream Solar Radiation (I<sub>t</sub>)*) which amplify temperature for more 45°C (T<sub>i</sub>+T (y, t) + I<sub>t</sub>), again **acting upstream** in relation to mean annual temperature. Solar radiation is to thinner upper part of dam, again diverted them to upstream. The (ASSR and DEF) temperature (more than 60°C) are feeding with solar radiation temperature (more than 45°C). It is possible that the ASSR reaction become exhausted because of depletion of the reaction constituents (reactive aggregates/grains and moisture in the paste). The same is from drying shrinkage and dryable moisture content on downstream dam section (downstream side), which is contingent to due to water table moistening and may be due to the ASSR and DEF. For both of them (ASSR or DEF), photovoltaic screen installed on crown of the existing arch dam could be beneficial for expansive reactions large dam structure, primarily because of diminishing the concrete temperature. The same is for whole upstream arch dam, which can be painted with reflective white paint. The gallery cracks, if any, should be low pressure grouted.

## References

1. H. Mirzabozorg, M. A. Hariri-Ardebili, M. Shir Khan, and S. M. Seyed-Kolbadi. Received on 28 August 2013. Research Article: Mathematical Modeling and Numerical Analysis of Thermal Distribution in Arch Dams considering Solar Radiation Effect. (003-471).
2. Robert D. Cook David S. Malkus Michael E. Plesha Robert J. Witt, University of Wisconsin-Madison. Concepts and Publications of Finite Element Analysis (003-475).
3. Draft for ICOLD Review, March 2008. Committee On Concrete Dams. The Physical Properties of Hardened Conventional Concrete In Dams.
4. Jochen Stark, Katrin Bollmann, Bauhaus-University Weimar / Germany. Delayed Ettringite Formation in Concrete. (003-494)

5. R.Charlwood, Robin Charlwood & Associates, Seattle, WA, USA Chairman, ICOLD Committee on Concrete Dams. K. Scrivener, Ecole Polytechnique Federal de Lausanne, Lausanne, Switzerland Editor, Cement and Concrete Research, Elsevier. Publications. Expanding concrete in dams — long term challenges. (002)
6. Francesco Amberg, Lombardi Engineering Ltd., Switzerland. Performance of dams affected by expanding concrete.
7. R. Leroy, Alpiq Suisse SA, Lausanne, Switzerland. L.I. BoldeStucky, Renens, Switzerland. J.-F. Seignol & B. Godart, Université Paris Est — LCPC, Structures and Bridges Department, Paris, France. Re-assessment and treatment-design of an ASR-affected gravity dam.
8. Javier Rodríguez, Patricia González, Francisco Martínez, and Joaquín Martí, Principia, Madrid, Spain. Concrete Swelling in Existing Dams.
9. Victor Saouma and Luigi Perotti. Technical Paper in ACI Material Journal. Constitutive Model for Alkali-Aggregate Reactions.
10. Centre for Construction Development and Research, NATIONAL COUNCIL FOR CEMENT AND BUILDING MATERIALS, Delhi-Mathura Road, NH-2, Ballabgarh (Haryana).
11. Dr. B. R. K. Pillai. Director CWC. Study of Current Arch Dam Behavior and Distress. Presentation of Study Results, 6th May, 2015.
12. T. Meyer and L. Mouvet, “Behavior analysis of the vieux-emosson arch-gravity dam under thermal loads”, Dam Engineering, vol. 7, 1996.
13. Ludwig, U., Heinz, D.: Einflüssen auf die Schadreaktion in warmebehandelten Betonen. Feischrift Baustoffe Aachen (1985), pp. 105-110.
14. Simulia Systems, 2015, India.
15. B. Pandya, Chairman, Central Water Commission, India. Date: 3 June, 2015.
16. Bosko J. Guzina, Analysing of Dam Behavior and Responses of Dams Built in Tectonically Active or Potentially Active Areas. Serbian Society for Large Dams, 1<sup>st</sup> Congress of Serbian Society, 16 – 19 Jun, 2008, Recreation Center Tara.

## **EARTHQUAKE FORECASTING BY GRAVITY VARIATIONS PRECURSORS RECORDED AT ATROPATENA SYSTEM**

**<sup>1</sup>Nabeel Ahmad, <sup>2</sup>M. Awais, <sup>3</sup>M. Shahid Riaz, <sup>4</sup>M. Irfan and <sup>5</sup>M. Qaisar**

*<sup>1,2,3,4,5</sup>Center for Earthquake Studies, NCP,  
Quaid-e-Azam University Campus, Islamabad, Pakistan*

The study of gravity anomalies in the perspective direction of short-term forecasting of earthquakes is the most important aspect of researches in the field of geodynamics. Recently, significant anomalies were observed not only near the epicenter, but also in the region very far from the epicenter before the occurrence of strong earthquake. Such anomalies in the epicenter region are known as “source precursor” and those far away from the epicenter as “field precursors” (Ma Zongjin,

1980). Such precursors have been noticed by different seismologists, ranging from behavioral changes in animals to changes in Lithosphere Atmosphere and Ionosphere. One of these types of earthquake precursor is due to changes in gravitational field and this is noticed as “field precursor” (Walsh and Rice, 1979). The variations in gravitational field may be stipulated by a number of geophysical and tectonic reasons (V.Khain and E.Khalilov, 2006 and E.Khalilov, 2007). These are i) Stress conditions of the earthquake preparation zone when approached to the critical level, it causes either squeezing/compaction of the rocks or stretching resulting decreases of their density. ii) The critical stresses in earthquake preparation zone causes active movements of fluids in the layers of the Earth and as a result either it increases or decreases the level of subsoil waters that has been observed in the shafts and bores before the occurrence of earthquakes. iii) When the stresses approach to a critical size, it results in mass cracking of rocks in earthquake preparation zone, which eventually causes breaking of rocks iv) High and low density area appears due to deformational processes arising in the central earthquake preparation zone before the occurrence of strong earthquake.

Probably, there are also other factors involved in changes of gravity, but all of them do not have large radius of range regarding earthquake preparation zone of strong earthquake. It is due to fact that this effect of changes of gravity, connected directly with the geodynamical processes in earthquake preparation zone, is observed in the radius from tens to thousands of kilometers from station of registration. The system ATROPATENA, designed to monitor such type of variations of gravity, one of such system is installed at Islamabad, Pakistan. The Global Network for Forecasting of Earthquakes (GNFE) includes its ATROPATENA stations in Baku, Azerbaijan, Yogyakarta, Indonesia and Istanbul, Turkey and number of other stations are yet to be installed on different parts of the globe. Current study is based on the analysis of one and half year (January 2010 to June 2011) anomalies registered at ATROPATENA Network and presented success of earthquakes forecast.

### **Atropatena System**

The ATROPATENA system Fig. 1 consists of two Torsion detectors to register variations in gravitational field in two horizontal directions – NS and EW and a gravimeter to detect the variation in vertical component of gravitational field. Two sets of small masses are attached at the end of two bars of low density material. These small masses and one vertical gravimeter are placed in a jar. The system of detectors is completely isolated, due to it's highly sensitiveness, from the environment by means of

vacuum and registered very weak displacements of sensitive elements of the system. The system is set in equilibrium by two heavy masses placed outside the jar, to eliminate the effect of any small changes in gravitational field, not related to any geodynamic phenomenon. As a whole the system ATROPATENA registers the variations of gravitation field in three perpendicular directions – X, Y, Z. Recording these variations is done by using laser beams and optical matrix. There are small mirrors attached to each bar and gravimeter. The displacement of the bars is noted by using laser beams directed on these small mirrors. The laser beams reflected from mirrors to the optical matrixes. Then these changes in positions are recorded by the sensitive cameras attached on back of optical matrixes. The analogue signals are then converted to digital form by software Power Graph is transferred to the computer for recording.

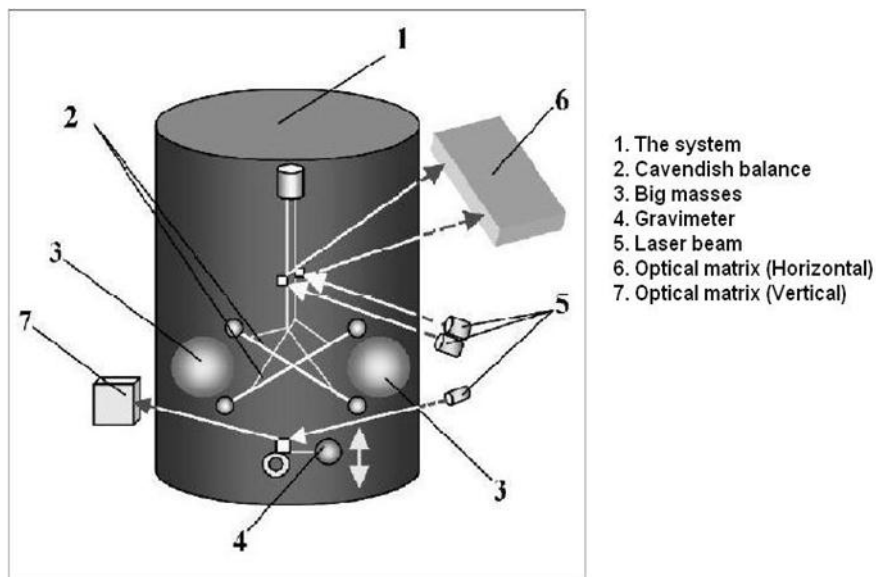
### **Data Recording And Uploading To Server**

These gravity variations signal generated before the occurrence of strong earthquakes are recorded at GNFE Network by seismic software after every 1-2 seconds. The recorded signals are then stored in Microsoft SQL server locally. After every ten minutes, the recorded data from the network is being uploaded to database server through TCP after automatic formatting as shown in Fig.2. The data is now available to download by using web site ([www.gnfedata.org](http://www.gnfedata.org)) and ready to analyze.

### **Data Acquisition And Analysis**

The acquisition of data is achieved by using the web site already mentioned above and detail description of how the data is uploaded from the GNFE Network. This data from January 2010 to June 2011 from ATROPATENA systems installed at Islamabad, Pakistan, Baku, Azerbaijan, Yogyakarta, Indonesia and Istanbul, Turkey were analyzed by using Power-graph software. The unusual Low-frequency changes in the gravitational field registered at the system were observed before the occurrence of strong earthquakes. This phenomenon was observed when the epicenters are at large distances (in the radius from one thousand to tens of thousands km) but we have taken

the radius  $\simeq 8500$  Km in order to ensure precise location from the registering station. There were some peculiarities during registration of signals, which allow the increase of accuracy of the forecast.



**Fig. 1. Schematic diagram of ATROPATENA**

The statistic of results shows that the gravitational signals were registered in 90% of cases, on the average 7-15 days before the occurrence of strong earthquakes. It is also observed “vibration of the record” – relatively high-frequency oscillations of gravimeter readings which is stopped right away after the earthquake. However, in some cases before the occurrence of distant strong earthquakes, the changes of anomalies of gravity have more complicated character. The anomalous signal registered on the ATROPATENA Network was analyzed on biannual basis starting from January-June 2010. The forecasts of earthquakes were made on the basis of arrival times that indicate the region of pending earthquakes. A total of 54 anomalies were recorded at the above said stations. 28 out of 56 were forecasted and successful forecasts were 22 on the basis of strong precursor gravity variations. Only six forecasts were unsuccessful. The statistical results of six months data reveal that the forecasts were successful about 77%. Similarly, pre-earthquake signals observed on ATROPATENA stations during next six months period from July to December 2010 were analyzed. Arrival times of anomalies on these systems indicate the region of pending earthquakes. A total of 104 anomalies were recorded during the period and out of these 84 were forecasted. 63 out of 84 were



successful forecasts were 63 and 21 forecasts were unsuccessful. The statistical results of six months data reveal that the forecasts were successful about 78%.



**Fig. 2. Network of System ATROPATENA**

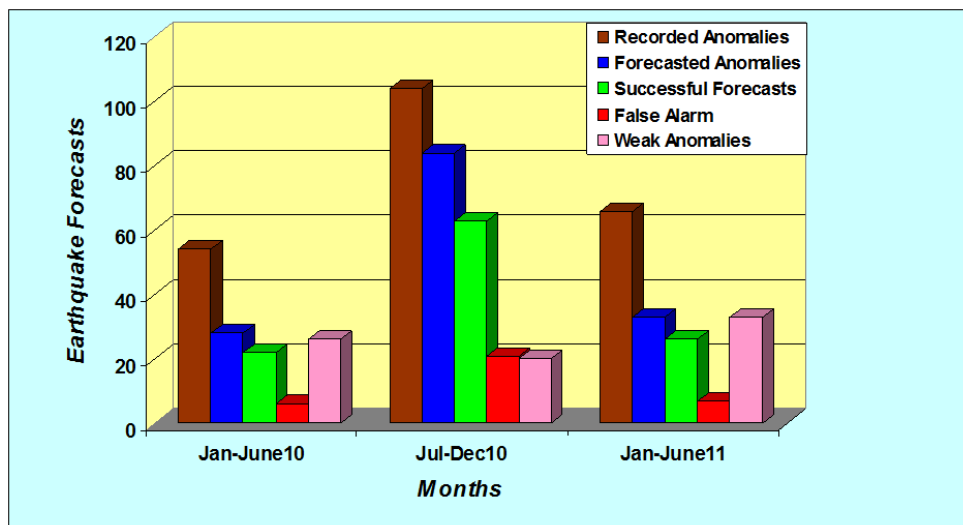
The Last six months January to June 2011 data was analyzed. A total of 66 anomalies were recorded and out of these 33 were forecasted. Out of 33 the successful forecasts were 26 and seven forecasts were unsuccessful. The statistical results of last six months data reveal that the forecasts were successful about 75%.

Table-1

**Showing Summary of Six months Earthquake Forecasts (Jan 2010-June 2011)**

Months	Recorded Anomalies	Weak Anomalies	Forecasted Anomalies	Successful Forecasts	False Alarms	Percentage of Success
Jan-June10	54	26	28	22	06	77 %
Jul-Dec10	104	20	84	63	21	78%
Jan-June11	66	33	33	26	07	75%
Jan,10– June,11	<b>224</b>	<b>79</b>	<b>145</b>	<b>111</b>	<b>34</b>	<b>76.6%</b>

The summary of analyzed data is shown in Table-1 and bar graph is shown in Fig.3. The result shows overall success ratios as 76.6% during period Januray-2010 to June 2011 which is good success ratio for the successful forecasting of earthquakes. However if we take into account the record from United State Geological Survey (USGS) there are large number of events as compared to anomalies registered at ATROPATENA in the study area. In fact this is due to less number of stations of GNFE network.



**Fig. 3. Graph Showing Summary of Six Months Earthquake Forecast (Jan 2010-June 2011)**

### Conclusions

The results of one and half year (Jan-2010 to June-2011) data show that anomalous signals recorded at ATROPATENA systems behave as precursors before the occurrence of major earthquakes. The data was analyzed and earthquakes were forecasted for different regions on the basis of arrival time of anomalies recorded on different stations. The forecasted earthquakes occurred in Indonesia, Japan, China, Taiwan, Central Europe, Iran, Pakistan and Hindu-Kush region of Afghanistan. The result indicates over all success ratios as 76.6% which is a good achievement for successful forecasting of earthquakes. However there is still need to supplement other geophysical data. The precise and successful forecast will be increased if more ATROPATENA stations throughout the globe are installed. The successful forecasting of earthquakes will help to save thousands of lives and properties from the natural

disasters.

### **Acknowledgment**

The authors are thankful to Dr. Ishfaq Ahmad N.I. H.I. S.I, for his constant encouragement and patronization of the project. The authors are also grateful to the Dr. M. Ahsan Mubarak S.I. for his guidance in preparation of this work.

### **References**

1. Khain V.Y. and Khalilov E.N. (2006). Tideless variations of gravity before strong distant earthquakes. *Science without Borders Volume 2 2006/2006 ICSD/IAS H&E*, Innsbruck, pp. 319-339
2. Khalilov E.N. (2007). About the possibility of creation of International Global System of forecasting of earthquakes “ATROPATENA” (Baku-Yogyakarta-Islamabad). *Natural cataclysms and global problems of the modern civilization. Special edition of Transaction of the International Academy of Sciences. H&E ICSD/IAS*, Innsbruck, pp. 51-69.
3. Khalilov E.N. The earth is universal detector of gravitational waves. *Proceedings of International Symposium: Cyclicity and cosmological Problems, 2-4 may 2003*, Pargulu, Y. Mamedaliyev settlement, pp.10-30.
4. Khalilov E.N. About possible influence of super long gravitational waves on duration of terrestrial day. *Proceedings of International Symposium*.
5. Khalilov E.N. About possible influence of gravitational waves on deformation and of the Earth seismicity. *Circular letter of Shemakha Astrophysical Observatory No.105, 2003*, p.13
6. Dikke R. Influence of variable in time of gravity interaction on solar system. In *Book Gravity and relativity*. M. Mir, 1965, p.251-294.
7. Braginskiy V.B., Ginzburg V.L. About possibility of measurement of dependence Gravitational constant on time. *DAN USSR*, vol. 216, №2, 1974 pp.300-302
8. Izmaylov V.P., Karagioz O.V., Parokhomov A.G. Researches of variations of results of measurements of gravitational constant. *Physical Idea of Russia No.1 -2 1999*, p.20-26.
9. Lyakhovets V.D. Problems of metrological provision of measurements of gravitational constant. *Problems of modern physics, Alma-Ata, Gylim, 1995*, 136 p.
10. Dobrovolskiy I.L. Gravitational precursors of tectonic earthquake. *Physics of the Earth, 2005, N 4*, pp. 23-28.
11. Levin B.V. Is the Earth core the conductor of seismic activity? *The Earth and the Universe. 2001, N 3*, pp. 12-19.
12. Mikhaylov V.O., Tikhotskiy S.A., Diaman M., Pane I. Researching of the Possibility of finding out and studying of variations of gravity of geodynamic origin on modern satellite gravimetric data. *Physics of the Earth. 2005. N3*, pp. 18-32.

## **THE RAPID PLIOCEN-QUATERNARY SUBSIDENCE OF SOUTH CASPIAN BASIN CAUSED BY SUBDUCTION OF ITS CRYSTALLINE BASEMENT**

**P.Z. Mammadov**

*Azerbaijan State Oil and Industry University, Baku, Azerbaijan*  
*parviz08@list.ru*

### **Abstract**

The South Caspian Basin is one of the deepest buried sedimentary basins in the world. It encompasses the entire deep-water, southern part of the Caspian Sea and adjacent onshore areas of Kura trough in the west and The West-Turkmenia trough in the east. According to opinions of majority of researchers (Zonenshine et al., 1990; Mamedov P.Z. 2008; Brunet et al., 2005) South Caspian Basin is a relic of Great Caucasus - South Caspian backarc marginal basin (GCMB) incipient during Middle- Jurassic time (Bajocian - Bathonian stages) on the active Meso-Tethys margin. It differs from the other deepwater land-locked and marginal basins of the world by a number of parameters. The South Caspian Basin has the thickest (6-8 km) ocean type solid crust (SC) and the thickest sedimentary overburden (25-32km) that is, characterized by the lowest longitudinal wave average (2.0-4.2km/sc) velocity, against 4.0-5.5km/sc in other sedimentary basins. In most sedimentary basins of the world a relationship between sedimentary succession/solid crust thicknesses appears to be around 0.8-1.2, whereas only in South Caspian Basin this ratio is measured around 3-4. Pliocene-Quaternary deposit thickness amounts to 10-12 km that exceeds 40% of sedimentary overburden deposited for the last 5.5 Ma. Herewith, thickness of the main hydrocarbon charged formation of Lower Pliocene, otherwise Productive Series - Red Color Series (5.1-2.6 Ma) amounts to 7-8 km. The time span when Productive Series- Red Color Series have been accumulated is less than 1/80 part of the basin total evolution history or almost 1-1.2% of Alpine cycle (180 Ma) duration in the region. Due to the rapid subsidence of the basin solid crust basin floor, porous Pliocene formations, dominantly sands/shales, have preserved its reservoir quality.

## **1. Introduction**

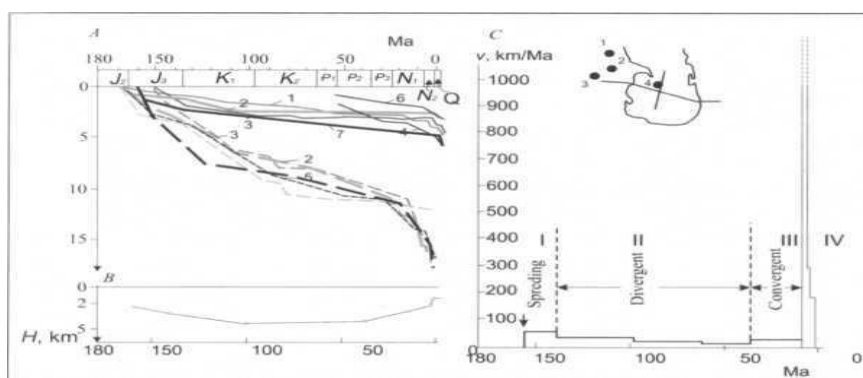
The South Caspian Basin originated within Arabic - EuroAsia collision zone is bounded by adjacent mountain systems like Great Caucasus, Kopetdagh, Talish and Alborz. On the north it borders with Skythian- Turan Epi-Hercinian platform. Geologic/geophysical studies indicate that South Caspian Basin is closely associated with region-wide and collision structural features. Rapid subsidence during Later Ce-nozoic time and post-Pliocene deformation are the primary challenges of the South Caspian evolution history. Evolution history of a basin requires restoration of a basement subsidence. Three key aspects of a sedimentary basin evolution involve: 1) tectonic motions of the earth crust that led to the relief formation to favor erosion and depositional processes; 2) eustatic sea level fluctuation (or relative sea level fluctuation); 3) rock erosion, se-diments transportation and their deposition.

Subsidence of a basement and sea level fluctuation generate accommodation space that could be filled by sediments. The way and rate of accommodation space are defined by depositional processes, and first of all by sediment influx.

### **1. Modeling Of South Caspian Basin Tectonic Subsidence**

Recently, South Caspian Basin subsidence history has been simulated by several geoscientists based on deep exploration wells spudded within the basin itself and on its margins, as well as on outcrop data. Subsidence modeling has been carried out with applied back stripping analysis (Stickler and Watts 1978). The main point of the method is as follows: if you know a position of a basement top or say of any other interface in a well or in outcrop you could subsequently “unload” or remove overburden of the overlying layers (that in its turn causes its ascending movement), taking into account sediment compaction while their burial. Overburden that exerts basement subsidence can be defined through proceeding from formation thickness and volume weight which alters while sediment burial compaction through time. In order to define basement occurrence depth (or any other interface) one might use well data, lithology, paleogeographic and paleotectonic as well as some other data (Guidish et.al., 1984). Back stripping analysis has provided curves reflecting basement subsidence history. They also enable to get some other characteristics. Most important of them is tectonic subsidence. It is common knowledge that basement subsidence is a result of two exerted factors –1) thermo-mechanical processes (endogenous factor) and 2) overburden force (exogenic factor). In order to calculate tectonic subsidence magnitude one should define what is the share of subsidence that falls on overburden. Overburden

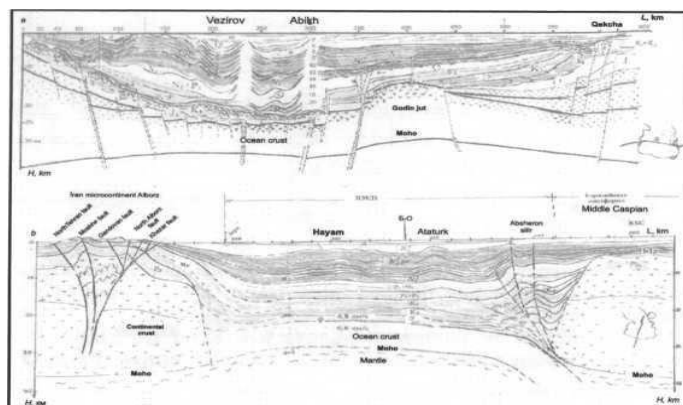
weight is supported either because of pushing out (or Archimedian) force effective at the lithosphere/asthenosphere boundary, or on the account of lithosphere resilience. P.Z. Mamedov (2008) have attempted to evaluate South Caspian Basin subsidence rate at various stages of its evolution and identify what had inspired the extremely rapid crustal subsidence during Pliocene-Quaternary time. Due to lack of data related to Jurassic deposit thickness and basement occurrence depth it was impossible to restore South Caspian Basin subsidence history starting from rifting incipient stage at the 80-90s last century. Therefore, quantitative subsidence modeling within the same onshore areas was carried out that time (Fig.1) where dominantly Jurassic deposits had been studied. These sites, according to restoration data were involved either in deepwater rifting graben of the Great Caucasus Sea or over its continental margin during Mesozoic time. Just within one offshore area (Shakh-deniz) (point 4 in Fig.1) well data has been used to study South Caspian Basin subsidence history. Sediment compaction parameters were calculated based on Bredtholm et al., (1988) data.



**Fig.1 Tectonic subsidence (solid lines) versus basement occurrence depth plot with bathymetry and rock compaction (dashed lines) taken in to account (A); bathymetry (B); tectonic subsidence rate (C): 1 and 2 - Great Caucasus SE plunge; 3 - Lower Kur-River trough; 4 - Shakh-deniz feature; 5 - South Caspian basin west margin; 6 - South Caspian basin; 7 - Generated curve for South Caspian basin.**

One of the most important challenges while modeling crustal subsidence is exact paleo-depth identification. Brunet et al., (2005) has accepted paleo-depth value to approximate 2.2-2.5 km (similar to recent marginal basins). These values tend to

increase with time up to 4.3-4.5 km depth during Middle-Later Cretaceous time due to both thermal subsidence and because of overall sea level rise. Further on, almost up to Oligocene time basin depth gradually reduced to 3.8 km depth due to its filling by sediments. During the collision stage of general transpression and detachment of land- locked proto-Caspian basin its depth diminished down to 300-900 m due to sediments influx with concomitant shelf slope formation.



**Fig. 2. Regionwide seismic-stratigraphic section along sub-latitudinal (a) and meridional (b) lines (Mamedov, 1991, 2006)**

Fig.1.a displays plots of tectonic subsidence and basement subsidence, caused by overburden and water column, as well as variation of bathymetry and tectonic subsidence rate. These plots has been compiled based on 1-D synthetic models-pseudo-sections for several sites, particularly for points 1 and 2 within Great Caucasus plunging site, point 3 within Lower Kur-River basin and point 4 - Shakh-daniz. Correlation of these pseudo sections Fig.2 has been carried out based on stratigraphic section compiled by author.

According to a general model Fig.1 compiled by P.Z.Mamedov (2008) who used seismi-stratigraphic section Fig.2 a) a newly generated of the GCMB during Later Jurassic time (165-145 Ma) had subsided down by 1.2 km at 59- 60 m/Ma rate due to extension and thermal subsidence process. Taking into account isostatic load of overburden and 2.5-3.5 km of water column it has been identified that total crustal subsidence approximates up to 6.0 km by Jurassic time termination. During Early Cretaceous time (145-97 Ma) basin crust subsided just by 0.9 km at 15-20 m/Ma rate only due to thermal subsidence. However making allowance for overburden and water column weight it was inferred that the earth crust was exerted additional

1.5 km of subsidence, so total subsidence approximates to 7.5 km. During Later Cretaceous time (97-70 Ma) the earth crust had subsided even more slower (10- 18 m/Ma) with tectonic component measured 0.8 km plus overburden exerted 1.5 km subsidence.

So, the earth crust of the basin had subsided just by 2.9-3.1 km and making allowance for overburden total subsidence amounts to 9.5 km. Seismic stratigraphic sections indicate that total thickness of Mesozoic deposit Fig.2 within Mid-South Caspian Basin does not exceed 4-6 km. This maximum thickness up to 8-10 km is observed within Absheron sill. It was identified that terrigenous deposits, even at shallow depth ranges (5-6 km), had undergone compaction of no less than 1.5-2.0 fold, whereas at 15-20 km depth almost 3 fold because of isostatic pressure and overburden (Guidish et.al., 1984). Sedimentary basin remained quite deep during Paleo-Eocene time (66-36 Ma) when its extension actually became suspended. Tectonic subsidence slowed down to 5-8 m/Ma. It is common knowledge that during first two evolution stages (rifting - arc- island extension) of the back-arc basin its crustal subsidence happened basically due to speculative assumption and acquired data about crustal subsidence of recent marginal basins.

Acquired data indicates that during Oligocene-Early Miocene time South Caspian basin crust underwent relatively slow tectonic subsidence due to increased overburden which thickness approximated to 14-16 km. That time the basin depth had gradually reduced due to extensive sediment influx. Later Miocene tectonic subsidence plots indicate an abrupt decline down to 2 km, whereas tectonic subsidence rate increased up to 600-2000 m/Ma.

Crustal subsidence range calculated for the northern part of South Caspian Basin near Absheron sill making allowance for overburden and water column value during Pliocene-Quaternary time makes significant value up to 10-12 km. Rapid cumulative crustal and tectonic subsidence along with paleotectonic backward analysis using region-wide seismic\stratigraphic sections of the basin subsidence within east Major Caucasus basin where its relic -South Caspian basin was incipient, enable to identify four basic stages Fig. 1,c. First spreading stage: Mid - Later Jurassic syn-rifting subsidence stage of marginal basin at the 50-60 m/Ma rate. The second divergent stage of arc Island extension (Cretaceous-Eocene) when marginal basin underwent slow thermal subsidence. During that stage the basin was filled by dominantly deepwater deposits (shale, carbonate shale, turbidites) along with condensed sheets

At the third convergent stage - transpressional stage (Oligocene-Miocene) when basin undergoes slow tectonic subsidence, crustal subsidence was exerted by the virtue of massive influx of terrigenous, basically shale sand overburden. The fourth

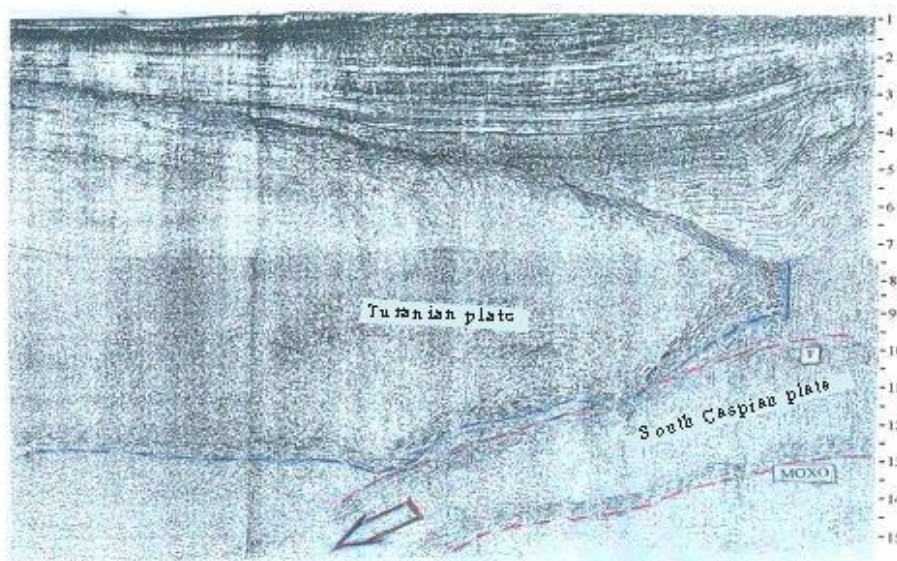


shrinking stage is the period of extreme rapid subsidence during Pliocene-Quaternary time when land-locked basins undergo transpression.

Subsidence rate within South Caspian Basin northern part at that Pliocene stage was 15-20 fold greater (600-200 m/Ma) compared to the rifting incipient stage and thermal subsidence of newly generated crust up to Cretaceous time Fig.1,b and by order of magnitude (100-200 fold) greater than during Cretaceous and Paleogene time. These figures are unique and in this regard South Caspian Basin has no alternative worldwide. Here, emerges one question, what kind of extraordinary geologic event might cause an abrupt and impressive subsidence during Pliocene Quaternary time? Standard models of tectonic subsidence even with overburden taken into account could not account for the cause of such rapid and extensive subsidence of South Caspian Basin crust during the last 5.5Ma. There have been several options related to this issue. One of them is rapid subsidence of both South Caspian Basin and Black Sea Basin associated with a "sudden" crustal subsidence along the bordering faulting systems during Pliocene time. However, there is no evidence of such faults existence observed on high-resolution seismic sections that might have caused 10-12 km deep crustal subsidence of South Caspian Basin during Pliocene-Quaternary time. There are convincing signs of subsidence accommodated deposition of Pliocene seismic unit with their mites and horizons thickness increment trend towards the basin center where total Pliocene thickness averages 6-7 km with its base subsided down to 10-13 km during that time Fig. 3. Due to the second option, basin subsidence is supposed to be driven by the solid crustal transtensional processes at recent time. Geodynamic condition of the region precludes resurgence of crust spreading and rifting subsidence of a solid crust and a relatively cool crustal blocks underneath the South Caspian Basin. Low heat flow and crustal neutral seismicity appears to have eliminated this option, too. Fair correlation of geological events that took place almost synchronously and unusually quickly rise and thrust of mountains, extreme reduction of dimensions of depression and abrupt subsidence of the bottom, extra-avalanche sedimentation) indicates to a strong geodynamic factor acting on the crust in the area of convergence of the plates. This factor induces unusual reaction of a thin-oceanic consolidated crust of depression. In the zone of contact of this crust with a thick continental crust of the platform, with different rheology and lithology, actions of colossal compressing forces from the south and huge isostatic load from above resulted in subduction that was a starting "pulse" for abrupt subsidence of sedimentary formations and subsequent events. Subduction of consolidated crust of depression is clearly seen on the models prepared with the use of data of ultra-deep seismometry (common depth point), seismotomography seismology and gravimetry (Fig. 4 and 5).

## **1. Analysis Of Feasible Reasons Of South Caspian Basin Rapid Subsidence**

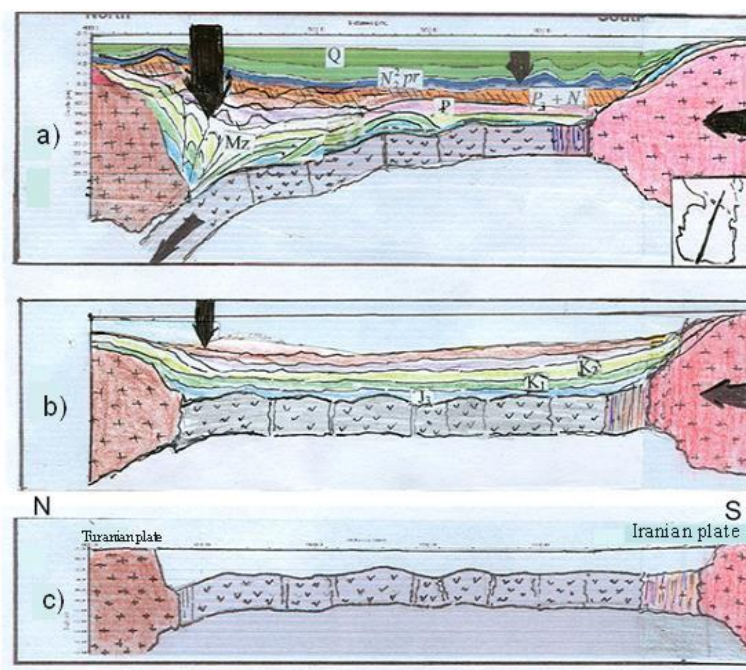
Brunet et al., (2005, 2013, 2013) consider one of the feasible causes of rapid subsidence during Pliocene-Quaternary time as bending effect of increasing transpression upon the basin lithosphere. The point of an offered mechanism is the effect of initial bending stage of elastic plate respond on external force similar to that of lithosphere as a whole. In order to calculate effective thickness of lithosphere along the basin longitudinal section a special algorithm has been used. South Caspian Basin lithospheric section has been simulated based on P.Z.Mamedov (2006, 2012).



**Fig. 4 The image of the Southern of ep-Hercynian platform and subducting / oceanic type crust of South Caspian Basin.**

Simulated South Caspian Basin overburden was assumed to be around 25 km thick, and a solid crust 10 km thick. Transpressional tension equating to the fold of 25 of typical interplate stress had caused just 2- 3 km subsidence. Such magnitude of South Caspian Basin crustal subsidence was sufficient to fill the basin with additional 2-3 fold of sediment influx (that is, in the range of 4-8 km thick, making allowance for sediment compaction and basin depth shallowing from 2.5-3.0 km depth in

Miocene down to 0.5-1.0 km during Quaternary time). Geophysical data acquired recently, from South Caspian Basin survey along with geologic/geophysical intelligence related to structural evolution of the region shed light on the basin rapid subsidence as a result of subduction process P.Z. Mamedov, (2005, 2012). According to some geoscientists Caucasus - South Caspian sector of AGPP is referred to the long lived subduction zones where Tethys and Meso-Tethys closure signs are witnessed. Intracontinental subduction zone in these segment has been traced based on region-wide seismic tomography data.



**Fig.5. Illustration of subsidence and subduction stages of SCB oceanic crust under the influence of geodynamic compression regime and the overburden pressure.**

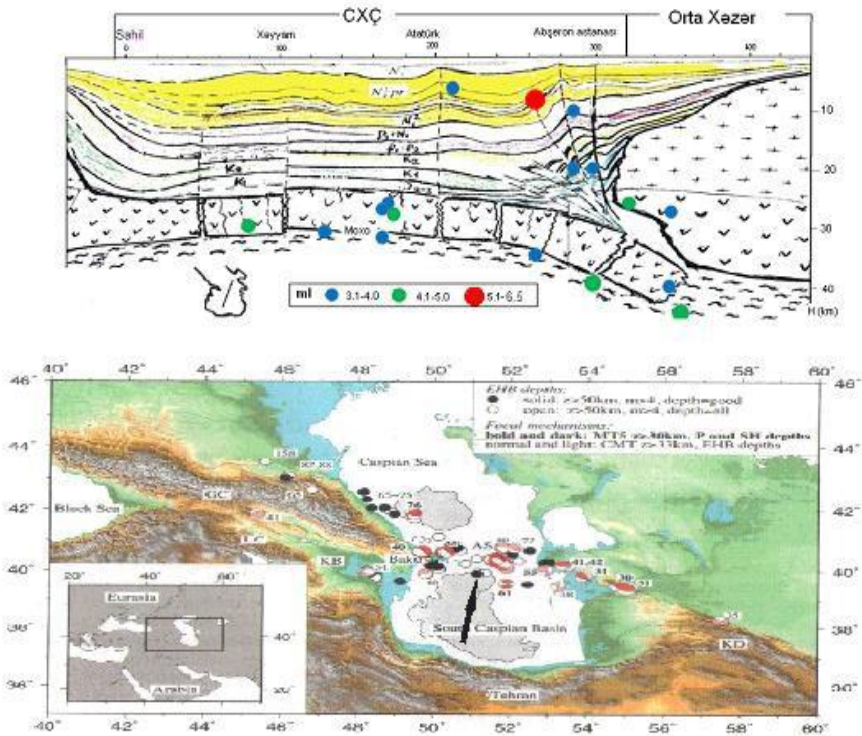
Zonen-shine et al., (1990) and others assume that South Caspian Basin and adjacent areas are precisely the areas where several ancient and recent subduction zones have been encipient and evolved. He considers that within the juncture of TransCaucasus and Euro-Asia plates during orogenic stage there appear to have generated an Amshtuts typte intraplate subduction zone slopping down to the north. According in P.L. Zonenshine et al., (1990) an extensive sive underthrust of Transcaucasul microcontinent had happened at 6-7sm/yr rate. The undertrust intensity

significantly decreased during Oligocene-Miocene and its rejuvenation resumed by Later Miocene-Early Pliocene. Was suggested that most subduction zones sloping down under Great Caucasus was kept live up to Quaternary time. Increasingly, subduction processes might have resumed within collision zone of South Caspian and Epi-Hercinian platform at the extremely trans-pressional stage. South Caspian solid crust subduction beneath the platform has been displayed in several sketches and models built up based on seismology, gravimetry (Granath et al., 2000), as well as a result of paleogeographic analysis.

Some of these concepts are very simplified and heuristic. Of all available South Caspian basin crustal models. Fig.2 **b**, 3 are justified based on actually reliable data of ultra-seismic long record Common Depth Point (CDP) data (16-20\sec) that provide picturesque information related to solid crust geometry, its thickness and geologic setting. A long record (CDP) reflection survey carried out over the conjunction zone, where South Caspian basin abuts Epi-Hercinian platform, has revealed that ocean type crust plunges down to the north with superimposed swell and a mosaic of basalt layer squash above (accretion prism), that along with other available data (gravimetry witnessing about deficit of dense masses, seismology supplying data about deep-seated earthquake focuses around Absheron sill) are the convincing arguments for South Caspian basin crustal subduction verification. Submitted subduction model is one of interplate tectonic models of the region evolution. Fig. 6 shows subduction oceanic crust of SCB and deep-seated earthquakes focuses around Absheron sill.

## **1. Conclusions**

That might be a result of extra ordinary event happened in the region that had been exerted by a strong geodynamic process as convergent of plates to cause the ocean crust respond within a contact zone will thicken continental crust of the platform with different lithology and rheology. Increasing transpressional stress exerted from the south and vertical force caused by overburden served as a threshold mechanism of the crustal abrupt subsidence and its subduction under the platform. It is just that very case when subduction might have caused abrupt sea floor subsidence at the Pliocene onset. Alternative geodynamic process enable to cause such interrelated even except subduction is unimaginable.



**Fig. 6. Illustration of subduction oceanic crust of SCB and deep-seated earthquakes focuses around Absheron sill.**

Good correlation of extra ordinary geologic events happened almost simultaneously in extremely rapid pace (extensive emergence o mountain systems, overthrust and diapirism, basin shrinking and rapid subsidence, avalanche sedimentation) during the last 5.5 Ma in the region witness that all these events had been entailed by the same geologic event, that is, a crustal transpression that triggered subduction and sea floor subsidence that was most extensive in its. Northern part. Modelling suggest that it is possible to account for the observed pattern of subsidence and sedimentation in the South Caspian Basin by a process of sediment loading and compaction on a thermally-subsiding, later Mesozoic crust. Analysis of earthquake focal mechanisms and epicenter depths show that the north ern margin of the basin, the Absheron Ridge is characterized by deep earthquakes at depths down to 90 km. These deep earthquakes have been interpreted to result from the subduction of South Caspian oceanic crust beneath the Absheron Ridge.

## References

1. Brunet M.F., Barrier R., Egans., Mamedov P.Z. (2005). "Tectonic and subsidence evolutions of the South Caspian Basin marines in Iran and Azerbaijan". Abstract book V International Conference "Petroleum geology and hydrocarbon potential of Caspian and Black Seas region", Baku, 87-89
2. Brunet. M.F., Ershov A.V., Mamedov P.Z., Kangarli T. (2013). "Mezozoic subsidence history of the Kura-Caspian Basin". Darius programme, Eastern Black-Sea- Caucasus Workshop, 24-25 June 2013. Tbilisi, Georgia
3. Brunet. M.F., Ershov A.V., Mamedov P.Z., Kangarli T. (2013). "Evolution of basins from Kura to Amu Darya". Darius programme. Central Asia workshop, 26-27 February 2013, Bonn-Company
4. Bredehoeft, J.D., Djevanshir, R.D., Belitr, K.R. (1988). "Lateral fluid flow in a compacting sand-shale sequence: South Caspian Basin". American Association of Petroleum Geologists Bulletin, Vol. 72, 416-424
5. Guidsh T.M. et. al. (1984). "Relationship between constatic sea level change and basement subsidence". Bull, America. Petrol. Geology.
6. Mamedov P.Z (2008). "Driving mechanism of South Caspian Basin Rapid Subsidence". Azerbaijan Oil Industry, Vol. 1, 7-19
7. Mamedov P.Z., Mamedova L.P. (2012). "Earth Crust Structure of The Southern and Middle Caspian Sea in the light of new seismic studies". The modern problems of geology and geophysics of eastern Caucasus and the south Caspian depression. 34th International Geological Congress, 251-258
8. Steekler, M.S., Watts, A.B. (1978). "Subsidence of the Atlantic type continental marigin off New York". Earth and planetary Science Letters, Vol. 41, 1-13
9. Zonen-shine L.P., et. al. (1990). "Tectonic of the litosphere plates of the USSR".
10. Books 1 and 2. Nauka, Moscow.

## LATERALLY DEVELOPED SEDIMENTATION OBJECTS IN THE SOUTH AND MIDDLE CASPIAN BASIN

P.Z. Mammadov<sup>1</sup>, R.Y. Ganiyeva<sup>1</sup>, P. Mammadova<sup>2</sup>

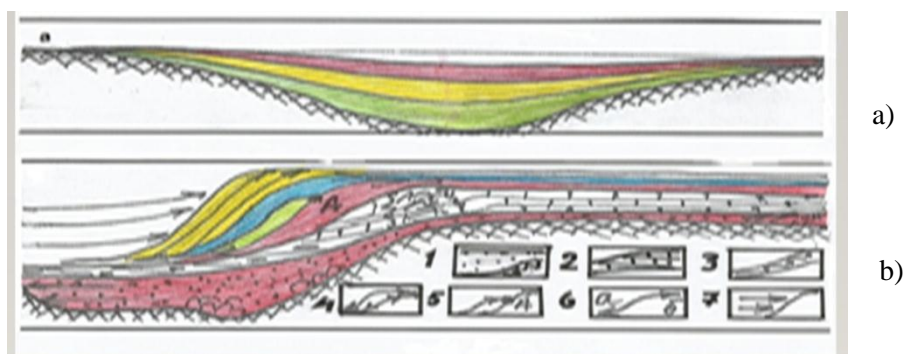
<sup>1</sup>Baku, Azerbaijan State Oil and Industry University

<sup>1</sup>Baku, Azerbaijan State Oil and Industry University

<sup>2</sup>Baku, SOCAR "OilGasScientificResearchProject" Institute

### 2.1. Genotypes and sedimentation environment of basins existed in the region

Geodynamic processes, tectonic motions and sea level fluctuations in the region generated various types of tectonic and morphological sedimentary basins. Seismic stratigraphy outlines two types of morphological sedimentary basins: deep water (uncompensated) basins and shallow epicontinental basins Fig.2.1.

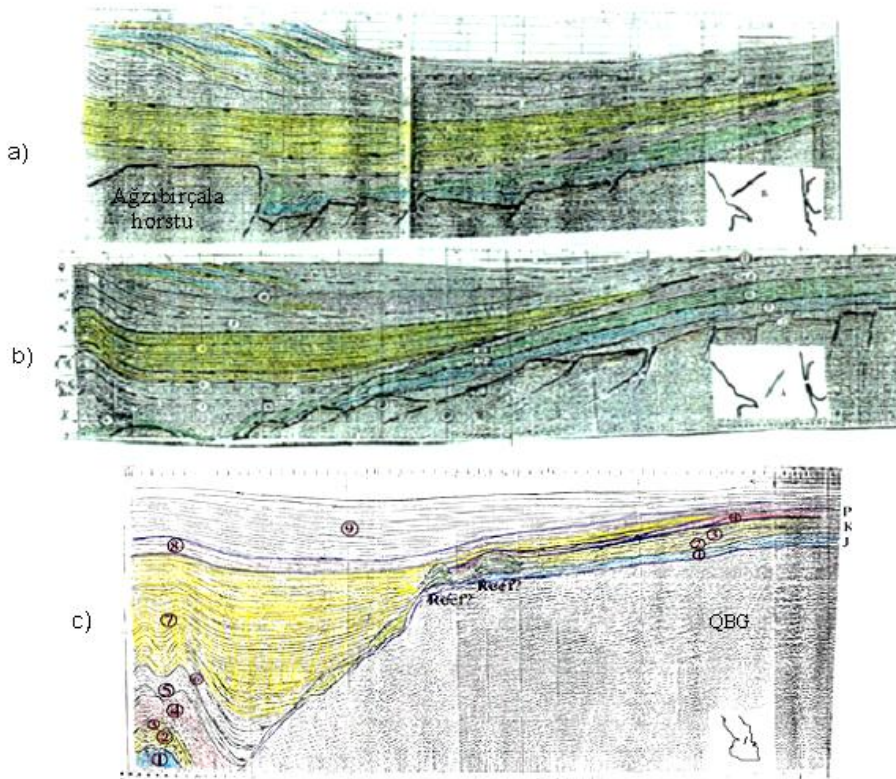


**Fig. 2.1. Morphological types of sedimentary basins:**

- a) shallow consedimentation epicontinental basin; b) deep-water uncompensated basin: 1 – laterally filled (reverse) clinoform; 2 – carbonate (direct) clinoform; 3 – depression sediments; 4 – progradation clinoform; 5 – layers onlapping the steep slope; 6 – laying over the foot (a) and top (b); 7 – onlapping the foot.**

The former are the basins recovered as a result of riftogenesis (horizontal stress and vertical sedimentation) and developed over the oceanic crust. In some cases they are named as “sedimentation traps” or “topodepression”. The latter are the basins developed over the platform or in intermountain areas (Shlizinger, 1998; Mamedov, 2009). Great Caucasus – South Caspian marginal sea outcropped as a result of riftogenesis in Jurassic extended and deepened to Oligocene and was not compensated by sediments. Despite subduction and tension started from Oligocene the marginal sea and its relict- the South Caspian Basin were an areas of constant subduction. Presence of terrigenous laterally accumulating sedimentary objects in the northern part of South

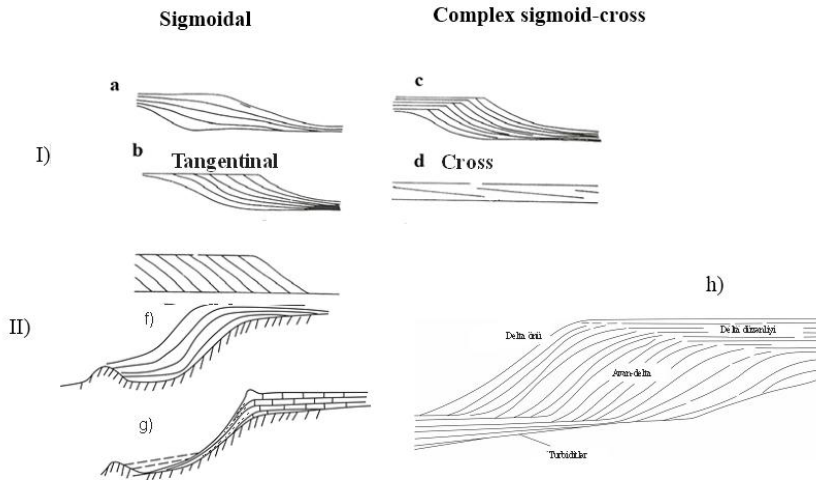
Caspian basin and fore-platform transition zones on continental slopes, as well as presence of carbonate clinoforms on shelf margins are evidencing deep water nature of this basin. Seismic stratigraphy makes it possible to outline lateral sedimentation (reverse clinoform), carbonate (direct) clinoform, progradation clinoform and depression sediments attributed to deep water seas existed in the South Caspian basin at various time periods **Fig.2.2.**



**Fig. 2.2. Image of laterally accumulated terrigenous and carbonate objects (sequences) in regional profiles**

Lateral sedimentation is generated by terrigenous material incoming from shelf, covering the bottom and relatively gentle slope ( $<10^0$ ) creating reverse clinoform. This sequence consists of gently-sloping parallel layers onlapping the slope foot.





**Fig. 2.3. Image of laterally accumulated sedimentary objects in seismic time sections**

- I) Scheme of laterally accumulated sedimentary objects;**  
**II) Progradation terrigenous clinoform (f), carbonate clinoform (g) and elements of deltaic sequence (h) covering continental shelf, slope and bottom.**

Carbonate clinoform is generated in areas with no erosion on passive shelves and far distance of sedimentation sources and replaced by depression facies at the foot of the slope. In case of abnormal amount of brought detritus the sedimentary sequence accumulated laterally on the gentle slopes creates terrigenous clinoform Fig.2.3. On relatively steep ( $>15^{\circ}$  -  $20^{\circ}$ ) slopes sediments brought from shelf serve as a transit along the slope and laterally cover foot of the slope. Progradation type clinoforms are observed also in areas far from avandelta and gentle slopes. Applying backstripping analysis for reconstruction of the South Caspian basin subduction to the large depths (Mamedov; 2008; Abdullayev, et al., 2001) and seismic stratigraphy analysis it has been derived that the South Caspian basin always was a deep-water basin.

At the divergence (extension) stage the depth was 3-5 km, at the convergence (compression) stage the depth was 2 -1 km. In both cases the basin was not fully compensated. It must be noted that even in the Early Pliocene basin considered as a shallow-water the deep-water lake existed in fore-Elbrus trough and deltaic and avandeltaic sediments were accumulating on its shelf and slopes due to sediments brought by large rivers (Paleo-Volga, Paleo-Uzboy, Paleo-Kur) and tens of small rivers. As a result, the lake was extended, however not fully compensated. Identification of seismo-facies units laterally accumulated and overlapping the slopes in Late Pliocene and Pleistocene in the central part of South Caspian are the pivotal indicators of the deep-

water basin presence in this area through all time periods. Clinoforms are generated by joint impact of sea level fluctuations and sedimentation rate, while they have poor relation with tectonics. Studies of laterally accumulated sedimentary objects makes it possible to derive comprehension of paleotectonic and paleogeographic sedimentation environment in the basin.

Paleotectonically these objects display uncompensated sedimentation mode of negative (subsided) relief. Paleogeographically these units by their form, configuration and dip of reflection surfaces allow to derive denudation areas locations, erosion direction, erosion basis and sedimentation areas. Finally, from oil and gas exploration point of view the clinoforms deserve the interest for prediction of coarse detrital and sand lenses presence.

## **2.2. The origin of laterally accumulated objects in various paleogeographic zones of continental margins**

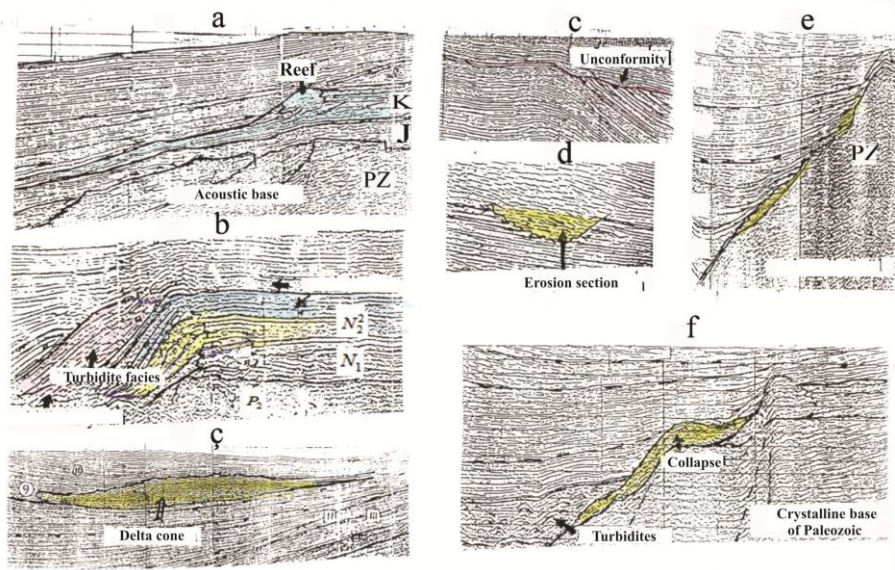
Seismic stratigraphy makes it possible to outline and map paleogeographic zones playing a major role in generation of sedimentation cover in ancient continental margins in Caspian section of Scythian-Turanian platform during Mesozoic and Cenozoic.

In highly informative seismic time sections of Middle Caspian the wide continental shelves (100-120 km) of Mesozoic –Paleogene basins the gentle ( $<1^{\circ}$  -  $5^{\circ}$ ) and relatively steep ( $>20^{\circ}$ ) slopes are reflected (Figure 2. 4). These shelves and slopes for a long period of time (from Late Jurassic to the Middle Miocene) were morphological and structural units of regional scale on continental margins of Meso-Tethys (Neo-Tethys) marginal sea.

In transition zone from the southern flank of Scythian-Turanian platform to the Alpien active zone several sedimentation units developed under the environment of sea level fluctuations and tectonic processes, they were limited by layer boundaries and unconformity surfaces: vertically developing (aggradation), laterally developing (progradation), accumulative, massive, sediments filling exogenic relief and faults.

In the South Caspian basin the clinoform type clastic sedimentary sequences are widely distributed. These evidence lateral infill by sediments brought from continental margin of deep-water basin. On seismic sections of sedimentary sequences of various age in Middle Caspian and South Caspian basins the laterally developing units can be clearly seen Fig. 2.4.

In these basins the laterally developing and clinoform sequences were identified in Paleogene (Oligocene, in particular), Miocene, Early Pliocene, Absheron and Quaternary deposits (Mamedov, 2008).



**Fig. 2.4. Fragments of time sections displaying lateral objects covered shelves (b,c,ch), gentle slopes (a) and steep slopes (e,f) and filled up the erosion sections (d)**

The real mechanism of terrigenous sedimentogenesis on continental margins is clearly displayed by flow-type sedimentation concept (Lisitsin, 1988). Modern concepts on eustatic and relative fluctuations of sea level gives us the logical explanation of huge amount of sediments in these zones. According to flow-type sedimentation concept while the low sea level the sediments are moved to the slope foot from deltas and shelves by water flow and dense flow (gravities). Deltas, shelves and slope foot are the major places where laterally accumulating sedimentation masses are developed. Seismic stratigraphy shows that in some cases the gentle continental slopes are areas favorable for generation of laterally accumulating objects. Marginal structures of Epi-Paleozoic platform in the Middle Caspian played an exceptional role in generation of sedimentary sequences of various age and laterally developing sedimentary objects of specific shape in sedimentary cover of South Caspian basin. In this respect, tectonic uplifts system at the margins of the platform (the western part of Karaboghaz dome, Aghzibirchala horst (Western Caspian uplift) and Yalama-Samur uplifts group) were the structures separating the epicontinental basins over the platform from deep-water Great Caucasus marginal sea during Late Jurassic, Cretaceous and Paleogene. These uplifts for a long period of time were the elevated elements of Paleozoic basement of the platform and underwent erosion. For instance, the Karaboghaz dome until the middle of Late

Cretaceous was the supplier of sediments to the deep-water basin on the south Fig. 2.2. According to well and seismic data the Aghzibirchala horst was the paleoland up to the Miocene Fig. 2.2a. Surfaces of these uplifts underwent denudation and evidence the erosion processes and flow activity. Partial enlargement of sedimentation basin and relative uplift of sea level caused the southern flanks of these uplifts transformation into underwater shelves and slopes. In the Middle Caspian the synphase axes location over the uplift flanks in form of onlapping is the most important indicator of sea level uplift in the Early and Late Jurassic Fig. 2.2, c. The sediments were transported by underwater flows from shelves to the deep-water basin in the south. Analysis of morphological features of northern near-flank structures of Mesozoic-Paleogene paleobasins in transition zone reflect that the zone corresponds to the classical model of continental margins of marginal seas in modern oceans. Here the specific features of transition from continent (platform) to deep-water marginal sea (the South Caspian basin as its relict after the Miocene) are the major indicators of the South Caspian basin being of marginal sea origin. Thus, transition structures of Epi-Paleozoic platform in the Middle Caspian play an exceptional role in generation of sedimentary units of various age and laterally developing objects of specific shape in sedimentary cover of South Caspian basin.

One of the major results of paleogeographical and facies analysis is the conclusion that sedimentary cover of high thickness (>20 – 25 km) was formed due to detrital and erosion materials brought mainly from the north – Scythian -Turanian platform and neighboring mountain ridges by river flows, mudflows and underwater flows.

In Mesozoic–Paleogene relatively small amount of sediments have been brought from the south, in particular from Elbrus, Talysh-Garadonlu and Saatly-Goychay islands arch. However, at the convergence (orogenic) development phase of the basin the huge amount of detrital material was brought from the surrounding mountain ranges (Small Caucasus, Talysh, Elbrus, Aladagh-Benalud). Laterally developing objects of various shape was represented by initial sloping and sigmoidal borders. These objects were primarily creating the huge masses of progradation type sediments. Sediments of high thickness (>27 – 30 km) were accumulated on the northern flank of South Caspian basin – at the threshold of Absheron-Balkhanyani (after closure of Great Caucasus and Kopetdagh segments of marginal sea in Miocene). On seismic sections they are mostly were traced in the northern flank of South Caspian basin - at the threshold of Absheron-Balkhanyani and adjacent areas. Mesozoic-Paleogene deposits of high thickness (~10 – 15 km) were uplifted and currently they can be identified at 1.0 – 3 km depths in some structures of North Absheron uplift zone (Absheron kupasi, Shargi Gilavar, etc.). A huge amount of sediment accumulation in the northern flank of South Caspian basin and uplifting of ancient (Mesozoic – Paleogene) deposits was previously supposed as related to geosynclinal processes in the region.

However, for the last years, based on interpretation of ultra-deep seismic data it

became obvious that in the northern part of South Caspian basin the major reason of complicated folding, high thickness and uplifting of Mesozoic-Paleogene deposits is cutting and deformation of sediments during subduction of oceanic type of crust in the basin and development of overthrust type structure within its accretionary wedge (Mamedov, Mamedova, 2012).

Seismic stratigraphic analysis of acquired data provides accurate data on laterally developing objects and tectonic and morphological elements in fluvial-deltaic zones of Middle and South Caspian, ancient continental shelves, slopes and slope foot. To study laterally developing objects in these paleogeographic zones the known diagnostic techniques of seismic stratigraphy are applied.

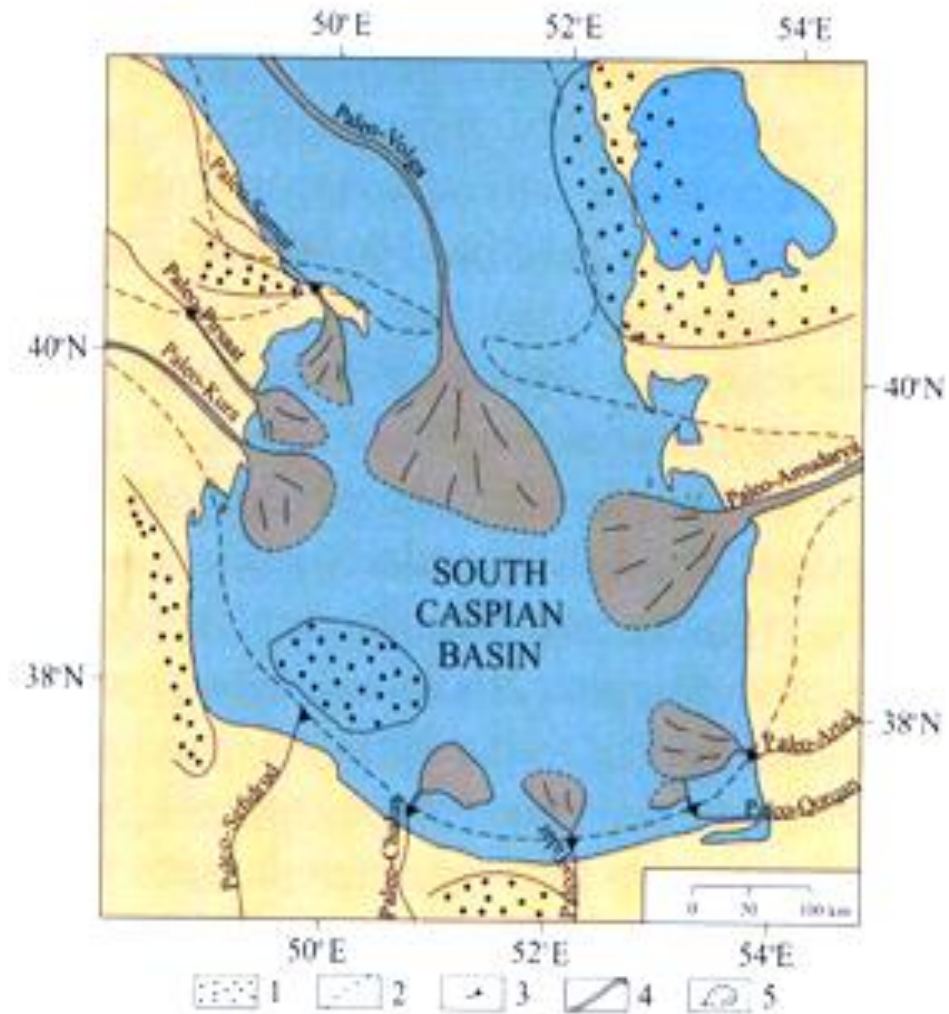
### **2.3. Laterally developed sedimentation - turbidities in riverbeds, delta and avandelta images in seismic sections**

The role of fluvial-deltaic sequences was significant in evolution of sedimentary sequences on the northern continental border of marginal sea – in the southern flank of Scythian-Turanian platform. During the periods of low sea level the sediments were eroded from continental shelves and slopes by underwater flows and dense mudflows down to the slope foot where they created huge cone outcrops.

Later these cone outcrops were flown into the abyssal through canyons and valleys gradually developing the gentle and relatively thin (condensated) covers of oceanic basement. In the South Caspian the origin of the major hydrocarbon bearing target – Productive Series of Early Pliocene is related mainly to three large rivers (Paleo-Volga, Paleo-Uzboy and Paleo-Kur) and paleodelta of several small rivers (Potapov, 1935; Sultanov and Gorin, 1955; Mamedov, 1991, 2010).

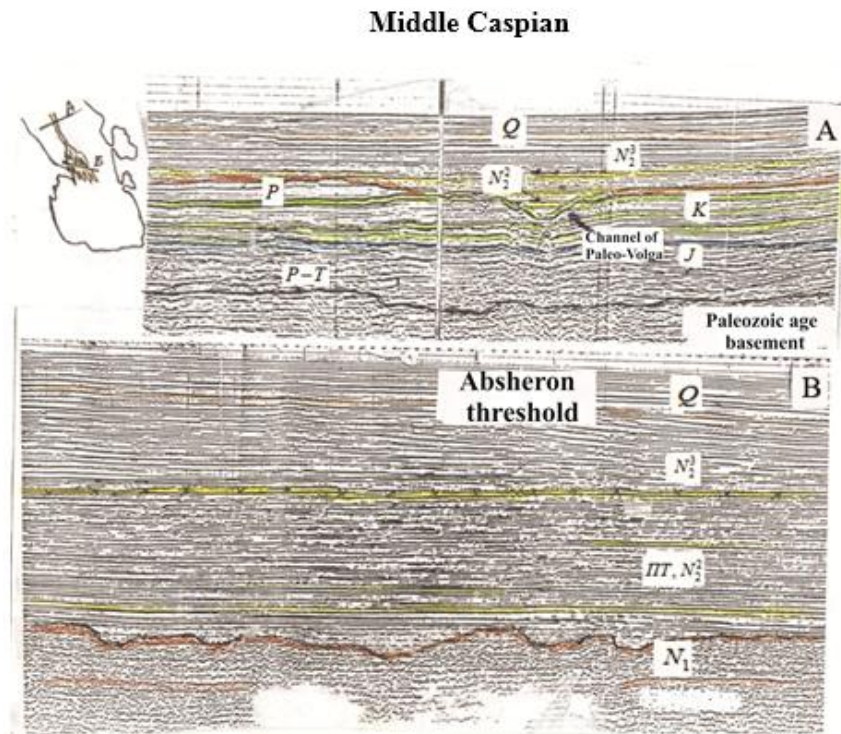
At the end of Pontian during regional “Messinian Salinity Crisis” (5.1 mln. years ago) the sharp decrease (700 m) of erosion basis led to transportation of a huge amount of fluvial-deltaic, sandy-clay (detrital) sediments into the small lake on the south of the Caspian through Paleo-Volga and other rivers **Fig. 2.5**, riverbeds, channels, ravines and underwater valleys.

Seismic time sections allow to trace deep (down to ~700 m) riverbeds and paleo-ravines crossing Cretaceous and Paleogene deposits in the Middle Caspian sea **Fig.6**. These ravines elongate to the threshold of Absheron and create wide accumulative terraces, erosions and inclined riverbeds.



**Fig. 2.5. Riverbeds and deltaic systems in the Early Pliocene basin.**  
*1-relative uplifts;2- basin limits; 3- riverbeds;  
4-large riverbeds and underwater ravines; 5-deltas.*

The origin of cross and lens-shaped boundaries traced on seismic sections derived in areas of rock outcrops in Absheron peninsula and Absheron threshold is related to flows in riverbeds. No doubt that these sediments are of alluvial deltaic origin.



**Fig. 2.6. Paleo-Volga riverbed in the Middle Caspian (A), underwater bars, channels and erosion sections in deltaic system of Paleo-Volga in Early Pliocene (B) on Absheron threshold**

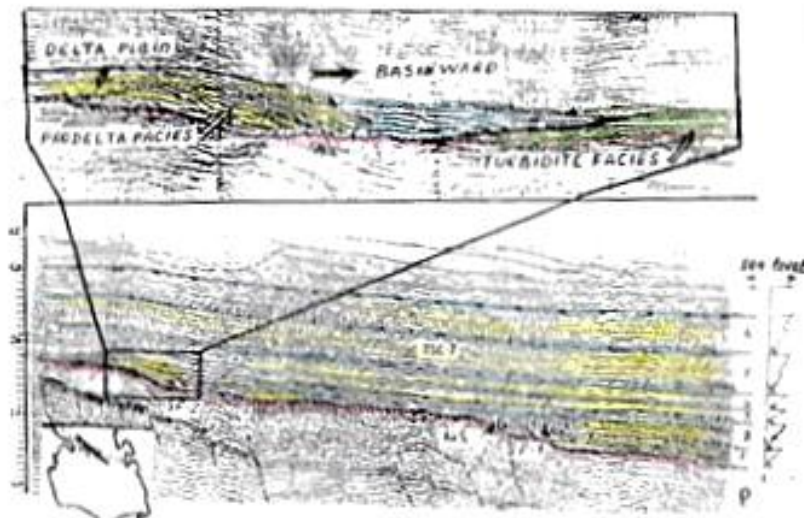
Deltaic and avandeltaic units of Paleo-Volga and Paleo-Uzboy were mentioned in many papers. The huge deltaic system of Paleo-Volga was developing from the end of Miocene to the south for 150 – 200 km (to the center of South Caspian basin) and moved for 200 km to the north (to the center of Middle Caspian) during basin transgression at the end of Early Pliocene **Fig. 7**.

The wide deltaic system of Paleo-Volga developed in the Early Pliocene in transition zone from Middle Caspian to the South Caspian, around the Absheron threshold in particular, has played a crucial role in development of oil and gas bearing Productive Series. Avandeltaic clinofolds of Paleo-Uzboy can be clearly traced in Early Pliocene section in the north-east of South Caspian basin **Fig. 7**.

These clinofolds were developing through the whole paracycle (approximately 500 thousand years) of relative sea level fluctuations in the narrow area (50 – 60 km). Stacked clinofolds consist of initial clinofolds (a), the cover made of conformable

layers (b) and cross bedding (c). According to seismic sections the I – stacked clinofolds cover by 15-20 km laterally and by 100-200 m vertically the initial topographic trough. As a result, new sedimentary slope was developed, which after a long period of hiatus (approximately 300 thousand years) was covered by a new – II clinofold.

This clinofold covered new slope laterally by 30-40 km and vertically by 300 m. Currently this clinofold is buried at 4.5 – 7 km depths. The special attention should be paid to turbidites in deep-water basin of Early Pliocene across the South Caspian basin. In the USA large hydrocarbon accumulations have been discovered namely in such deposit types (turbidites). From the Ventura field only 120 mln.t of oil and 60 mln.m<sup>3</sup> meters of gas were produced from turbidite deposits. In the Mexican gulf also the oil and gas bearing sequence with alternation of high quality reservoirs and pelagic deposits has been attributed to turbidites (Kucheruk, 1989).



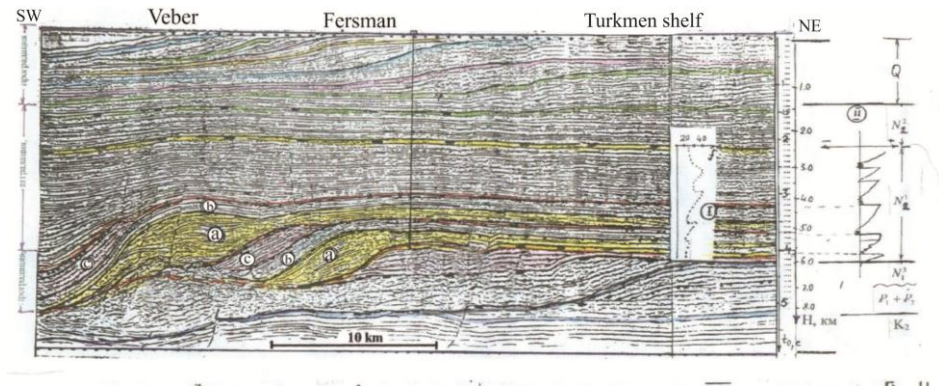
**Fig. 2.7. Delta and avandelta systems of large rivers in the Early Pliocene and delta-avandelta systems and turbidites in pinching out zones of Gala suite.**

They have been accumulated in areas far from frontal parts of deltas and avandeltas and in underwater cones. In the central portion of South Caspian several large structures (Umid, Babek, Inam, etc.) have been discovered by seismic survey. These are mainly located in the areas of turbidites accumulations in underwater cones of frontal parts of large and small rivers deltaic systems (Paleo-Kur, Paleo-Volga, Paleo-Uzboy, etc.) in the Early Pliocene basin Fig.2.8.

Several seismo-stratigraphic indicators for turbidites identification are existed. If canyons or underwater ravines are traced as elongated to far distances it is possible to outline turbidites through identification of sloping and hill-shaped targets. Several



seismo-stratigraphic indicators for turbidites identification are existed. If canyons or underwater ravines are traced as elongated to far distances it is possible to outline turbidites through identification of sloping and hill-shaped targets.



**Fig. 2.8. Chronostratigraphic section displaying relative sea level fluctuations and hiatus in accumulation of Paleo-Uzboy avandeltaic sequence in the South Caspian basin.**

It must be noted that good reservoir properties are observed in lithology of studied fluvial-deltaic systems (in Middle Caspian), paleodelta and avandelta sedimentary sequences (in the South Caspian). The indicated lithology types are the major indicators of commercial hydrocarbon accumulations in Productive Series and Red formation of Early Pliocene in Kur and Western Turkmenistan basins.

### *Summary*

1. In sedimentary cover of Middle and South Caspian basins the laterally accumulated sedimentary sequences are widely distributed on continental margins.
2. Mudflow sedimentation played an important role under the environment of sea level fluctuations in generation of laterally accumulated objects and sequences in various paleogeographic zones of continental margins.
3. Large and tens of small rivers as Paleo-Volga, Paleo-Uzboy and Paleo-Kur played a major role in generation of laterally accumulating objects and sequences during the convergence phase of Middle and South Caspian basin.
4. Laterally accumulating sedimentary sequences of paleorivers, river-delta-avandelta systems played a major role in evolution of oil-gas bearing Productive Series – Red formation in the Early Pliocene basin.
5. To substantiate high hydrocarbon reserves of large anticline structures of Early

Pliocene identified in the middle part of South Caspian basin it is recommended to outline more precisely the area of turbidites distribution by use of seismic stratigraphy technique.

6. It is needed to apply diagnostic tools of seismic stratigraphy analysis more widely in order to identify laterally developed sedimentary sequences and to study their genesis.

### References

1. Abdullayev N.R., Kadirov F.A., Mamedov P.Z., Some aspects of subsidence history and geodynamic evolution of the South Caspian Basin from subsidence modelling. Istanbul International Geophysical Conference and Oil -Gas Exhibition, Istanbul, Turkey, 17-19 September 2012
2. Mamedov P.Z. Models of sedimentation in South Caspian mega-basin and their seismic stratigraphy characteristics. "Stratigraphy and sedimentology of oil and gas basins" journal. 2009. № 1, p. 51 - 67.
3. Mamedov P.Z. Modern structure of South Caspian mega-basin is the result of multi-phase evolution of lithosphere in the central segment of Alpine-Himalayan mobile belt. ANAS, "Izvestiya" journal, Earth sciences. 2010, № 4, p. 46 – 71.
4. Genesis and seismic stratigraphic model of the South Caspian Megabasin architecture South Caspian Basin: geology, geophysics, oil and gas content. Nafta - Press. Baku, 2004. page 150-164.
5. N.Ya.Kunini. Tectonic bases of seismo-stratigraphic analysis and major directions of its applications. "Seismo-stratigraphic studies in USSR". Moscow, "Nauka", 1990. p. 3-29.
6. Shlezinger A.E. Regional seismo-stratigraphy. Publishing house. «Nauchniy Mir». p. 147.
7. Alizade Ak.A., Guliyev I.S., Mamedov P.Z. et al. «Productive Series of Azerbaijan», 2018. M. «Nedra».

## HUMANITARIAN SCIENCES

### AZERBAIJAN KITCHEN

**T. I. Amiraslanov**

*Doctor of Philosophy of Historical Sciences, Professor,  
General Director of the Center National Culinary of Azerbaijan  
e-mail: [kulina-58@mail.ru](mailto:kulina-58@mail.ru)*

Azerbaijani cuisine is one of the most ancient, rich and delicious cuisines of the world. "Azerbaijani cuisine" means not only dishes, the methods of their preparation, but also the main part of the material culture, harmoniously uniting and unifying the culture of the kitchen, its history, philosophy, feast psychology, customs, physiology, hygiene, chemistry, equipment, ethics, aesthetics, poetry and etc. aspects of the kitchen, as well as practical skills created in the territory of the historical residence of the Azerbaijani people lived in full harmony with the environment. For Azerbaijan, national cuisine is not just a meal; it's a way of self-expression and outlook, a subject of pride, a way of self-identification by its people. At the table an Azerbaijani people "tries" (feel the taste) the entire world by means of cuisine. [1]

The Azerbaijani cuisine was created by the genius of the Azerbaijani people in the vast territory which included the Republic of Azerbaijan; Iranian Azerbaijan; Zangezur, Goycha regions and Irevan Khanate- lands which were forcibly cleared of Azerbaijanis in modern Armenia; in Borchaly where Azerbaijanis lived and live mainly, the territory of Dagestan, including Derbent [2]. Naturally, climate is the most important factor affecting the creation and development of the cuisine. [3, 4, 5] In this regard, it is enough to note that 9 climatic zones pass through the territory of the Republic of Azerbaijan, which in turn determines the diversity and richness of the flora and fauna of this region, create favorable conditions for the life and development of all animals and plants, which is also the main basis for the creation of rich cuisine. [1, 2] To create a rich kitchen, in addition to the usage of wild animals, birds, fish and plants, in the subsequent periods of the development of society, the availability of production of agricultural products is also required. For this, the population must have a high culture of farming and animal husbandry. For example, complex dishes of dough and cereal can only appear in cases that production of agricultural products can excess demand for bread baking and substitute of bread. The surplus of cereal appeared for a long time (for years) promoted to possibility to experiment and create complex dishes. When this

lasted for centuries, then the dishes were created and fixed in the people's memory. Only the presence of the "chatan" (archaic prototype of the colander), weaved from reeds, is related to the history of cooking dishes from grain and dough to 5-6 millennium BC and allows us to speak of a stable crop and accordingly of a high level of farming. [1]

The production of large quantities of grain indicates a high culture of agriculture, the availability of irrigation systems, the development of animal husbandry etc. All this is impossible without a settled way of life. It should be noted that in the Transcaucasia the raw materials necessary for the cuisine were mainly produced by Azerbaijanis, who possess a high culture of farming and animal husbandry. For instance, the Georgian scientist M.I. Tkeshelov wrote about the Azerbaijani population living in the Irevan Khanate in 1888: "The villages are engaged in grain growing, agriculture and gardening. Naturally, in lowland areas, in "yaylags" (like summer camping) they are engaged in not only livestock, as Azerbaijanis mainly live on the banks of rivers and they can be called agricultural people. It is possible to say that Azerbaijanis live almost constantly on the banks of rivers, whereas Armenians live only in mountainous areas". [6]

In 1889, L.K. Artamonov noted that: "The largest part of the grain is given by the provinces of Azerbaijan, Khorasan, Kermanshah, Fars, Isfahan and Ezd". [7]

In 1852, G.V. Sollogub wrote that: "The Armenians direct mainly their activity to trade and the accumulation of wealth. Azerbaijanis, accordingly, related with their places of residence, directed their activities to agriculture and cattle breeding and are the main productive elements in Transcaucasia". [8]

I.L. Segalov noted in 1902 that: "The Muslim people mainly live on the banks of the Bazarchay, Ayrichay, Bergushad, Okhchuchay, Choundurchay rivers, their tributary, as well as on the banks of the "Araz" (river), while the Armenian population lives scattered on the harsh peaks of the mountains. A very large part of the Armenian men (from 15 to 40 ages) go to work to the bank of the Caspian Sea, Baku and Tiflis every winter. Here they are attracted by lackey service, street life. As for the Azerbaijanis, they live in the plains and in better conditions of farming". [9]

Of course, this is a natural process. While other peoples came, all the fertile lands were already inhabited and used by the local population. This is also confirmed by the Armenian scientist G.A. Ezov (1908): "New Homeland did not greet very warmly the Armenians, there were very few free state lands." [10]

Notes of various travelers, scientists, merchants, diplomats and others, as well as archaeological excavations prove that in ancient times wheat, oats, rice, sesame, soybeans, beets, melons, watermelon, grapes, apples, pomegranates, quince and other such products of agriculture, melons and gardening products were grown in huge quantities.

Along with these crops of plant-growing, as well as fresh and dried fish, caviar, honey, butter and other livestock products not only have provided local people, but also have been exported to neighboring, nearby and distant countries. [11]

Incontrovertibly, for centuries, all Caucasian markets have been given livestock and plant products produced by Azerbaijanis. For example, Y.D. Angabadze and N.G. Volkova referring to sources in the book “Old Tiflis” write: “At Tiflis markets cheese was sold mainly by ossetians, Azerbaijanis. Cheese was also sold by Borchali people (Azerbaijanis – T.A.). There was a huge demand for trout from Goycha lake brought from Azerbaijan to Tiflis markets (modern Sevan lake - T.A.)”. Thus main people of Transcaucasia, who had possibility to create and develop rich cuisine, having raw materials basis for kitchen were Azerbaijanis. That’s why in Armenian, Georgian, Persian and other cuisines majority of dishes have Azerbaijani roots.

A lot of things have been written about impact of common Turkish cuisine on Bulgarian, Yugoslav, Russian and other cuisines. It’s interesting that Azerbaijani cuisine had great impact on Arabic and Persian cuisines. For example, scientist Javad Khoyat in the book “Comparison of two languages” bring about 60 culinary terms passed from Azerbaijani language to Persian among other words. [12] From linguistic point of view there are certain objective laws of giving names to dishes in Azerbaijani language. The first pattern of culinary terms is related to the fact that, names of dishes correspond to various steps, forms and methods of influence to their preparation. For example, this kind of names such as “gatlama”, “dolma”, “doghramaj”, “azma” show primary technical methods of preparing (gatlama – means “layering”, dolma – “filling”, doghramaj – “crumbling”, ezme – “crush”), “gizartma”(the gizartmaq means fry and name of dish which preparing by frying), “portleme”, “govurma”, “bozartma”, “dondurma”, “khashlama” and etc. – ways of heating influence, “dindilikufta”, “nazikarpagkhangal”, “yukha”, “lula-kebab” and etc. – geometrical forms of dishes, “yarpagdolmasi”, “yarmakhashil”, “duyuchankuru”, “sabzi kuku”, “balkaymak” – main stocks to prepare dishes, “sajichi”, “tava kebab”, “kulfachorak” and etc. – names of furnaces. “Ganja paxhlavasi”, “Tovuz khangali”, “Karabakh basdirmasi”, “Shakihalvasi”, the name of these dishes associated with the regions where mainly these dishes are prepared (Ganja, Tovuz, Karabakh). It is important to note, that when we say dolma, we don’t mean only one dish. There are approximately 380 types of dolma, 200 types of pilaf are known. The second important pattern is “ash”. A series of words come from this word, such as “Ashpaz”, “Ashchi” (chef), “ashkhana” (canteen), “khash” (dish from feet part of the animal – hot jelly), “khashil” (thick floured porridge), “gashig” (spoon) and etc. We come across the words such as “ash”, “as” in many ancient Turkish written sources, including Orkhan – Yenisey and stone written monuments. [13, 1]

Third important pattern are prefixes “ma”, “me”. In names of many dishes there are prefixes “ma” (dolma, gatlama, doghramaj and etc) and “me” (ezme, portleme and

etc). “Ma”, “me” in ancient and modern Turkish languages mean food. Child gets first food from mother’s breast that is called “meme” and name “meme” for breast associated with the food. This may be imitation of the noise of lamb (Gashgari page 340), when it gets hungry it begins to seek mother (food) and bleats “mee-mee”. In Turkish language today child food is “mama, “chojug (child) mamasi (food)”. Thus dolma – stuffed food (dol part means doing stuff, ma part means food), “gizartma” – fried food (gizart part means fry, ma part food), “ezme” – puree, crushed food and etc. The other meaning of prefix “me” from ancient Turkish language is translated as “take” (al). (Mahmud Gashgari “Divanilughatitturk”, Kababchi Yayinevi, 2007 page 340). In this case names of dish called dolma means – fill, form, take, “gizartma” – fry and take and etc. Fourth pattern in forming culinary terms is related to all Turkish languages, for example, in Turkey “Imambayildi” (imam lost his consciousness because of pleasure), in Kazakhstan “beshbarmag” (five fingers), in Azerbaijan “khangal” (khan come), “tarkhan” (young khan – prince), “akhsag-oghlag” (lame goat), “tutmaj” (ajutma – don’t stay hungry), “galaj” (stay hungry), ajab-sandal and etc. After climate the main influencing factor in kitchen is fireplace. [14] For example: majority of baked, cooked and roasted dishes in Slavic, especially Russian cuisine is predetermined with possibilities of Russian furnace. Creation and development of Azerbaijani cuisine is largely related to availability of majority of varieties of open and closed furnaces, such as – “tandir”, “kura”, “bukhari”, “kulfa”, “gala ojad”, “saj”, “dash mangal” and etc. (all this thing are cooking appliances). Each furnace creates its direction in kitchen. For example, kebabs prepared in tandir (like, if you are preparing something in oven, but the temperature is over 350 degree) and mangal (like you prepare barbecue, and direct contact with fire) differ from each other. Baking products prepared in open fireplace under ashes, in “tandir” or “kulfa” in “saj” differ from each other with its taste, consistency, aroma, they taste differently in mouth. Unique dishes and kitchen utensils also had impact on our cuisine. Up to now, our mistresses use various dishes and facilities from the skin of animals, from stone, tree, clay, glass, metal, ceramics and etc. [1] Heat transmission of walls of containers is very important in culinary culture and strongly affects the taste of final product. For example, Azerbaijani chef, physician and enlightener of XV century Mahmud Shirvani in his culinary book writes that: “It’s necessary to cook dishes in stone casseroles, if such a casserole is not available, thus it’s possible to use copper casseroles. Such stone casseroles have been preparing since 2005 in Baku and in ethno restaurant called “Khanadan” they are used for preparation of dishes. In spite of the same recipe and technology of preparation due to variety of heat transmission of dishes clink in stone, copper, ceramic and ordinary casseroles. In these restaurants soups prepared in special samovars differ with their higher organoleptic indicators.

In Azerbaijan up to now the dishes called “dasharasi” (among stones) and “dariustu” (on the skin) are prepared. For “dasharasi” one plain stone (often slate) is heated on fireplace, tail fat is smoothed; meat (chicken or fish) is decomposed on this stone, but above you have to put one more plain stone. And after 15-20 minutes the dish is ready. For “dariustu” skin of the animal is spread out on fireplace with wool below. The ends are fixed to trees or strong post. In this skin pan meat is prepared. For “choban basdirmasi” meat is prepared wrapped in skin. Al Garpati in XII century writes about the dish called “choban basdirmasi” and its preparation method in Baku in animal skin. The whole fish is wrapped in fig leaves and prepared in tandir. Stuffed fish and chicken is smoothed with clay (the chicken is not cleaned from feathers) and cooked in tandir. [16]

Feathers and a part of bird skin is burnt and cleaned together with burnt clay.

In Azerbaijani national cuisine up to now wood, charcoal, dung is used together with gas and electricity as fuel as it was before. Usage of dung is of special interest. In places where dung is used cutting trees and bushes for fuel is reducing. Very interesting fact is in places where dung is prepared and used lungs and respiratory tract diseases are absent. According to researches of Indian scientists’ smoke from dung has antiseptic properties. One of the indicators of the level of culinary culture of the nation is attitude to water, its cleaning and ability to use water. From the ancient time Azerbaijani people divided water to “white” and “black” water. Water that contains a lot of salt, ions, and metals is heavy “black” water and on the contrary, water which contains less ions, metals, salt is soft water. When people prepared drinks and dishes only soft “white” water was used. Willows were always grown on the bank of rivers, irrigation ditches and canals. Roots, branches and other parts of willow that had antimicrobial properties recover water. For this purpose, a piece of branch of willow was dropped into water as vessel or silver thing. For immersion of solids suspended in water in special dish dropped apricot stones. Maybe water was the first and best natural cleaner in the history that is being used by Azerbaijanis. This “sudashi” is stone for cleaning water. “Su dashi” is hollow pyramid of black and white sandstone, which is put on special wooden stand upside down and when water go through, it becomes clean. Below is put some dish for clean water. From above water flows, often here silver thing or branches of willow are dropped. Water passing through capillary pore spaces of sandstone, flows drop by drop into dish for clean water and due to this not only it’s cleaned, but also is chilled by natural ways, because of variety pressure in pore spaces of sandstone and when leaving capillary and the surface of stone as if breaks into perspire and vaporizing from the surface it cools stone and food. It’s important to note that the most ancient samovar which is about 3700 years and found in Azerbaijan (in Shaki district) and it’s more ancient than Egyptian one which is about 2000 years. And this is one of the important points in culinary, moving fireplace from outside to inside of the dish (when you cooking in

samovar, heat is inside samovar), changing water-air balance in water, changing volumes of extraction of nutrient materials in water atmosphere and consequently taste of liquid. [17]

Before in these samovars broth, liquid dishes were cooked and up to now in some villages sakhleb (special dish) from orchid in them is cooked. The next important factor that influences cuisine is historical-geographical destination of nation, mutual relations with neighboring nations. Ancient and trade caravan and military ways passing through the territory of Azerbaijan had special impact on cuisine. Although belonging to common Turkish ethnos brought to presence of the same named dishes that have common roots, it's possible to call Azerbaijani cuisine crown of common Turkish cuisine. From the point of view of proximity of tastes Azerbaijani cuisine is close to Anatolian cuisine and the cuisine of Seljuk's. Long relationship with the Arabs gave our kitchen coffee, silk way brought tea from China. Acquaintance with Russian cuisine on one hand brought to the cuisine of Azerbaijan "shi" and "borsch" which are called among people with the same name "borsch", on the other hand it gave opportunity to be acquainted with distort, russified European cuisine. With the development of the oil industry XIX-XX centuries began straight acquaintance with European cuisine (which process we can see today) and affected on restaurant cuisine. One of the factors influencing strongly the national cuisine of Azerbaijanis was religion and faith of people. Zoroastrianism, fire-worshipping, philosophy of Avesta together with reflection in psychology, manners in ways of thought of Azerbaijanis also found their reflection in cuisine. Respect to first assistant of all chefs – "fireplace" comes from there. Today table customs and dishes which were formed under influence of belief in white light, fire. For long years in Azerbaijan Christian religion was dominant. However, Azerbaijanis have been Muslim for more than one thousand years and the impact of Islam to cuisine is indisputable fact. Refusal of using gold dishes, refusal of pork, prohibition of using alcohol and etc. gives information about strong impact of Islamic traditions. Various holidays, ceremonies and fasting also had great impact on cuisine. It is important to note that the kitchen customs, prohibitions, advices which connected with the religion are the objects of special researches. Here we underline this fact that religion especially Islam has serious scientific basis related to food, food products. For instance, in Islam it is not advised to eat fruits and herbs clearing of their skin. In science only recently it was disclosed that main part of water-soluble vitamins and microelements are found in skin of plants and etc. From ancient times in Azerbaijan meat from large-horned and small-horned animals is used. Historians show that horse meat was used in first phases of development of cuisine. Today Azerbaijanis do not use horse meat as food. In villages of Baku up to now "kutab" is made of camel meat. [17]

In our cuisine meat of wild and domestic animals are used largely. And also interesting fact, that the special sort of sheep (sheep to which are not let male approach)



and castrated animals are considered more delicate and tasty. In mountainous and piedmont districts white marble meat of animals of grassland cattle breeding predominate. In such kind of meat fat droplets include structure of cage. Meat and fat tail of sheep of Karabagh sort is highly valued. Fat tail of these sheep weight 5-10 kg and even sometimes under their fat tail wheel is put. In comparison with frozen meat fresh meat is preferred. Except for meat fat tail and sub products are also used largely as food. For long term storage meat is fried as small chunks together with fat tail and is filled in leather bottle and special clay vessels and from upside melted butter is dropped. Except for this, “gakhaj et” –dried meat is prepared.

It's interesting that rock pictures of bezoar goats in Gobustan (placed in Azerbaijan) with twelve thousand years' history show meat cutting as necessary in culinary. Majority of such drawings give opportunity to say that here culinary was taught.

In our cuisine meat and egg of domestic and wild birds are used largely. Hunting of wild birds begins after snow and after reddening of beaks and feet of birds from cold. Meat of domestic animals – goose, duck and turkey, hen is used as food. Bird is placed in special cage where it cannot move, it's fed with grain which contains a huge amount of fat (grain of corn, sunflower and etc.). Such kind of bird has fat and delicate meat. Bird fat is considered higher quality product than animal fat. Meat of birds, animals is prepared as whole, as large and small pieces, as whole dish or together with other products. [17]

In our cuisine from ancient times minced meat is also used. “Dolma”, “kufta” and etc. is prepared from this kind of meat. Some dishes and sweets in our cuisine are prepared during 6-10 hours at night and are served at 5 o'clock in the morning after first pray (Namaz) of muslims. “Khash”, “Halimashi”, “Halva” seeds (from sprouted wheat) include here. Butter which is saved in Ismayilli (region of Azerbaijan) Historical Museum refers to III-I centuries BC, gives opportunity to talk about development of animal husbandry and products for kitchen. Bones of domestic animals, large and small horned cattle, pork and domestic birds found during excavations in Goytapa in Tovuz (region Azerbaijan) give information about high development of cattle breeding. Petrified spike of wheat, seeds of herbs, beans and grape found here give us information about parallel development of animal husbandry and plant growing 6-8 thousand years ago. Caspian Sea, Kur, Araz and other rivers, lake Goy-gol, Jeyranbatan, Goycha and other enriched our cuisine with wonderful fish dishes. Majority of various dishes of fried, roasted, cooked, minced fish decorate our table.

Fish dishes are prepared from whole fish, large and small chunks, as well as minced fish. Black, red and pressed caviar of fish is used largely. At rock paintings in Gobustan (in Azerbaijan) you can see many fish and fishing scenes pictures together with animals.

Chicken eggs are mostly used as bird product. In dietary cuisine quail eggs are also used. “Gayganag” (like omelet), “chalkhama”, “kuku”, “chighirtma” and etc. also decorate our table today. Dairy cuisine of Azerbaijan has also variety and is rich. Milk, “aghizsud”, “bulama”, yoghurt, cheese, cream, “chiya”, “ayran”, “dug”, “shor” and other dairy products and dishes prepared from them such as – “dovga”, “dogramaj”, “ayranashi”, “atilama”, “sudlusiyyig” and other dishes from ancient times enriched our cuisine.

Azerbaijanis have special respect to bread – “yukha”, “fatir”, “lavash”, “sangakh”, “khamrali”, “tandir-churek” and other various forms, thickness and methods of preparation of bread is the main richness of our table. If bread is put on the table, Azerbaijanis begin to eat it as a respect to bread, because they think that nothing better have to be placed on the table than bread. Bread is respected as Koran and we have special ritual “take an oath on bread”.

Dishes and culinary products of dough have an important place in our cuisine. Note that preparation of dishes with meat and dough is characteristic for all Turkish people. Historian Farug Sumar in his book called “Oghuz” shows proofs that seljuks ate “tutmaj” (dish made of noodles and beans) to prove that Seljuks were Turkish. “Khangal” (“sulukhangal”, “yarpagkhangal”), “gurza”, “dushbara”, “gyirs”, “surfullu”, “khashil”, “horra”, “gindig” and other farinaceous dishes which, shortly, are prepared mainly in winter.

As it's getting warmer the number of meat and farinaceous dishes on tables is reducing and vice versa, preparation of dishes of cultured and wild growing herbs is increasing. “Kata”, “suyug”, “dovgha”, “ajab-sandal” and other dishes and various salads are prepared from chickweed, spinach, beet greens, mint, eggplant, tomato and etc. Grain and bean dishes have important places on our table: “siyyig”, “plov”, “govurgha”, “hadik” and etc. However, “plov” is considered the most wonderful dish (essential part of the dish is rice). In Azerbaijan, in the country, which you can call, definitely, one of the motherlands of rice, 200 types of plovs are known. Rice is substitute for bread in some regions of Azerbaijan. For instance, in Lankaran (region of Azerbaijan) bread was not used as food before. In Azerbaijani cuisine sweets, pastry and halva have important place. The production of sugar in Azerbaijan before helped this. Sugar was obtained from sugar cane, which was taken to Russia from Azerbaijan by the Potemkin, because of Ekaterina's decree. Such kind of sugar was called “takhtagand”. Other kind of sugar was sugar from beetroot. **Nizami Ganjavi also reminds about sugar in the XII century.** Azerbaijanis obtained these kinds of sugar in unrefined form, although refinery of sugar in Azerbaijan for the first time occurred in the X century. Except for these kinds of sugar fruit sugar – “nabat” was also prepared. Presence of a huge amount of honey and fruit juices prepared, condensed in honey thickness – “bekmez”, “doshab” also helped variety of sweet table. Such sweets and confectionery

such as “pakhlava”, “shekerbura”, “richal”, “sujuk”, “peshmek”, “guymag”, “gatlama”, “yukhahalvasi” and etc. are pride of our housekeeper and masters. Presence of sweet starters (honey, sugar, bekmez) and fruits helped creation of amazing products in kitchen. These are various jams, compotes, preserves and products in sugar from cornel, quince, cherry, fig, hazelnut, petals of rose and etc. In Azerbaijan canned vegetables “tutma” with the aid of sour starter “turshular” and salt “shorabalar” are also used. Medical and dietary cuisine has a special place in Azerbaijani cuisine. Many dishes, such as “umaj”, “khash”, “horra”, “guymag” and etc. are used from ancient times for various diseases as treatment. Main part of cuisine is ritual and holiday dishes. Dishes from malt (sprouted wheat grains) are made only in Novruz holiday, “govut” is prepared only in Khidir Nabi, “hadik”, “govurgha” are prepared when first teeth of baby come through or when 100 years old people lose their teeth, in female holiday “Small chilla” in winter special watermelon is cut. One of various parts of cuisine is drinks. “Arag” – vodka is prepared from mulberry, cornelia and some other plants which are mainly used as treatment. “Arag” means “white drink” (ag – *white*, ar – *drink*; in the word “kefir” “ir” also means *drink*). On the other hand, “ar” may also mean *cleared, clean* and the word “arinnish” – *cleared*. [18, 19]

Apparatus made of clay for distillation found in Gabala district say that in the 7-8<sup>th</sup> centuries our ancestry got alcohol and ether oil by the way of distillation. These products were used not only in medicine and perfumery but also in kitchen.

In the book called “Kitabi Dede Gorgud” the drink called “sagrag”, the first ancestry of arag (vodka) and sagi is reminded in some times. Non-alcoholic, medical “arag”, extract and etc. are also prepared from various plants by the way of distillation. For example, arag from mint, “gulab” (rose flowers) and drink from mixed herbs – “chalarag”. From ancient times in Azerbaijan “buza” – beer is prepared. Russian word “buzit” also comes from this word. [17]

In Shamakhi Historical Museum petrified wine referring to I-III centuries BC is saved. Grape grains found in Goytapa of Tovuz (region of Azerbaijan), which is more than 8 thousand years, gives opportunity to make reason about antiquity of winemaking and winegrowing. There are a lot of drinks of milk and sour milk products, such as “ayran”, “atlama”, “bulama” and etc. as in other Turkish cuisines. Various sherbets are prepared of fruit juices, various extracts from plants, sugar and etc. Sherbets are mainly given with plov, drunk during holidays and rituals.

Various drinks, such as “ovshala”, “gandab”, “water mushmul”, “salab” not only decorate tables, but also are of medical importance.

Tea has a special place in Azerbaijani cuisine. It’s impossible to imagine our table without tea. Coffee and cacao are consumed less than tea. Boiled hot milk and drinks from milk are given to table in the morning. Mineral waters of Azerbaijan have a special place among drinks (“Istisu”, “Badamli”, “Sirab”). They are given as thirst-quenching

and they have medical importance. Drinks on basis of “bekmez” (doshab) of cooked juice of mulberry, watermelon, sugar cane, beetroot, grape, wild persimmon and etc. in honey thickness are considered thirst-quenching and useful. For quenching thirst and easy digestion of heavy greasy meals are served drinks, such as “iskanjabi” that are prepared from mixture of honey and vinegar are consumed together with “heavy” greasy meals at the table. In some sources they are called as “vinegar-honey”. Sometimes sugar is consumed instead of honey. In our cuisine “khoshab” (compote) and “palud” (kissel) go under category of drinks (not sweet meals). But, naturally, the best drinks are considered cold, as ice, spring waters of Azerbaijan. It’s necessary to distinguish “yakhma” (open sandwich from the word of “spread”) and “durmak” – special sandwiches during production of which turn products to thin bread – yukha or lavash in form of cunicle or opened tendir-churek, khamrali and other types of bread in form of pocket and put the products into this pocket among daily light meals of Azerbaijani lunch cuisine. Correspondingly, durmaks are called “bukma” (wrapped) or “jibli” (pocketed). “Durmaks” are given cold and hot. It’s necessary to note “maza” – salads among appetizers. But, it’s necessary to note that mixed salads has very small place in Azerbaijani cuisine, vegetables and greens are given mainly in whole form and not as a starter meal, (in Azerbaijani language “achar” – key means opening table), and as accompany. In other words, when you eat whatever meal, for example kebab you eat that with greens and vegetables. This is more useful and tasty. The reason for this is that products in Azerbaijan, such as tomato, cucumber, greens and etc. are very tasty. There was no need to grind up, mix, and add something to give them taste. In countries where products had neutral taste it was necessary to use such methods and many spices. The things which I wrote before also refer to meat, our meat is not spiced a lot either. Better meat is called “Chichek kimi et” literally means meat like flower and there is no need to add to it anything except for salt or pepper. The situation with fruits, vegetables and gardening is also the same. For example, Adam Oleariy (17<sup>th</sup> century) is surprised that in Azerbaijan it’s possible to see so sweet melons that there is no need to add sugar on it. At the end of eating “charaz” (fruits, dry fruits, nuts and etc.) and sweet meals are given. Sauces and decorations are one of the defining factors of richness, variety of development of cuisine. Famous Turkish traveler Evliya Chalabi in the XVII century writes about Azerbaijan: “Here are also famous 12 names of sauces and decorations”.

Sauces from sour milk (gatig) and garlic, from vinegar and garlic and brought to thickness of honey or Smetana, natural juices of fruits are more used. Sauces on basis of fruit and berries paste and “lavashana” (dried fruit and berries paste) are used for various meals. Fish is often given together with narsharab (sauce of pomegranate juice) or sauce on basis of narsharab. Sea salt and “dakhar” are also given to the table together with dishes except for pepper, sumac. Dakhar – this is salt with various additives. For

example, “Dakharnane”- salt with mint, “Dakharkekotu” – salt with thyme and etc. These types of salt give exclusive piquancy to dishes.

In Azerbaijani cuisine menu is organized by taking into consideration season, weather, age, life style of consumers, locality and etc. Food groups such as Aran meals (in lowlands), dietary meals, expectant mother meals, daughter-in- law meals, fiancé meals, child meals, meals for the youth and the old and etc. National cuisine has diversity, about four thousand dishes are known in Azerbaijani cuisine. According to information by English traveler Antoni Jenikson in Shemakhi for one sitting firstly 150 dishes were brought, then took and brought more 140 dishes to Abdulla khan. This variety in cuisine was created by housewives and specialists. This variety was created by dividing labor among specialists. Evliya Chelebi reminds that “here 12 chef workshop associated with names of 12 imams, where thousands of people worked”. There were bakers, “chorakchi (bread baker)”, “yukhasalan”, “shatir”, “ashchi”, “piti makers”, “kebabchi”, “chaychi”, “halvachi”, confectioneries, “sherbetdar” and etc. Specialists called with the names of those groups of dishes and products up to now work in our massive food enterprises. This kind of division of labor and its development helped to increase amount of the same named dishes. For example, about 200 types of plov, more than 380 types of dolma, 20 types of lule-kebab and etc. are known. [20]

Moreover, when we talk about 380 types of dolma, it’s necessary to take into consideration subspecies too. For example, if we talk about “kalamdolmasi” (dolma from cabbage leaves), then it has subspecies: kalamdolmasi from minced mutton, beef, turkey poultry, with vegetable minced meat. “Kalamdolmasi” with minced mutton, in its turn, has regional subspecies, by adding greens, rice, chestnuts, and hazelnuts to minced meat. When preparing this dolma in one region a bit of sugar is added, in other region “bekmez” with vinegar, in the third region only it’s salted and etc. The most long-livers in the world – Azerbaijanis created the healthiest cuisine, since it’s very hard to live long without healthy cuisine. Azerbaijani traditional table culture requires eating with hands. Our thin bread (“yukha”, “sangakh”, “lavash”) is turned as spoon and with its aid liquid dishes are eaten together with improvised “spoon”.

Hard parts are covered with such thin bread. Eating with hands has preferences:

1) At the ends of fingers of hands are located very sensitive nervous endings. Although extrasensory perception adepts don’t work with hands, but the blind as if see with eyes. Hands feel hot compositions, consistency of dishes;

2) When food is taken to mouth with the aid of spoons and forks, it’s possible to burn or strongly cool mouth cavity. During eating with hands food drops into mouth at the temperature of near temperature of body, but at such temperature taste receptors and ferments in mouth cavity better work. Such food is not swallowed fast, but swallowed

well. It is said for reason in Islam to eat and drink food in very hot condition is prohibited, it's recommended to eat dishes in warm condition;

3) During eating food with metal forks or spoons ions of metal destroy fluorine and iodine, this causes to damage teeth;

4) Eating with hands makes to obey to high hygiene rules, it's necessary to wash hands carefully, and this turns the process of eating to small holiday, and prepares human psychologically to longer eating process.

According to customs, after accurately washing hands, fingers are washed with rose water one more time. [22] According to requirement of Islam it's necessary to eat only with right hand. Scientists say that right hand carries positive energy. In Azerbaijani language the word for right hand is "sağ" – health is related to it. In Azerbaijani language the word "gonagparvarlik" (hospitality) differs from such words in other languages in its context. In German "gastshaft" means to be friend with guests, in Russian language hospitality means to having guests. But "gonagparvarlik" is broader concept which includes having guests, to be friend with them, fondle, entertain, take care of them, treat kindly, give presents, exalt guests and many other things. It's necessary to note that position of cuisine may be defined due to its influence to cuisine of surrounding nations. If Chinese cuisine had a great impact on Asian cuisine (Thailand, Malaysia and etc.), French cuisine to European cuisine, then Azerbaijani cuisine became basis for cuisines of neighboring nations. Thus, Azerbaijani cuisine at its own influence is in the same line with that of Chinese and French. Appearing of technological ways and delicate dishes, creation of recipes and culinary directions naturally is related to creation of palace cuisine and open public food enterprises. In the book called "Adventures of Samak Ayyar" referring to the X century we see that Samak Ayyar hides in Tabriz Chaykhana – in canteen where nearby foods and tea are sold. Presence of state defined presence of palaces and palace kitchens. In books of X-XII centuries we read about majority of culinary products and dishes which are also prepared today. Chefs' palace kitchen copybooks and mainly palace chefs' books give opportunity us to say about development of Azerbaijani cuisine in middle ages. Chef book by Mahmud Shirvani - senior chef and senior physician of Sultan Murad (beginning of XV century), culinary book of poet Etim (XV century), recipe book of Baverchi, who was senior chef of the palace of Shah Ismayil Khatai (1521 year), Book of recipes by Usta (master) Nurullah, who was private chef of Shah Abbas (1590 year), culinary book by Mayor of Tabriz Nadir Mirza Gajar (XIX century) written together with his wife who was from Barda (in Azerbaijan) and other people inform about interrelated, unified, developed culinary culture of Azerbaijanis. Many ancient and middle ages technology, ways of preparation, names of dishes, recipes are used today in national cuisine of Azerbaijanis in unmodified or little modified form. [23] Today 380 recipes of only dolma have been collected, written and recorded. 10 of them have already obtained patent (dolma of Absheron with

olives, dolma of Baku in grape leaves, gupa dolma of Nakhchivan, gira dolma of Kangarli, dolma of Lanakaran region in lemon, dry dolma of Gakh region, fish dolma of Salyan region, apple dolma of Guba region, hazelnut dolma of Gabala region, pip dolma of Ismayilli region). In 2016 lavash was included into the list of immaterial heritage of UNESCO as a bread of Turkish nations, but dolma was included into the list of immaterial heritage of UNESCO as a dish of Azerbaijanis in 2017. [24] In Azerbaijan state postal marks with pictures of 26 Azerbaijani dishes were released. Marks released in 2016 with pictures of dolma in grape leaves and “piti” were signed by the President of World Association of Culinary Societies Thomas Gugler became rarity. Also 4 marks, released in 2018 (shah plov, Arzumankufta, khash and Alana) were signed by the President of the Republic of Azerbaijan Mr. Ilham Aliyev and First Vice-President of the Republic of Azerbaijan Mrs. Mehriban Aliyeva. National dishes and products were included into the list of immaterial heritage of Azerbaijan. Article 37 of “The law of Azerbaijan about culture” took under defense of the State this unique cuisine. [25] The most ancient picture in the world, demonstrating meat cutting of animal for culinary purpose on rock pictures of Gobustan; the most ancient samovar of the world was found in Shaki; the most ancient distillation device in Gabala; the most ancient butter in Ismayilli up to now in the kitchen of the most ancient ways of preparation of dishes and materials of archeological excavations show outlook, source of pride of Azerbaijani people in the ancient culinary heaven saved in the world, cradle of culinary culture of the world. However, in Azerbaijani cuisine the most important is not tasty dishes and fragrant drinks, beautiful fruits, the most important in our cuisine is guest. On basis of philosophy of Azerbaijani cuisine, the main part is guest.

So, welcome, be our guests.

### References

1. “Azərbaycan Kulinariyası Ensiklopediyası”. Под научной редакцией Тахира Амирасланова. Баку. Изд. «Шерг-Герб», 2007 год. Стр.14
2. Tahir Əmiraslanov, Sevil Ağamaliyeva “Azərbaycan mətbəxi”. “Azərbaycan Milli Ensiklopediyası” под редакцией Ильхама Гейдаровича Алиева. Баку, изд. «Azərbaycan Milli Ensiklopediyası Elmi Mərkəzi» 2007 год. Стр. 128-130.
3. Bextiyar Tuncay “Distribution of the Turkic haplogroup R1a in Europe” <https://bextiyartuncay.wordpress.com/2018/06/21/>
4. Бахтияр Тунджай «Генетическая история Тюрков по результатам палеогенетических исследований» <https://bextiyartuncay.wordpress.com/2018/05/31/>
5. Бахтияр Тунджай «Кура-аракская культура и огуза-кипчакская гаплогруппа R1b» <https://bextiyartuncay.wordpress.com/2018/05/26/>
6. М.И. Ткешелова «Азербайджанские татары» в «Сборнике материалов по этнографии, издаваемый при Дашковском этнографическом музее», Выпуск 3, М., 1888, стр. 99-114.

7. Л.К. Артамонов. «Персия как наш противник в Закавказье», Тифлис, 1889, 193 стр.
8. Г.В. Сологуб. «Записки Кавказского отдела Императорского Русского географического общества», книга 1, Тифлис, 1852, 296 стр.
9. И.Л. Сегал. «Елизаветпольская губерния, впечатления и воспоминания», Тифлис, 1902, 104 стр.
10. Г.А. Эзовь. «Сношения Петра Великого с армянским народом», С. –Петербург, 1898, 512 стр.
11. Н.Д. Ангабадзе и Н. Г. Волкова. «Старый Тбилиси», М., «Наука», 1990, 270 стр.
12. Cavad Heyət. “İki dilin müqayisəsi”, Bakı, “Elm”, 100 səh.
13. Тахир Амирасланов и др. «Azərbaycan mətbəxində dolmalar 380 resept» Баку, изд. «Шерг-Герб», 2018 год. 348 стр.
14. Mahmud El-Kaşgari “Dîvani Lügət-it-türk” İstanbul, изд. “Kabalcı” 2007 год, 725 стр.
15. Muhammed bin Mahmud Şirvani “15. Yüzyıl Osmanlı Mutfağı”. İstanbul, Gökkuşbe, 2005 год, 355 стр.
16. «Путешествие Абу Хамида Ал-Гарнати в Восточную Европу (1131-1153 г.)». М. Наука, 1971 год, 135 стр.
17. Tahir Amiraslanov, Aynura Amiraslanova “Azerbaijan Culinary”. Baku, printed “Qanun”, 155 стр.
18. Материалы совместной международной археологической экспедиции “Fərhad Quliyev və Yoshihiro Nişiyaki rəhbərliyi ilə, Göytəpə və Hacıəlləmханли Neolit dövrü yaşayış yerlərində arxeoloji tədqiqatlar”. Стр. 308-334 в сборнике «Azərbaycanda arxeoloji tədqiqatlar», Баку, Институт Археологии и Этнографии NANA 2012 год.
19. F.E. Quliyev, Y. Nişiyaki və başqaları “Göytəpə qədim yaşayış yerində arxeoloji tədqiqatlar” в сборнике «Azərbaycanda arxeoloji tədqiqatlar» стр. 50-64, Баку, Институт Археологии и этнографии NANA, 2011 год.
20. Nizami Gəncəvi “Yeddi gözəl”, Bakı, Yazıcı, 1982 год, 688 стр.
21. Tahir Əmiraslanov “Şəkər (qənd) haqqında dastan”, стр. 134-137 в книге Т. Амирасланова «Mətbəx dastanı», Баку, Шерг-Герб, 2005 год.
22. “Kitabi-Dədə Qorqud”, Bakı, Yazıcı, 1988 год, 265 стр.
23. Адам Олеарий. «Подробные описания путешествия голштинского посольства в Московскую Персию в 1633, 1636, 1639, гг. » М., 1870, 1038 стр.
24. Эвлия Челеби. «Книга путешествий, М., Наука, 1983, 376 стр.»
25. «Путешественники об Азербайджане», Баку, 1961, 37 стр.
26. «Самак Айяр» М., Из-во «Наука» 1984 год, 560 стр.
27. Nadir Mirzə Qasar “Karnamə” с предисловием Тахира Амирасланова. Баку. «Elm və təhsil». 2013 год, 209 стр.
28. Ирод Афшар “Aşpəri digeyi səfəvi” на персидском, Tehran/crud 1389, Хиджри 2010, 216 стр.



## **AZERBAIJAN-TURKEY FRIENDSHIP AND BROTHERHOOD IS AN EXAMPLE FOR WORLDWIDE**

**Afat Mammadov**

*The deputy editor in chief of “Khalg qazeti”,  
Honored cultural worker of Azerbaijan Republic,  
Active member of the International Academy of Sciences*

Azerbaijan and Turkey is situated in the junction of Europe and Asia continents for their geographical territory. The history of the relations of these countries which have common origin, languages, religion, traditions and culture are very ancient. Turks and Azerbaijani turks as one of the ancient nations of the world has passed long historical way.

This territory is considered one of the first settlements of civilization. According to scientific sources, the scientists decided that history begins from Turkic Sumerians after worldwide flood—Nuh’s storm. The historical investigations show that the first turks were Sumerians B.C. 4000. The Turkish speaking nations who have several thousand year statehood history created “Kitabi Dada Gorgud”, “Bilgamish” “Koroglu”, “Asli and Karam”, “Tahir and Zohra”, “Ashig Garib” and other ancient heroic and love dastans. Azerbaijan gave Zoroaster (the homeland is Azerbaijan) and first written holy book “Avesta” (“Law”) to worldwide.

“Gobustan”, “Gamigaya” and other monuments (Azerbaijan) which have the ancient Turkic writings, The Central Asia, Russia, the Western Mongolia, Scandinavia, Norway and other countries’s root and traditions are related with Turkic nations. Turkey and Azerbaijan had rich statehood history and culture.

Since the beginning XIII century, Turkey has developed and became empire during 7 centuries. In the works written by medieval scientists Saljug and Azerbaijan Atabegs were commented as muslim dynasty. That’s why history of relations between Azerbaijan-Turkey goes to more previous period. The investigated cultural monuments in area of Azerbaijan, our ancient ancestors’ settlements, founded out various labour and house holding monuments during archeological excavations belongs to VI-I centuries B.C.

The materials that belonged to Eneolithic, Bronze and Iron period show that Azerbaijan is one of the ancient countries of the world. There are a lot of caves where lived ancient persons, stone instruments, Cyclops, castles, stone graves, defense constructions, rock paintings in Azerbaijan.

Turkey is called “the country of Sun and history”. The appearing of the Turkey state belongs to early Middle Ages. Ancient Turkic tribes came to Anatolia from Altai mountains though the Northern way in III-IV centuries. In central Asia Turkic tribe

unions –Turkic khaganate (Tugyu) were strong empire in 552-745 years. The area from China territory to Byzantine, including the northern Crimea and Caucasus belonged to Turkic khaganate. The great Turkic scientist Mahmud Kashgari (XI century) wrote that “turk” is the name of the prophet Nuh’s son and the name put by God. The name of “turk” means “strong”, “brave” which is the name of ancient nation. In 70 years of XI century turks were settled massively in Anatolia. In the northern-east part of Anatolia Saljugs (oguz and Turkmen) tribes created their first state. Saljugs belonged to qniq branch of oguz tribes, they lived in Zarafshan valley between Bukhara and Samargand.

The turks achieved success not only in political sphere but also in economical sphere too. Turks had ancient Silk and caravan road which united East and West.

The Asian part of Turkey is called Anadolu (meaning is East). Anatolia turks are very close to Azerbaijan turks with their traditions and ancient roots. Azerbaijan turks belong to the south-western oghuz group of the Turkish family of languages. The word of “Oguz” is “smart”, “experienced” in Turkish language.

Oguz is the independent language created in basis of tribes unions. Azerbaijan, Turkmen, turk and gagauz languages were formed in the basis of oguz language. It means that Oguz language group are closer to Turkey turks’ language than other Turkic languages. Especially ancient Azerbaijani language is close to modern Turkish language.

Azerbaijan language is easy understood in Turkey and it is almost same language (red: Afat Sadıgoglu Mammadov) There are more 50 million people speaking in Azerbaijani language which is more than 1300 years. Approximately 3 million Azerbaijani people live in Turkey Republic.

Turkish philosopher, poet and writer Ziya Goyalp (1876-1924) wrote in his poem about turks who belong to ancient nation.

*Don't ask me my homeland and my belonging.*

*I live as nation for more 5 thousand years.*

*Don't ask my family and my ancestor*

*My origin is turk, my ancestor is conqueror*

In periods of Saljug state (XI-XII centuries), Osmanli empire (XIII-XIX centuries), Turkey Republic--Mustafa Kamal Pasha Atatürk (XX century). There were some tensions in historical friendship and brotherhood relations between Anatolia and Azerbaijan turks depending on political issues, though these nations lived in the various states and different political systems, they never forgot their national Turkic identity, in all possible historical periods they continued their close relations, tried to create mutual relations and support each others. One of the important pages of our common history happened in the beginning of XX century.

In may 28 1918 the first democratic republic in the Muslim East—Azerbaijan Democratic Republic was founded in Northern Azerbaijan. Azerbaijan always felt and saw Turkey and Turkish nation's support in all difficult periods.

Turkey began national struggle by the head of Mustafa Kamal Pasha and cleaned their Turkish territory from Armenian and other forces in 1918-1919 years. Turkish nation showed its support to Azerbaijan too. Caucasian Islamic Army which was lead by Nuru Pasha by the Enver Pasha's order was sent to Azerbaijan and helped to Azerbaijan people to get red of the bloody tragic events, this army lost her brave soldiers in Azerbaijan.

On September 15, 1918, the Caucasian Islamic Army liberated Baku from Bolshevik and Armenian invasion by the command of Nuru Pasha. The liberation of Baku has become an important historical event in the history of Azerbaijan-Turkey friendship and brotherhood. In 1920, Soviet Russia occupied Azerbaijan and the country was again an integral part of the Russian-Soviet Empire. While being a part of the USSR, the relations of the Azerbaijan SSR with Turkey were banned.

In the Soviet period, in the conditions of totalitarianism, relations between Azerbaijan and Turkey were established on the basis of the treaty, agreement and international documents signed between USSR and Turkey for 70 years. These were just economic, trade and cultural relations. The political leadership of the USSR has been fighting extensively against the Turkic issues.

The main purpose was to deny the fact that the Turks, including Azerbaijani turks, lived in these areas from the ancient times, and propagate the Azerbaijanis' settlement in the area from the Middle Ages. In other words, they wanted to isolate Azerbaijanis from their past and make them to forget about their ethnic origin. Even in Azerbaijan, the publication of Turkish literature was banned. Meanwhile, material and moral damages have been made against the Azerbaijani people in this period.

Some forces used all possibilities. In 1937, dozens of well-known Azerbaijani intellectuals were labeled "panturkist, they were arrested and killed. All these bloody steps has been done to shatter the national spirit of the nation. In the 80s of the last century, trade and economic relations between Turkey and the USSR started to revive. However, during this period the Armenians deeply rooted in all the Union organizations, including foreign policy and foreign trade, committed obstacles against creating the Soviet-Turkish relations in different ways.

They claimed "panislamism", "panturkism", "turanism" existed in Azerbaijan-Turkey relations. between the Arabian Turks and Turks have be that is why the armenians approached the turks from the hostile position and described them as "bloodthirsty" and "wild", published various books and distributed to world community. The treacherous Armenians have used the help of their patrons to spread around the world that the Turks committed "genocide" against them.

According to this policy, there were no consulates of Turkey in Azerbaijan in the Soviet era, though the consulate of neighboring Iran and Iraq were active in Baku.

The Turkey Republic and the Turkish people always lived in the heart of the Azerbaijanis during Soviet period. The repressions and pressures that have been carried out in the USSR for decades have not undermined the national independence of our people, and Azerbaijani people, who did not agree with the empire's antimongol, chauvinist policy, struggled for their national rights.

The collapse of the gigantic empire, such as the USSR, the national struggle beginning from 70 years of XX century leading to the restoration of the state independence of Azerbaijan, is directly related to the phenomenal personality, the national leader Heydar Aliyev's services.

At the end of the XX century, Azerbaijan's national leader ensured the idea of national statehood as a sparkling reality in the sovereignty of the Azerbaijanis, as an independent state of Azerbaijan, and provided the inviolability, democratic rise, eternity, persistence, irreversibility of the state created by the great sacrifices.

In the second half of the 80s of the XX century and early 90s, several USSR republics began to attempt to establish independent relationships not depend on Moscow. In this regard, the Republic of Azerbaijan adopted a constitutional act on Sovereignty in September 1989 and began to establish relations with the countries of the world, especially firstly with Turkey Republic.

After many years, as a result of national struggle on October 18, 1991, the northern part of Azerbaijan restored its independence. The Republic of Azerbaijan became an independent state. Azerbaijan has been living and developing for over 27 years as an independent state. The Republic of Turkey was the first country to recognize Azerbaijan's independence on 9 November 1991.

As it is seen from historical relations between Azerbaijan and Turkey, the relations between the two countries have been continued for centuries. The geostrategic position of Azerbaijan and Turkey, the location of these countries at the crossroads of Eurasia, world culture, world politics, and Eurasia's international trade routes caused the world's attention throughout the history.

Political, diplomatic, economic, scientific, technical, cultural, social and humanitarian ties between Azerbaijan and Turkey have been closely linked to each other from time to time, and these friendly and fraternal states have risen to a strategic partner in the XXI century. After gaining independence, mutual relations with Turkey Republic have begun again. These relations can be considered as restoration of diplomatic relations between Azerbaijan and Turkey after 70 years.

Thus, in 1992, embassies in Baku and Ankara opened. In recent years, bilateral relations between Azerbaijan and Turkey and international cooperation have been developed and a number of visits have been carried out.

During these visits, numerous agreements on the development of bilateral relations have been signed. Turkey has supported and strived for the strengthening and gaining high image of the brother country Azerbaijan in international level. It is no coincidence that the national leader of the Azerbaijani people, Heydar Aliyev expressed this solidarity as "one nation, two states "

Over the past time, Azerbaijan and Turkey have taken joint steps in all spheres, including political, military, economic, cultural, and social issues, implemented significant projects on the regional scales. The law of moving together in the foreign policy of Azerbaijan and Turkey has always been a directive.

Turkey has closed the border with Armenia as a reaction to the occupation of 20% of its territory by neighboring Armenia. Azerbaijan has raised this actual topic and expressed its position in the international arena and in bilateral meetings. The "double standard" position of the world community in this issue is damage to international peace and security as well as a peaceful settlement of the Armenian-Azerbaijani Nagorno-Karabakh conflict. It encourages Armenia to pursue a continuous aggressive policy. International law requires the punishment of the aggressor state.

Because no state can interfere with the territorial integrity and political independence of another state. Settlement of the Nagorno-Karabakh problem with the frame of the territorial integrity of Azerbaijan and the return of the occupied territories of Azerbaijan is of great importance in ensuring peace and stability in the Caucasus. Azerbaijan and Turkey have operative mutual consultation and communication in all areas. Signing of the Agreement on Strategic Partnership and Mutual Assistance during the visit of the Turkey Republic President Abdullah Gul to Azerbaijan on August 16, 2010 is a natural result of the traditional partnership, solidarity, persistence and firmness. At the Istanbul Summit of the Heads of Turkic Speaking States in 2010, a common idea was created to establish the Turkey-Azerbaijan High Strategic Cooperation Council in order to further strengthen the strategic partnership. The first meeting of the Council was held in Izmir on October 25, 2011 with participation of President of Azerbaijan Ilham Aliyev and Prime Minister of Turkey Recep Tayyip Erdogan.

Nearly 20 documents were signed at the meeting, where 10 ministers from two countries attended the meeting. Bilateral relations were discussed widely. The bilateral economic relations between Azerbaijan and Turkey have risen to a level of quality and dynamics that can be a model and model for neighboring countries during the period of independence.

The economic relations are developing rapidly every year. Baku-Tbilisi-Ceyhan, Baku-Tbilisi-Erzurum oil and gas pipelines, Baku-Tbilisi-Kars railway, TANAP (Trans-Anatolian Gas Pipeline (Trans-Anatolian Pipeline), which is completed in 2018, will be constructed as a result of efficient and active cooperation in the field of bilateral relations. The Natural Gas Pipeline project has increased the regional position and transit

importance of Azerbaijan and Turkey and has contributed to the development of existing cooperation in various fields.

The development of political and economic relations between the two countries has turned them into key actors of regional politics. Mutual trust, friendship and brotherhood between Azerbaijan and Turkey are the key factors that allow for the implementation of such global projects.

They are important elements of Europe's energy security. Friendship and brotherhood, cooperation between Azerbaijan and Turkey show itself in every field. Mutual investments, trade, education, science, media, agriculture, tourism, culture, technical cooperation, exchange of experience between non-governmental organizations and human relations are closer.

Within the framework of existing cooperation and solidarity between Turkey and Azerbaijan on international and regional platforms Turkey supports Azerbaijan, Azerbaijan supports Turkey in almost all issues. Turkey has actively supported Azerbaijan's election as a non-permanent member of the UN Security Council for 2012-2013 and has been very pleased and proud of the fact that Azerbaijan has been elected to such an important position for international security and peace which has been recognized by the world community as a non-permanent member by taking 155 votes to the UN Security Council. Turkey's assumption of this post for 2012-2013 after Turkey's non-permanent membership in the UN Security Council between 2009 and 2010 is an indication of the authority of both countries in the international arena.

Azerbaijan attaches great importance to the development of relations with Turkey in the field of diplomacy. After gaining the state independence of Azerbaijan, its relations with Turkey were rapidly developing on a historical foundation and soon reached a peak of alliances that did not have analogies in the short time.

The strategic allied relations between the two friendly and fraternal countries have risen to the highest levels in the past and have been eternal and irreversible. As a result, in the past few years, both allied countries have been active in various international organizations, including the United Nations, the European Union, the OSCE and the Council of Europe give each other the necessary support.

Turkey insists on justifying Azerbaijan's position on all international meetings and demanding immediate and unconditional liberation of the occupied Azerbaijani lands from Armenia. On September 15, 2018, a magnificent military parade was held on the occasion of the 100 th anniversary of the liberation of Baku by Turkish Army. Congratulating all citizens of Azerbaijan and Turkey on the occasion of this historic event, President of Azerbaijan Ilham Aliyev said: "Today, the Azerbaijani-Turkish relations are at the highest peak. I think there is no second example in the world that the two countries are close to each other, Let each other be a backbone.

Our unity gives us a breakthrough in all spheres ... Today the whole world sees that Turkey and Azerbaijan are together, and the whole world sees that our unbreakable friendship, our brotherhood is eternal."

President of the Republic of Turkey Recep Tayyip Erdogan, who participated in that parade, said in his speech: "Azerbaijan is the most martyr's country after Turkey. The martyrs who sleep along with the graves here are also representatives of the common fate among our countries. Turkey and Azerbaijan are two brotherly countries with a history, culture and language. The great poet, Bakhtiyar Vahabzadeh, expressed this unity very well:

*The two sons of the mother  
The two branches of one aim  
Azerbaijan-Turkey  
Both of them are ancient  
Azerbaijan-Turkey...*

Yes, the unity of Turkey and Azerbaijan is the best example of brotherhood that embodies these symbols. "

Strategic Allies-Azerbaijan and Turkey are effective and active in the implementation of various regional projects the peoples of the two countries, are proud of and benefit from this cooperation.

Historical, cultural, humanitarian bonds are interconnected. The peoples are progressing in the same way of thinking and they go towards new discoveries. The history, development and unshakable unity of Azerbaijan-Turkey relations, which can not be compared with other countries, have become the symbol of a brotherhood that is an example for the whole world.

## **CASPIAN OYCUMEN IN THE WRITTEN AND MYTHOLOGICAL TRADITION OF ANCIENT WORLD**

**T. Sh. Khalilova**

*International Academy of Science, Azerbaijan Section,  
Baku, Azerbaijan*

### **Introduction**

The study of the history of the peoples of the Caspian region involves a systematic approach. It provides: analysis of ancient written sources; attraction of archaeological data; the study of toponymy of the region; geological history of successively alternating bodies of water up to the present-day Caspian, i.e. the totality of elements characterizing the evolution of the peoples of the Caspian region. This is due to the fact that an attempt to explore the geographical descriptions of antiquity based on the current geological and geographical situation, leads to a distortion of real history. Paying tribute to the mythological tradition of the Indo-Persian peoples, written sources of ancient authors and the rich material of the Chinese documentary base, in the light of the achievements of modernity, you can find a new look at the history of the peoples of the Caspian region.

### **1. Greek and Roman authors about the Caspian Sea.**

Greek and Roman sources contained information about the Caspian Sea, leading to opposite conclusions, fixed in cartography, from discussing its name to determining the form, size and nature of isolation. A number of authors think that in antiquity it was the closed and was a lake. Others think that it had a connection with the oceans.

Ancient authors about the closed nature of the Caspian Sea

- Herodotus claimed on the closure of the Caspian, [9.1.202].

- The phrase of Aristotle, "... at the foot of the Caucasus there is a lake, which the locals call the sea. Although many large rivers flow into it, it has no visible flow ..."[5.b.1.p.13.§ 29] testifies to the isolation of the Caspian Sea, he also speaks about this in the next paragraph "are inhabited around"(II , 1, 10) [12. p.175].

- Apollonius of Rhodes noted very poetically about the character of the Caspian Sea: "In the Caspian Shell" [12. p.281]. This expression is also astonishing because of the fact that only data from modern studies of the depths of the South Caspian depression confirmed that in reality the structure of the bottom of the basins of the South and Middle Caspian are very similar in shape to sea shells.



- Ptolemy [19. VII, 5: 4], and Aristotle in "Meteorology" [5. I, 13: 29; II, 1:10 and approx.] "show the Hyrcan Sea as if the island is surrounded by land" [12. p.949].
- Ptolemy on his map depicted the Caspian Sea as a closed oval, extending from west to east [19. VII, 5.4].

Information about the Caspian Sea as a closed basin continued to exist along with the opposite point of view.

### **Representations of ancient authors about the connection of the Hyrcan (Caspian) Sea with the Ocean**

The ancient mythical and cosmographic representations of the Greeks were based on the connection of the Hyrcan (Caspian) Sea with the ocean. The description of the Caspian Sea as a bay which is open to the north is reflected in the cartographic schemes which are under influence of the reports of the sailing of Patroclus and the maps of Eratosthenes, despite the fact that the map of Ptolemy (2nd century AD) represents the Caspian Sea not as a bay but like the isolated sea. The reports of Patroclus convinced the contemporary researchers (Claude Repin [21. p. 99], Elnitsky [10. p. 130], Pyankov [20. p. 98]. Heinig R. [24. v. 1. ch.26]) and others, that his sailing on the Hyrcan Sea was limited to the Southern Caspian. Therefore, the strait to the ocean is the strait to the Middle and Northern Caspian, to the so-called "Ocean". According to Pliny, the Caspian Sea also flows from the "Ocean" through the strait [16. B.VI.XV.38].

The phrase of Apollonius of Rhodes, who noted: "The Caspian Sea near the Ocean" [12. p.281] makes us make this conclusion. Arrian, speaking of the Hyrcan Sea, in the first extract [4. B.V.26.2] notes that it merges with the Indian (ocean or sea), in the second - it is the Gulf of the Great Sea [4. b.V.5.4].

Strabo also reported on the connection of the Hyrcan (Caspian) Sea with the Northern Ocean [22. XI, 6.1; 7.4], [22. XI.1.5]. "Moreover, according to them, the country is flooded with the Araks River, which, branching into many branches, flows in the north with all its other mouths into **another sea** (highlighted by the author) and only one mouth - into the Hyrcan Gulf" [22.XI,8, 6]. I.e. in the north there is a large body of water (another sea) at a fairly close distance, the Hyrcan Sea is its gulf.

In the writings of Dionysius Perieghet of Egypt [12. p.942.] "Oceanom" Eustace, in the Comments to the "Territory Dimension" Dionysius noted: "Under the Caucasus, it is now necessary to understand, they say, the northernmost part of the above-named Taurus, reaching the Kroni Sea" [12. p.938]. The northernmost part of the Taurus is the mountains of the Greater Caucasus, which overlook the Middle and Northern Caspian. Consequently, the Territory above the Southern Caspian (Hyrcan Sea) is the Kronian Sea (the Arctic Ocean, Ocean) according to ancient Greek sources. V.V.Latyshev also emphasized that: "263 [Posidonius calls the Caspian Sea as an Ocean, ...]" [12. p.466].

Nowadays scientists have concluded: "Under the North Sea, we meant two huge lakes: the Caspian and the Aral, perceived as one water basin" [3. p.285]. Moreover, "... both the ancient and Chinese authors did not have a clear idea about the Caspian Sea and separately about the Aral Sea (1. p. 56)" [2. p. 58; 8.].

According to the analysis of ancient sources, we concluded that the Middle and Northern Caspian was connected to the Aral Sea, and by its considerable size, in the ancient period, it seemed like a "different", "northern" sea, merging with the Ocean.

### **The image of the Caspian Sea and the mountains of the Greater Caucasus on ancient maps**

Ancient cartographic material does not have an unambiguous conclusion about the contours of the Caspian Sea. If the images of the Mediterranean, Black and Azov Seas were noted, in general, in accordance with their current state, then the image on the ancient maps of the Caspian Sea does not correspond in form to the modern Caspian Sea. Analysis of antique maps showed the following:

- the image of the Caspian Sea stretched from north to south occupied a smaller area than from west to east;
- on ancient maps the mountains of the Greater Caucasus went to the north-west and north of the Caspian (Hyrcean) Sea.
- Indeed, this is a mystery for geographical science. Moreover, there are no mountains in the north of the modern Caspian Sea.

On the map, drawn up according to the description of Hecateus Miletus, the sea is depicted as an oval, extending from west to east. Hecateus noted: "**around** the so-called Hyrcan Sea **the mountains are high ...**" [12. p.651]. This fragment assumes the existence of mountains in the north of the Caspian Sea.

And the phrase of Aristotle, "**under the Caucasus there is the lake, which the natives call the sea,**" [5.b.1.p.13.§ 29] suggests that the mountains were north of the Hyrcan Sea. Analyzing the maps of Ptolemy, we can note: - The Caspian Sea on the map is depicted in the form of a closed oval, stretched from west to east; in sizes it is not less than the Black Sea [12. p.651]; - on the map of Ptolemy, the Caucasus Mountains are located north of the Caspian Sea.

Strabo: "The Caucasian **ridge is surrounded from the north** by two seas, the Caspian Sea and the Pont" [12. X1.1. p. 402].

Pliny: "The Caspian Sea **is all surrounded** by the Caucasus Mountains" [16.VI.X.28].

According to the method of comparative analysis of ancient written sources and ancient cartographic material, we can conclude that the Hyrcan Sea was in the basin of the Southern Caspian Sea, in the north of which there was the overland Absheron threshold (the modern geological name of the uplift separating the Middle Caspian

depression from the South Caspian) as a continuation of the Caucasus, and in the south, respectively, the mountain chain of Elborz.

The significance, the linking of geographical objects with respect to each other and the countries around them emphasizes Strabo's words: "Only in this way can determine the points and precise borders, which geography needs. The borders of the country are precisely determined when it can be limited to rivers, mountains or the tribe or tribes, and finally, according to size and form where it is possible [22. b.II.1.30].

The length of the sea from west to east was much greater than from north to south, because: "... the sea level reached the point much higher than the present one, ... the most extreme points of which were, the western - on Kura, and the eastern - on Uzboi "[14. p.135]. The Absheron threshold separating the North and Middle Caspian from the South was leading to a rise in sea level and a shift of the coastline to the west and east.

Thus, based on the analysis of ancient Greek and ancient written sources, modern foreign and domestic works, analysis of ancient maps, we came to the conclusion that:

- The Hyrcan Sea was located in the basin of the modern South Caspian;
- The Hyrcan Sea was a closed nature, it was a lake;
- In the north of the Hyrcan Sea, the overland Absheron threshold was located, in the south - the mountain range of Elborz was located;
- The Hyrcan Sea from west to east was much larger than from north to south.

Analyzing the obtained data, we made an attempt to examine the ancient Caspian Sea, without denying the obtained facts only on the basis of "their inconsistencies with the current situation" [14. p.131].

### **Ancient sources about the existence of two seas: the Caspian Sea and Hyrcan Sea**

Ancient authors, speaking of the Caspian Sea, noted the presence of two reservoirs connected together. Aristotle emphasized two different seas: "... and the Hyrcan Sea and the Caspian Sea are separated from it altogether and settled along the entire coast" [5. b. II, Ch. 1]. V. Latysheva noted that: "257. Apparently, here Aristotle calls the southern part of the Caspian Sea the Hyrcan Sea, and the northern part of the same sea as the Caspian Sea" [12. p. 204].

Plutarch reported on a separate reservoir connected to the Hyrcan Sea: "Then Alexander with the best part of the troops went to Hyrcania. There he saw **the bay, the water in which was much less salty than in other seas. About this bay, which seemed not be inferior in magnitude to Ponto ...** " [17. 44, 1]. That is, a separate reservoir with rather fresh water and large in size, like the sea (the Black Sea).

Analyzing the ancient authors, the researchers note: "Patrokl was for some time under Seleucus Nicator and his son Antioch the ruler of the regions that are near **the**

**Hyrcan and Caspian Seas**; he studied these seas with the help of the fleet, apparently in order to investigate **the merger that once existed** and in order to find out how water trade with the peoples of Northern India can be organized here ... ” [12. p. 239].

Pliny [b.VI.XXI.58], Stephen of Byzantine (6th century AD) [12. p.831], Quit Curtius Rufa [11. b.VII, Chapter 3 .20, 21] called the Caspian Sea separately from the Hyrcan Sea.

In IV century AD Vasiliy the Great (Caesarea) noted: “IV, 4 (M., XXIX, 88). However, some think that both the Hyrcan and Caspian Seas **are enclosed in themselves**; but if only one should believe the descriptions of the narrators in any way, **they have mutual communication and all are connected with the greatest sea by narrow straits**” [12. p.759].

Based on the analysis of ancient sources and cartographic material, we came to the conclusion about the existence in antiquity of two reservoirs in the territory of the Caspian Sea:

- the Hyrcan Sea in the basin of the Southern Caspian, of a closed nature, stretched from west to south in the form of an oval, in the north of which the Absheron threshold is located, as a continuation of the mountains of the Greater Caucasus;
- The Caspian Sea, which occupies the basin of the Middle and Northern Caspian, designated in ancient sources as the North Sea, the Kronian Sea or the Ocean.

“After all, in many cases, the obviousness and consent of all evidence indicators are worth more than any tool” [22. II, 1.11].

### **The reflection of the "Caspian-Hyrchan isthmus" in ancient sources**

The conclusion about the existence of two reservoirs: the Caspian Sea and the Hyrcan Sea, separated by the Absheron threshold, which we call the Caspian-Hyrchan isthmus, brings a new emphasis to the history of the peoples of the Caspian region.

The tribes of Kolkhs and Iberians (Georgia), as noted by ancient authors and in modern studies, lived on the western coast of the Caspian Sea. Hyrcania was located in the southeast of the Hyrcan Sea. According to the present location of the Caspian Sea, there is no territorial border between these peoples. However, based on the data of Arrian (IV, 15.1.), Plutarch (Pompey. XXXIV), Pomponius Mela (III, 5, 41), Eratosthenes [20. p. 268], Quintus Curtius Rufus (B. VI, ch.5, 24.25), Dionysius Perieghet [12.s.548], Pristian “Land Surveillance” [2.c.55.], it was said that the massagets and the hyrcans were neighbors of the Iberians and Kolkhs.

Let us give a description of Eratosthenes, in which the Kolkhs are mentioned with the Hyrcania: “Who asserted regarding the distance from Amis through **Kolkhs and Hyrcania to the Bactria** and [people] on the other side of them who inhabited [the country] to the East Sea, that **it goes in a straight line to equinox east** (highlighted by

the author) and along the mountains remaining to the right of it? ". There is no deviation of the trajectory either to the north or to the south in order to circumvent the Caspian Sea. There is no mention of the sea route. By connecting on the map the line Kolkhis - Hyrcania - Bactria, which "**goes in a straight line to the equinox east**" [20. p.268], we will get the land Absheron threshold passing through the Caspian Sea.

Maybe Arrian was right when he quoted the words of the Khorezmian king Farasman, who asserted: "that he lives in the neighborhood of the tribe of Kolkhs and Amazons" (IV, 15.1.). If the possessions of Khorezm and Hyrcania along the Absheron threshold were connected with the "Massaget kinsmen" on the west coast, then he really was "a neighbor of the Kolkhs and Amazons".

The mention of hyrcans and bactras in the western part of the Caspian Sea was noted by the French scientist Claude Rapen [21, p.97], but Sara Ashurbeyli in their works "The History of the City of Baku" [6. p.13].

Taking into account the mobility of the peoples of that time, the nomadic way of their life, it can be assumed that at a certain period the population to the east of the Caspian, along the Absheron threshold, turned out to be in the western part of the Caspian Sea and then reached Iberians (the territory of modern Georgia).

### **Mention of the tribes on the Absheron threshold**

Strabo gives amazing messages in his two fragments: "... and, then **over the Hyrcan Sea**—the Scythians, Hyrcanas, Parthians, Bactras; Sogdians ... "[22. Book II, Ch.V, 31; 12. p.361]. And in the next report we read the mention of the tribes "**beyond the Caspian Sea** ... by the massagetes" [22. XI.VI.2]. This is evidenced, also, by the extraction from Mela from Pomponius [Book 1. Ch. II. A brief description of Asia. p.12].

It means that there was a territory that was at the same time across the Caspian Sea and over the Hyrcan Sea and where the tribes lived.

Taking into account that the western and eastern shores of the Caspian Sea were connected by land isthmus, in that historical period of time, the conclusion leads us to the Absheron threshold, i.e. - on the so-called Caspian-Hyrcan Isthmus.

Maybe Alexander Macedonian walked this way, as noted by Julius Solin: "XIX, 4.... then to the Caspian Sea, and from there **across the Caspian Sea** (highlighted by the author) **to penetrate** to the course of the river Kira, which flows along the border of Armenia and Iberia " [23].

This is confirmed by the route of Alexander the Great, indicated in cartographic form, on the basis of written sources of historians, the so-called "Vulgate". On a schematic map of the Caspian Sea in IV century BC, the Caspian Sea consists of two

parts: the Hyrcanic in the south and the Caspian in the north [21. p.114]. The dotted line between them is the Absheron threshold, which we call the “Caspian-Hyrcan Isthmus”.

### **Trade route through the Caspian Sea as part of the Great Silk Way**

The water-land trade route from India and China to the West, is described in details by ancient authors. This route of Indian goods to Europe is reported by Strabo (II, 1.15; XI, 7, 3) with reference to Patroclus, Curtius Ruf (VI, 4, 19), Varro (VI, 52) [2. . p.119], Guy Julius Solin [3. p.119].

According to Eratosthenes, who, while noting the road from the Black Sea to Central Asia, mentions "a passage along the Caspian Sea", or: "... to the mountain pass along the Hyrcan Sea" [20. p.268]. The mountain pass on the Hyrcan Sea is the Absheron threshold, i.e. the so-called Caspian-Hyrcanic isthmus.

Pliny notes: **“having reached across the Caspian to [the river] Cyrus, by land, taking no more than five days, it is possible to take Indian goods to Fasis in Pont”** [b.VI.XIX.52]. This fragment of Pliny, in our opinion, emphasizes the land route across the Caspian for five days. The closest distance between the western and eastern shores of the Caspian Sea is about 200 km. To overcome his caravan in five days is quite real. Moreover, it is illogical to get to the River Kir in order to go afterwards by land. Rather, on the river the transportation was on the water.

In the ancient works there is no description of the sea route. Moreover, one thing is to sail on the river, the other is to sail on the sea. Riverboats are not adapted to sea voyage. Moreover, ancient authors point out Caspian non-yielding, (Strabo, XI.7.2.), (Pomponius Mela, III, 5.38), and “Dionysius calls it difficult to sail” [12. p.942].

Opinions among researchers about the water-land trade route from India and China to Europe through the territory of modern Azerbaijan were divided polarly: “... some believed its real existence was Fr. Kruse, R. M. Vaidov, I. Yampolsky, T. I. Golubkina, M. M. Rasulova and others, other historians, in particular, V.V. Barthold, Ya. A. Manandyan, D.O. Thomson, V.V. Tarn, K.V. Trever, denied its existence ” [13. p. 67].

There is a memory of the isthmus in folk legends, as reflected in written sources: “Many Oriental historians call the Caucasus Albures. Katib Chelebi in Jahan-numa says that Al-Burs lies to the west of Bab al-Abwab, or Derbend, and **connects with a chain of mountains** (highlighted by the author) stretching from Turkestan to Hejaz [7. p.13].

The mountains from Elbrus and Derbend (the western coast of the Caspian Sea) to Turkestan (the eastern coast) could connect only along the Absheron threshold. Currently, the Absheron threshold is under water, and only the memory of the people, enshrined in the oral and mythological traditions, is able to remember past times when the Absheron threshold existed above the Southern Caspian (Caspian-Hyrcan Isthmus).

Abbas Gulu Bakikhanov, an eminent Azerbaijani historian, philosopher, poet, in the work “Gulustan-i Iram” devoted to the history of Shirvan and Dagestan, noted: “There was a legend between local residents that there was an isthmus from Baku to the Turkmen coast, through which Turkmen horse masses were coming here .. ” [7. c. 20-21].

### **Conclusions**

Analyzing the written Greek and Roman sources, cartographic material, there was made an attempt to explain the historical and geographical reality of the Caspian region, based on the geological features of the Caspian Sea at the turn of the first millenniums.

The analysis of ancient Greek and Roman sources leads to the conclusion about the existence of two water basins: the Caspian (Middle and Northern Caspian) and the Hyrcan (Southern Caspian basin) Seas separated by the land Absheron threshold.

The Absheron threshold, which we call the “Caspian-Hyrcan isthmus”, which is currently under water, in a historically definite period of time (presumably until the 6th – 7th centuries AD), was the land and connected the western and eastern shores of the Caspian Sea.

In ancient times, trade caravans, along the routes of the Great Silk Road, were going from China, India and other Asian countries to Europe, passing through the Caspian Sea along the isthmus.

## **Chapter II. Geographical aspects in the mythological tradition of the ancient Indo-Iranian peoples**

Operating with modern scientific data and analyzing the most ancient written sources, pointing out the rational grain in the mythological tradition of nations, one can closely approach the formation of a concept that will allow to concretize historical facts by place and time. The ancient written monuments that preserved the information on the history, culture and mythology of the Iranian and Indian peoples came to us as collections of sacred texts of the Rig Veda, Mahabharata, Avesta, and others, containing the names of many geographical objects: Mount Khara Berezite, Meru, Molochny Ocean, sea Vourukasha, the Fravcard Sea and others.

“Some researchers consider Zarathushtra (Zoroaster), who is credited with creating the main essays that formed the basis of Avesta and Zoroastrianism, as a senior contemporary of the Persian king Darius I (522–485 BC. This is the view of Hertel, Herzfeld, in the Soviet science - Academician V.V. Struve). Other researchers attribute

the addition of the oldest parts of the Avesta to much earlier time [7.S.50]. Myths about the Iranian mountains of Hara and Indian Meru have sources that are lost in the Proto-Aryan times, and suppose their localization in the far north.

"1. At first the mountain rose, Spitam-Zarathushtra, High Kharati rose on the ground that surrounds the country **from sunset to sunrise** " [Avesta. Hymn of Hvarno (Yasht 19, "3amyad-yasht") p.12].

In the ancient Indian source, "The Laws of Manu" it says: "On Meru the gods see the sun after its one-time ascent throughout its route, equal to half of its circulation around the earth" [4]. Comparison of the mountains of Khara Beraziti and Meru unambiguously leads to an understanding of their identity in the mythological tradition of the Aryan peoples. The underlined globality of mountains on a planetary scale, listing the names of the peaks, makes it possible to perceive the mountain Hara Berezayti as a continuous mountain system: "... while the other mountains, numbering two thousand two hundred and forty-four, grew out of (mountain) Alburs" [19. Chapter XII].

On the overview map the Alpine-Himalayan mountain system looks like a single mountain, covering the eastern hemisphere of the Earth.

This half of the Earth (Eastern Hemisphere) sun, indeed, passes from east to west in one light day (one-time ascent). In the east at sunrise at the Himalayan mountain system and at the end of the day at sunset near Spain.

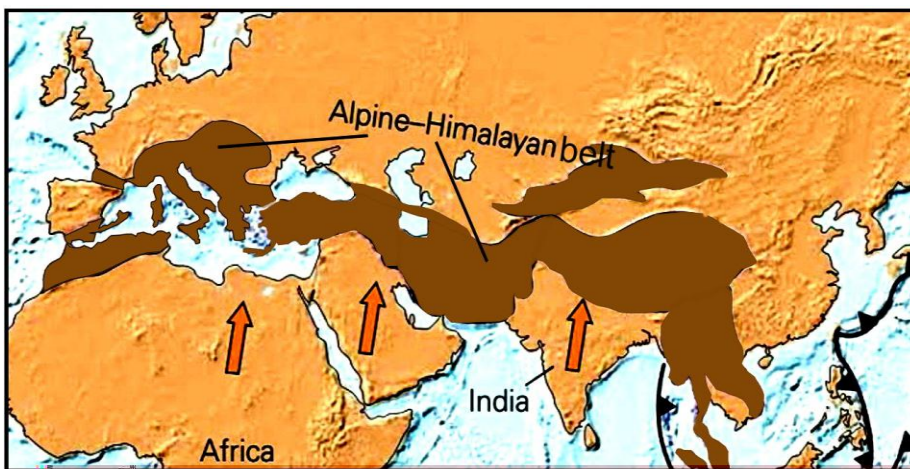


Fig.1. Overview map of the Alpine-Himalayan fold belt



"Seeing the sun bypasses Meru at **sunrise and sunset ...**". I.e. full compliance with "half of its circulation around the earth."

In the "Rig Veda" in the hymn in honor of the god of fire - Agni (5th hymn of the third book): "He (Agni) guards the desired top of Ripa, the place of the Bird; he, vigorous, guards the path of the sun; he, Agni, guards in the center (literally "at the navel") the **Seven-headed**; he, excellent, protects the fun of the gods "[3. p.37]. A large amount of information has been collected in the 5th hymn of the Rig Veda. The top of the Ripa Mountains, marked in Scythian and ancient Greek mythology, is noted as the Ripean Mountains, location of which is associated with the Caucasus Mountains: Dionysius Perieget [9. p. 948], Pomponius Mela [1, 19, 109], Gai Julius Solin XXXVIII, 11. [1. p. 48], Pliny [B. VI.V, 15], [8.p.80]. "We already know that the real basis for the idea of the legendary Ripaeian mountains for the ancient Greeks could probably be only the Caucasus, with its highest, wild and covered with eternal snow peaks. There were not other similar mountains in sight of the Greeks in the VI century BC. We also know that the name Ripeev itself is associated with the Caucasus through the biblical names of Rafa and Rifat, which are localized at the direction of the "Book of Jubilees" in the Caucasus" [18].

Another information in the Rigveda connected with the Caucasus Mountains is the place of **the Birds**. According to ancient Greek myths, Prometheus was chained to the mountains of the Caucasus, between the two peaks of Elbrus, whose liver was pecked by the Eagle. We see the origins of the ancient Greek myth in the Proto-Aryan, Scythian basis.

Thus, "the peak of **Ripa**, the place of **the Bird**" is Elbrus - the main peak of the Greater Caucasus. The following message in the Rigveda again points to the Caucasus. "... he, Agni, guards in the center (literally "at the navel ") the Seven-headed." A short message that includes information about the Greater Caucasus: "The Caucasus is divided into two parts, which are called the Greater and Lesser Caucasus. The first one extends from Taman almost to Baku and consists of the Western, Central and Eastern Caucasus. One and a half thousand square kilometers of ice, the highest point of Eurasia **Elbrus** (the top of the Caucasus Mountains), the iron mountain, and **six mountain peaks**, five thousand kilometers high - that's what the Big Caucasus is" [6]. If you look at the scheme of the Alpine-Himalayan mountain system, covering the entire eastern hemisphere, we will notice in the center of it that „on the navel“ the mountains of the Greater Caucasus stand out and its continuation the Absheron threshold, which corresponds to the ancient Aryan characteristic of the **seven** five thousandth tops of the **Seven-Headed**. The Absheron threshold divides the Caspian Sea into two parts: the Southern, Middle and Northern Caspian. In Chapter 1 we have already noted the

correspondence of the Southern Caspian to the Hyrcan Sea, and to the North and Middle Caspian to the North Sea, the Arctic Ocean, according to ancient Greek and Roman sources. In the ancient Persian and ancient Indian sources, the following water bodies are mentioned: the Milky Ocean, the Sea of Vourukash, the Sea of Fravcard. In the Indian epic poem "Mahabharata" there is the following geographical reference point: - At the foot of Meru - the "abode of the gods" is the Milky Ocean; [4].

Over the centuries, the inquisitive thought of humanity tried to determine the location of the Milky Ocean (Northern Ocean, or Sea), placing it, according to ancient Indo-Iranian legends, in the north. The inhabitants of India had a lively connection with the population of Central and Middle Asia, the Pamirs, Tibet, therefore they had information about the absence of a large water area to the north of the Himalayan mountains.

In the ancient Iranian "Avesta" we also see landmarks - the water space at the foot of the High Khara: "sea" ("zraya") named Vourukasha. Vourukasha is a legendary sea, with which, as with the mountains of Khara Berezayiti and the Ranha and Vahvi-Datia rivers, historical events are noted in "Avesta", where the name of the sea is mentioned many times: in "Yasna", "Vendicate", Yashtah (Ardivisur-Yashte, Tishtr-Yashte, and Zamyad-Yashte) [10]. In the Mahabharata: "The great sage and hero, the eldest of the Kauravas, Bhishma, telling about the country in the north, says to Yudhishtira: " The northern slope of Meru, the coast of the Milky Sea "[3 p. 18].

The origin of the name Milky or White Ocean is probably related to the feature of the Caspian Sea. "The NASA Aerospace Agency has published photographs of anomalous processes in the Caspian Sea - **"the milky whirlwinds"** off the coast of Turkmenistan. The pictures were taken by a MODIS spectroradiometer from the Terra spacecraft. The whirlwinds of light-turquoise sea water were caused by winds, which mix water and bottom sediments, **which gives the water a milky color** "[12].

Hence, phrases from the Avesta and the Mahabharata speak of a reservoir lying north of Meru (Hara Berezaiti). In Budaishn we read the description of Hara: "Hara Berezaiti itself is an island, it is surrounded from the east, north and west by the Arak and Vehrud rivers, and from the south by the Frahvard sea" [5]. Consequently, the Milky Ocean is to the north of Meru, and the Fravkard Sea is to the south of Meru (Hara Beresity). Mount Hara Berezaiti (Meru) in this fragment is the Absheron threshold, which until the middle of the 1st millennium AD was land, as we see on the overview map of the Alpine-Himalayan fold belt.

Fragments from Budaishn confirm that the Fravard sea corresponds to the Sea of Hyrcania, according to ancient sources, located in the basin of the modern Southern Caspian. "... the Sea of Frevkard occupies one third (of land) in the south, on the border with Alburs" [19. Ch. XIII. About the properties of the seas]. In the south of the Southern Caspian (the Fravard Sea), the mountains of Elborz are currently located.

A fragment also testifies to this: “Lake Chichast (is) in Adurbadagan (South Azerbaijan), (its) water is warm and harmless because there is nothing alive in it. Its source is connected to the lake Frakhvard” [19. Ch. XXII]. Lake Chichast (Urmia) is located in Azerbaijan and is connected with the sea (lake) Farhvard – it is the Hyrcan Sea with a closed-type feature (South Caspian Sea). The location of the Fravkard and Vourukash seas corresponds to the concept of the existence of the land Caspian - Hyrcan isthmus. The Caspian Sea was divided by the Absheron threshold (the Caspian-Hyrcan Isthmus): to the Hyrcan Sea or the Fravard Sea (Southern Caspian Sea) and the Caspian Sea - the Milky Ocean, the Sea of Vourukash (Northern, Middle Caspian Sea and, probably, the Aral Sea), which in ancient literature was called North Sea or Northern Ocean.

### **Chapter III. The Caspian Oycumen in the sphere of global interests of ancient China**

The trade caravan route from India and China to the West, and, in particular, on the territory of ancient Azerbaijan, attracted close attention from the world powers of that time, first Greece, later Rome, Byzantium, China, India and Parthia. Understanding the significance of this region in ancient global politics and economics, the world political elite sought to strengthen its influence in this region.

Purposeful policy of the Middle Kingdom (China) at the end of the 1st millennium BC. focused on solving their main tasks, and these are first of all the following:

- Search in the West for allies in the fight against the Huns (sunnui);
- assessment of the possibility of territorial expansion and, from this point of view, the weighting of the forces of the nearest states;
- expansion of trade in the north-western regions.

In the II century BC according to Chinese sources, the ambassadors of the Middle Kingdom were noted on the shores of the Caspian Sea. The first historical information about the countries of the Caspian region is presented by the great scholar of his time, Sima Qian, in the “Historical Notes” (“Shi Ji”). The acquaintance of China with the Western territory took place under the emperor of the Han Wu Dynasty (141 to 87 BC). The work of Sima Qian presents the results of the diplomatic activity of Zhang Qian, ambassador of the Han Empire to the countries of Central Asia in 139 BC. We find in the “Historical Notes” (“Shi Ji”) of Sima Qian in Chapter 123 of “Dayuan Le Zhuan-Description of Dayuan”, data about the Huns, about the peoples of Central Asia (Kangüis, Usuns, Dayuezhi, etc.). " [9]. In the 1st century AD The Chinese historian Ban Gu created an encyclopedic essay on the history of China, "Qian Han Shu" ("The History of the Early Han Dynasty"), covering 230 years (3 c. BC-1 c. AD), from the first Han Emperor Liu Bana and ending with Van Mann. “Special sections are devoted to

economics, law, science, literature, art, geographic descriptions, administrative division, etc.” [14]. The historian Fan E. made up in the 5th century Hou Han Shu (“The History of the Late Han Dynasty”). The historical chronicle included the period from the years of 25 to 200 AD [11]. In ”Shofanbeicheng” Khe Tsu-tao, a Chinese official and scholar from the times of the Qin dynasty of the 19 th century, in the narration of the Western Territory there is a report on the states of Kangju and Yancai (beginning of 1 thousand AD). The canonical collection on the history of 26 dynasties of China "Ershis shi" reflects events in the Middle Kingdom since 3000 BC until the rule of the Ming dynasty in the XVII century. The composition of the historical canon "Ershishi Shi" also includes "Shi Ji" and "Hanshu". The detailed statement in the reports of Chinese travelers and governors, the data about states and cities along the routes to the West says about a sufficiently extensive study of this region: “Then to the west of Dunhuang and to Lake Yanze (Lobnor) guard posts were everywhere set up, and in Luntai and Quili [settled] there were several hundred military settlers. There were established the posts of military commanders. The governor supervised the actions of Usuns, Kangju and other foreign states, sent messages to the court in case of changes. ” [11] Information about the Western Territory contains information about two seas located in this area: Sihai (West Sea) and Beihai (North Sea)

### **Chinese sources information about Sihai (West Sea)**

In the detailed reports the Chinese emissaries in the Son of Heaven report wrote that: “[the country of] Daiyuan is located from the Huns to the south-west, from Han - directly to the west; there is no less than ten thousand li from Han. Kantszyu is located in the north of them, Daiuezhi in the west, Dasia in the southwest, Usun in the northeast, and Ganmi and Yutian in the east. To the west of Yutian all the rivers flow to the west and flow into the Sihai (Western Sea)” [9. Ch. 123].

Zhang Qian's journey took place at the time when the Daiyuan state (“Davan”) occupied territory in the Fergana Valley with its capital in the city of Ershi (present-day Kokand).

If the state of Davan was located in Fergana, and Yutian was located from it in the east (to the west, from which all rivers flow to the west), then most likely, the Shihai or the Western Sea is the Hyrcan Sea, noted by ancient authors.

Scientists also singled out the Western Sea, as a separate one. “If we consider that, according to Zhang Qian, from Yutian (Khotan), which is on the east of Davan, the rivers flow to the west and flow into the western sea, which he clearly distinguishes from the northern one ...” [4. p.132].

Idea of geographical landmarks gives us “Maps of the Western Territory (Central and Central Asia) with successive dynasties from Han to Tang” [3 p. 315]. In the period of Sango (Three Kingdoms; V century) there remain the ideas about Kangyui where in

the west of Kangyu there is a lake with a river flowing into it from the south-west. This is, in all likelihood, the Hyrcan Sea, but the river flowing into it from the southwest is the Araks.

In the 5th century, the historian Fan E noted: "... **the Great State of Qin (Daqin) is located west of the Western Sea (Sihai)**, which is therefore called Qin Hai, and it alone manages the Western Territory and together with vassals makes raids and looting" [11].

To the west of the West Sea (Sihai) was located the territory of modern Azerbaijan, which in the ancient period served as the object of rivalry of world powers: Rome, Byzantium and Parthia. Periodically, this territory came under the influence of one or the other state. Probably, Chinese scientists included in the concept of Daqin (Rome) the territories under the protectorate of Rome, including the territory of present Azerbaijan. Perhaps that is why the Roman Empire Daqin "is located to the west of the West Sea (Sihai)."

We can observe this approach in another passage of Hou Han Shu -Westland. Chinese scientists, noting the proximity of "Alanlao" (former Yantsai) to the borders of the lands under the authority of the Roman Empire, noted that: "in the west it is tied to Dacin" [11. - 356].

### **Chinese sources about Beihai (North Sea)**

In Hou Han Shu it is noted: "355. Kantszyu State. The Kantszyu state (Kangju, Kangha) arose in the 2nd century BC. During its peak it occupied a large territory in the upper and lower reaches of the river Amu-Darya, including the region of Khorezm, as well as a number of other territories" [11]. In the reports on the nomadic possessions of Kangju, Chang-Qian further says: "Yancai is located almost 2,000 li from Kangui to the north-west. And this is nomadic possession; in customs it is quite similar to Kangyuy. Yancai is often identified with aorses. According to the customs, they are similar to Kantszyu, they can put out more than 100 thousand horse archers. They live by the sea with **low shores - Beihai (the North Sea)**" [9]. The detailed information about Kanp is contained in the "History of the Elder Han Dynasty", the Chinese historian Ban Gu in the middle of the 1st century AD: "... about the great lake having sloping shores. This is the North Sea" [6. § 2].

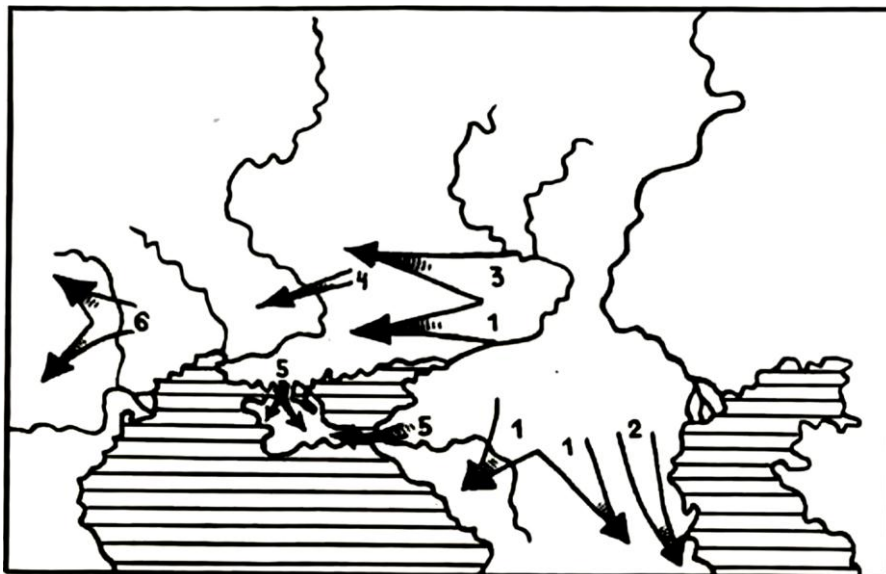
In Qianhanu, it is noted that Yancai adjoins "the great lake that has sloping shores. **This is the North Sea**" [1.p.34]. In addition of "Shofanbeichen" it is said about Yancai. "Others call Yancai Hesu. During the Han [ska dynasty] a message was open with him. In the west, adjacent to Daqin, in the southeast, over 2000 li adjacent to Kangju. There are more than 100,000 archers. With Kangyuy the same customs, and [country] is subject to Kangyu. Adjacent to **the Great Boundless Lake, this is the North Sea. On the high bank** there are a lot of firs and pines, white grass and sable,

graze cattle, follow water and grass. From the time of the Late Khan dynasty, they changed their name to the state of Alannago ” [12. Ch. 31, p. 18b.].

**Thus, we received the following information:**

- in the north-west of Kangyui (territory of Khorezm) is the possession of Yantsay;
- Yantsay was renamed into the state of Alannago;
- Yantsay is adjacent to the **“Big Boundless Lake, this is the North Sea”**.

Most scientists recognized the Yantsai affiliation to the aorses tribal union. “According to the German orientalist F. Hirt, the term Yancai represents the Chinese transcription of the name of Aorses. The conclusion of F. Hirth is shared by many scientists ” [5]. Aorse tribes (the state of Yantsai) controlled the Silk Road trade route along the northwestern part of the Caspian Sea. “Next come the nomads living between Meotida and the Caspian Sea, namely the Nabians and the Panksans, as well as the Sirac and Aorian tribes. ... they occupy a larger area, owning almost that most part of the coast of the Caspian Sea. Therefore, they made camel caravan trade with Indian and Babylonian goods, receiving them in exchange from Armenians and Medes; due to their welfare, they wore gold jewelry” [8. XI.V.8].



**Fig.2. A. Gabaraev History of the Alan.**

**Settlement of Sarmatian tribes (A.M. Khazanov):**

1. III - II centuries BC;
2. III -I centuries BC;
3. II century BC;
4. VI - I centuries of our era;
5. first centuries of our era.

From the 2nd century AD the Alans occupied a dominant position among the Sarmatians, pushing the Aorses away from this role. During this period, in the writings of ancient authors appears a new name of the country - Alania.

The state of Alanya existed in the I - III centuries AD in the territory of the Azov region, Ciscaucasia, and the northwestern part of the Caspian Sea.

Another important landmark: Yanci - "Adjacent to the Great Boundary Lake is the North Sea" [12. Ch. 31, p. 18 b.], "... to the great lake having sloping shores. This is the North Sea" [1. p. 34]. Chinese sources record the West Sea separately from the North Sea. Based on the fact that the Aorian tribes and the state of Alanya were located on the territory of the Azov region, Ciscaucasia, then the North Sea is the North and Middle Caspian. Opinions of researchers in the understanding of the question: "What is the" North Sea "divided. In particular: N. Ya. Bichurin (3. note 6) and R. Hennig (10. p. 266, note 2.) identify it with the Caspian Sea. While, V.V. Barthold (2. p. 32.) - with the Aral. "... according to Hou Han-shu, this is the first evidence of the ethnic territory of the Alans, called Alania, i.e., the country of Alans. Binding of this first in the history of Alanya to the "northern sea" is unconditional. Based on Sima Qian's instructions about 2 thousand li, separating Yancai from Kangüi, it is logical to see the Caspian under the "northern sea," and the Yancai region is mainly to locate in the Northern Caspian and between the Volga and the Don rivers [5].

Most researchers came to conclusion that the North Sea is the Caspian Sea. But, according to our conclusions, the North Sea is the connected together the Middle, North Caspian and Aral Sea, and the reservoir of the Southern Caspian is the Western Sea, according to ancient Chinese sources. Analyzing the trajectory of the route: Kangyui (Khorezm) - Yancai (Alannago) - Dacin (Rome) on a modern map, we can note that Kangyuy and Yancai could not be territorially in contact, as it was noted in the Chinese sources. Between them there is the Caspian Sea. At the beginning of the 1st millennium AD the Absheron threshold (we call it the Caspian-Hyrcan isthmus) was land and connected the western and eastern shores of the Caspian Sea, which is confirmed by Chinese sources. "Others call Yancai "Hesu". ... in the southeast over 2000 li adjacent to Kangüy " [13]. Analyzing the received data, we made an attempt to consider the history of the Caspian Oycumena and not to deny the facts, only on the basis of, "their inconsistencies with the current situation" [7.p.131].

Analyzing the Chinese sources describing the state formations, nature, peculiarities of culture and everyday life of Central Asia (Western Territory) and the Caspian Sea at the turn of the millennia we came to the following conclusions:

- The Western Sea (Sihai), considered in Chinese sources, is the modern southern Caspian;
- The North Sea (Beihai) is a reservoir uniting modern parts of the North and Middle Caspian Sea and the Aral Sea.
- Absheron threshold (called by us the Caspian-Hyrkan Isthmus) divided the North Sea (Beihai) from the West Sea (Shihai) [15-17].

### **Conclusion**

Based on ancient Greek, Indo-Persian and ancient Chinese written sources, archaeological, cartographic, geological, geophysical and natural-climatic information, we have proposed a new look at the history of the Caspian Sea and the Caspian Oycumena. The configurations of the Caspian Sea, at the present time, do not correspond to the description given by ancient authors, but also: "... the transfer of the current situation to such a distant past is illegal" [7. p.133]. Agreeing with R.Hennig's remark that: "The position of the Caspian Sea on the globe, throughout antiquity had been a riddle for geographical science" [10.v.1, ch. 26, p.244], we tried to solve it.

According to the physiographic conditions, the Caspian Sea is conditionally divided into three parts:

1. The Northern Caspian (25% of the sea area)
2. The Middle Caspian (36%)
3. The Southern Caspian (39%)

Until the middle of the 1st millennium of our era the Absheron threshold divided the Southern Caspian from the Middle and Northern ones, forming two reservoirs:

- The Hyrcan Sea (Fravkard Sea) and the West Sea (Sihai) are the Southern Caspian;



- Denoted in historical sources by various names: the Arctic Ocean, the North Sea, the Milky Ocean, the Warurkash Sea, the North Sea (Beihai) is the Middle and North Caspian Sea.

According to a number of authors [15-17], for tectonic reasons, the Absheron threshold descended into the water, giving the Caspian Sea a current look.

Control over the most important trade routes of the Great Silk Road was the basis for the rivalry of the great powers of that time - Rome, Byzantium, Iran, China, India, Parthia. The trade route from India and China through Central Asia, the Caspian Sea (along the Apsheron threshold) and Caucasian Albania to Europe connected the bundle of land, river and sea routes of the Great Silk Road. And here, the "Caspian-Hyrcan Isthmus" history has played the role of a bridge between Europe and Asia, confirming the reality of the functioning of the "Strabo Road". Involving many countries in the global political and economic circulation, the Great Silk Road led to the emergence of the first prototype of ancient economic globalism.

### References to Chapter I.

1. Aliev K.G. On the issue of the Caspian Sea and the Aral Sea in ancient sources. - in the book: Humidity fluctuations of the Aralo-Caspian region in the Holocene. - M.: Nauka. 1980, pp.56-61.
2. Aliev K.G. Ancient sources on the history of Azerbaijan. B. 1987.
3. Aliev K.G. Antique Caucasian Albania. B.1992. Cor.m. AN.R.A.I.G.Alieva.
4. Arriane Lucius Flavius. Per.Sergeenko M.E. M.Myth.1993
5. Aristotle METEOROLOGY. translation N.V.Braginsky. hspc.khazar.org/wp-content/uploads/2014/08/meteo
6. Ashurbeyli S. History of Baku. Baku 1992
7. Bakikhanov A. K. Gulistan-i Iram. Baku: Elm, 1991.
8. Bunyatov Z. M., Velikhanova N. M. The Caspian Sea in the Arab sources // News of the Academy of Sciences of the AzSSR. A series of history, philosophy and law, No. 2. 1988.
9. Herodot. History. (in nine volumes). General History ["Vexi" Library].
10. vehi.net/istoriya/grecia/gerodot/index.shtml
11. Elnitsky L.A. Knowledge of the ancients about the northern countries. M., 1961
12. Kvint Curtiy Ruf. The story of Alexander of Macedon. M.: MSU Publishing, 1993
13. Latyshev V.V. Proceedings of the ancient Greek and Latin writers about Scythia and the Caucasus // Herald of ancient history. - 1947. - №№ 1-4; 1948. - №№ 1-4; 1949. № 1-4. East.:
14. [Http://apsnyteka.narod2.ru/l/izvestiya\\_drevnih\\_pisatelei\\_o\\_skifii\\_i\\_kavkaze/index.html](http://apsnyteka.narod2.ru/l/izvestiya_drevnih_pisatelei_o_skifii_i_kavkaze/index.html)
15. Melikov R. Participation of ancient Albania in international trade. (Proceedings of the international conference "Strabo Road as part of the Great Silk Road". Baku, November 28-29, 2008). International Institute of Central Asian Studies, Samarkand - Tashkent, 2009 p. 67-80.
16. Novoseltsev A.P. The most ancient states on the territory of the USSR Materials and Research 1986.M.: Science, 1988

17. Dionys Periget Description of Oycumena. TR. Ilushechkina E.V. Herald of Ancient History, № 4/2005, № 1, 2/2006
18. Line Senior. Natural History, IV, 26, 29. Translation by V.Latyshev. VDI, 1949, №2.
19. Plutarch. Comparative biographies: In 3 t. Ed. Prepared by M.Ye. Grabar-Pasek and S.P. Markish-M.: Publishing House of the Academy of Sciences of the USSR, 1963.
20. Pompony Mela. On the position of the Earth. Antique geography. M., 1953
21. Claudius Ptolemy. Geography. According to V. V. Latyshev. Translation by I.P. Tsvetkov
22. Pyankov I.V. Central Asia and the Eurasian steppe in antiquity. S.-P., 2013.
23. Claude Rapen The trade route from India to Ponte to Strabo: between the cartographic mirage and the archaeological reality. (Proceedings of the international conference "Strabo Road as a part of the Great Silk Road". Baku, November 28-29, 2008) International Institute for Central Asian Studies. Samarkand - Tashkent, 2009 p.96-119
24. Strabo. Geography in 17 books M., publishing house Nauka.1964: 1994 tr. G.A.Stratanovsky under the general ed. of prof. S.L. Utchenko.
25. Guy Juliy Solin. Collection of memorable information. tr. I.I. Makhankova
26. Hennig Richard. Unknown land. v.1.ch.26.

### References to Chapter II.

1. Aliev K.G. Ancient sources on the history of Azerbaijan. B. 1987.
2. Avesta. [www.rulit.me/books/avesta-read-63923-1.htm](http://www.rulit.me/books/avesta-read-63923-1.htm)
3. G.M.Bongard-Levin, E.A.Grantovsky. From Scythia to India. Ancient Aryans: Myths and History, 2001
4. S. Volkov. The abodes of the gods. Mythical Mount Meru <http://www.dopotopa.com/>].
5. Mountain fantasy of plain inhabitants. <https://bovdo.livejournal./com/18921.htm/>
6. Caucasus Mountains - the highest in Europe: description, photo, video ... [webmandry / gory-kavkaza-samy-e-vysokie-v-evrope-opisanie-foto-video-kavkazs](http://webmandry / gory-kavkaza-samy-e-vysokie-v-evrope-opisanie-foto-video-kavkazs)].
7. M. Dyakonov History of Mussels. Book I Baku 2012. "Nagyl Evi"
8. Elnitsky LA Knowledge of the ancients about the northern countries. M., 1961
9. Latyshev V.V. Proceedings of the ancient Greek and Latin writers about Scythia and the Caucasus // Herald of ancient history. - 1947. - №№ 1-4; 1948. - №№ 1-4; 1949. №1-4. East.: [Http://apsnyteka.narod2.ru/izvestiya\\_drevnih\\_pisatelei\\_o\\_skifii\\_i\\_kavkaze/index.htm](http://apsnyteka.narod2.ru/izvestiya_drevnih_pisatelei_o_skifii_i_kavkaze/index.htm)
10. Localization of the Avestan Geographic Names ... [www.zoroastrian.ru/node/1535](http://www.zoroastrian.ru/node/1535) Magazine "Mitra" No. 9 (13) 2007. According to the materials of Nargiz Khojayeva, Dushanbe
11. Mahabharata. Edition VI. 1962
12. NASA showed anomalous processes in the Caspian Sea with <https://rg.ru/.../nasa-pokazalo-anomalnye-processy-v-kaspijskom-more-sosputnika.ht>
13. Dionysius Periget Description of the Oycumena. Tr. by Ilushechkina E.V. Herald of Ancient History, № 4/2005, № 1, 2/2006
14. Pliny the Elder. Natural History, IV, 26, 29. Translation by V.Latyshev. VDI, 1949, №2.
15. Pomponius Mela. On the position of the Earth. Antique geography. M., 1953

16. Ptolemy - Brief Description of a Map of Populated Land
17. Claude Rabin (France). Trade route from India to Pontus at Strabo: between the cartographic mirage and the archaeological reality.
18. North in the "Land Description" of Hekatheus of Miletus Submitted by agnostik on Sat, 09/08/2012
19. The creation of the basis (Bundahishn) and other texts. The publication is prepared by OM. Chunakova. - M.: Publishing firm "Oriental Literature" of the Russian Academy of Science, 1997. (Monuments of the written language of the East. CXIV)
20. Guy Juliy Solin. Collection of memorable information. tr. by I.I. Makhankova

### References to CHAPTER III

1. Aliyeva F.K. The culture of ancient Azerbaijan - Median Atropatena and Caucasian Albania (IV century BC - III century AD). Baku, Takhsil, 2007.
2. Bartold V.V. Soch., T. Sh. M., 1965
3. Bichurin N.Y. Collection of information about the peoples who lived in Central Asia in ancient times. T.P.M. — L., 1950.
4. Weinberg B.I. Ethnography of Turan in antiquity. M.: Eastern literature. 1999,
5. Gabaraev A. History of the Alan <http://iratta.com/alans/>
6. Lysenko N.N. the AS- the ALAN B CENTRAL ASIA (Central Asian aspect of the early ethnogenesis of the Alans). Vladikavkaz - 2001. Ch.3. §.2.
7. Novoseltsev A.P. The most ancient states on the territory of the USSR Materials and Research 1986. M.: Science, 1988.
8. Strabo. Geography in 17 books M., publishing house Nauka.1964 ,; 1994 per. G.A. Stratanovsky under the general ed. prof. S.L.Utchenko
9. Syma Qian Historical Notes. Eastern Literature [www.vostlit.info/Texts/Dokumenty/China/I/SymaTsjan](http://www.vostlit.info/Texts/Dokumenty/China/I/SymaTsjan)
10. Hennig R. Unknown Lands. V. 1. M., 1961
11. Hou Han Shu.Westland.- Alanica [www.alanica.ru/library/Houhanschi/Houhanschi.htm](http://www.alanica.ru/library/Houhanschi/Houhanschi.htm)
12. ENCYCLOPEDIA OF CHINA – Shofanbeicheng ” He Tsu-tao. Part I, Chapter 7.
13. [www.abirus.ru/content/564/623/626/14338/15081/15092.htm](http://www.abirus.ru/content/564/623/626/14338/15081/15092.htm)
14. ENCYCLOPEDIA of CHINA. He Qiu-tao. Addition from "Shofanbeichen"
15. 14.Encyclopedia of China - Ban Gu - Historical persons of China ... [www.abirus.ru/content/564/623/626/12557/12563.htm](http://www.abirus.ru/content/564/623/626/12557/12563.htm)
16. Tamila Sh. Khalilova, Renying Li, Elchin N. Khalilov. International Journal of Asian History, Culture and Tradition. Vol.4, No.4, pp.1-9, September 2017, 1-9.
17. Khalilova T.Sh.The Caspian-Hyrchan Isthmus — The Key Link in the «Strabo Road» as a Part of The Great Silk Road.Bulletin of the International Academy of Sciences. Russian Section. №1, 2018, 115-121.
18. Khalilova T.Sh., Khalilov E.N. The mystery of the merger of the two seas. Historical and geological research. SWB, Munich, Germany, 115 p.

## Avesta

The mythical tradition of Avesta keeps a reminder of the Global Flood. “(About) the properties of the earth, he says in Avesta, that (there are) thirty-three kinds of earth. On the day when Tishtar shed rain and when the seas appeared from this, the whole area, half filled with water, was divided into seven parts. The half part (of the whole area) is the center, and the six parts are around. These six parts are equal to Hvaniras, they were called (“keshwar”), and they are located side by side: thus, the part that is in the east of (Khvaniras) is Savagh keshwar, in the western part is Arzah keshwar, Fradafafsh and Vidadafsh, in the northern there are two parts, the keshvars Vorubarsht and Vooruzarsht, and the one that is central - Khvaniras. In Khvaniras there is a sea, as it is surrounded by a part of the sea Fravkard”. [Bundahishn. **Chapter XI. About the properties of the earth**]. Since the main catastrophic events associated with the end of the last ice period (the immense flooding of the Eurasian plains, the Bosphorus and Dardanelles and the coastal plains of the Mediterranean Sea) broke out between 12000-11640 years ago, it can be expected that these catastrophic events left their mark on the most ancient cultural monuments of nations. Indeed, the references to the "great flood" are found in Sumerian and Greek myths and Old Slavonic traditions. Apparently, the written sources have the same sources - Vedic and Biblical texts. The Keshvaras Fradadafsh and Vidadafsh have similarities in the sound of the “Fravvard Sea” (the Hyrcan Sea) and are located on the south of Hwaniras. The following fragment of Avesta speaks about the conformity of the Fravard Sea to the South Caspian Sea: “... he says in Avesta that the Fravard Sea occupies one third (of land) in the south, on the border with Alburs” [Budakhishn. **Chapter XIII. About the properties of the seas**]. According to this fragment, the Fravard Sea corresponds to the Hyrcan Sea, located in the basin of the modern Southern Caspian Sea, “in the south on the border” from which the mountains of Elborz are located. The following fragment also confirms this: “Lake Chichast (is) in Adurbadagan (its) water is warm and harmless because there is nothing alive in it. Its source is connected to the lake Frakhvard” [Budaishn. Ch.XX]. Lake Chichast of Adurbadagan is Lake Urmia in South Azerbaijan, the territory of which is adjacent to the South Caspian

Sea. The northern territories - Vorubarshht and Voruzarsht keshvars have a common root base with Vorukash lake (sea) and, possibly, covered the territory around the current Northern Caspian Sea. "From Vorubarshhta and Voruzarshta a high mountain has grown, so that no one can pass from the keshhvar to the keshvar." Maybe these are the mountains of the Urals, which divided the two northern keshvara. To obtain historical certainty, studying the data of ancient authors, containing, sometimes, contradictory information, the repetition of geographical names, perhaps by comparing additional, diverse sources.

## **HELENENDORF: THE GERMAN IMMIGRANTS OF AZERBAIJAN**

**Abbas Seyidov**

*Academician of the International Academy of Sciences – AS  
Azerbaijan State University of Economics, UNEC  
Baku, Azerbaijan  
[abbas.seyidov@gmail.com](mailto:abbas.seyidov@gmail.com)*

### **Summary**

The reasons and the way Germans migrated to Azerbaijan and established there the Helenendorf city in 1819, as well as their economy, belief, and culture are briefly portrayed in this article as a result of the authors investigations.

### **Abstract**

Helenendorf, the modern Göygöl city in Azerbaijan, was established by Germans in 1819. The city had a significant impact on the socio-economic development of the adjacent areas. The Germans continuously lived there more than a century until their exile by the Soviet Union in 1941. The reasons and the way the Germans migrated to Azerbaijan, as well as their economy, belief, and culture are briefly portrayed as a result of the authors own investigations.

### **Introduction**

Helenendorf, the modern city of Göygöl in Azerbaijan, was established by Germans in 1819. The city had a significant impact on the socio-economic development of the adjacent regions. The Germans continuously lived there more than a century up to their exile by the Soviet Union in 1941.

**Migration reasons.** Migration of Germans to Azerbaijan coincides political turbulences both in the South Caucasia and in Europe at the beginning of the 19<sup>th</sup> century.

While Europe suffered from the Napoleonic wars, Azerbaijan was split into two. The Gulistan treaty of peace of 1813, in Garabagh, Azerbaijan, as the result of the Russo-Persian war (1804-1813), initiated this division. All the territories to the north of the Aras river, except the Irevan and Nakhchivan khanates, were ceded to Russian control. On the other hand, the Bucharest treaty of peace of 16 May 1812, which ended the Russo-Turkish war of 1806-1812, admitted the fact of occupation of the South Caucasia by Russians (History of Azerbaijan, 2000, vol. 4, p. 34-37). The results of the further wars between Russia and Persia (1826-1828), and Russia and Turkey (1828-1829) completed the division of Azerbaijan by ceding Nakhchivan and Irevan to Russia (History of Azerbaijan, 1994, pp. 578-579, 623).

The population of the Kingdom of Württemberg, recently joined the German Confederation, faced the challenge to recover its economy. Mainly the poor Germans who found hopes with various religious branches were looking for an opportunity to move to the Caucasia to get closer to the Holy Land. According to Johann Christoph, one of the first immigrants, Germans wanted to move to a land of honey and milky rivers.

In 1816, the emperor of Russia Alexander I was passing Stuttgart when a group of Germans had the chance to meet him. Their settlement to Caucasia was approved by him, certainly in interests of Russia, which will be discussed in the next paragraphs.

**Migration process.** The German migration to Russia occurred between 1764-1842. Germans first arrived in South Caucasia in 1817. In 1816, forty families from Schwaikheim, Waiblingen led by Georg Friedrich Fuchs moved along the Danube, Odessa. In September 21, 1817, having followed the Kherson-Taganrog-Stavropol-Mozdok route, 181 people established Marienfeld – the first German settlement in South Caucasia, adjoining Sartichala village, near Tbilisi (Berge, 1874, vol. 6, part 1, doc. 425, p. 316; Zeynalova, 2002, p. 20; Auch, Eisfeld, & Konovalova, 2001). Due to Ibrahimov N.A., there were 40 families (Ibrahimov, 1995, p. 30). Then, major general Ismail khan Shekinsky of Azerbaijan provided them with 30 cows, 27 calves and 200 lambs (Auch, 1995, p. 106; Jafarli, 2003, p. 16).



**Fig. 1. The route of migration of Germans to Caucasia in 1817.**

On 10 May 1817, the Russian Diplomatic Mission informed the second influx of 7000 Germans in Stuttgart that each of them will be provided with passports of Russia due to the order of Alexander I. The 1400 families formed 14 groups, each having their own leader. All the groups were led by Johann Georg Frick, while the leader of the sixth group was known as Christoph Bidlingmaier.

The journey was terrible: the elderly and children, infants and ill people were gathered together. People had stomach-aches, and their faces swelled. Linens and clothes were dirty. They had no medicine except spirit to treat diseases. First cemeteries, as a result of mass stomach-aches, appeared at the banks of Danube. New cemeteries used to appear with subsequent migrations.

On 15 November 1817, Johann Georg Frick delegates two envoys to Moscow to report the tragic situation. He aimed to obtain the soonest possible permission to continue their travel to the Caucasia. This permission for 500 families was received on 20 February 1818, though some families decided to stay near Odessa. In addition, Alexander I instructed lieutenant general Aleksey Petrovitch Yermolov to cover all expenses of the Germans on their way. 500 families were equally divided into 10 groups. Each family received 500 rubles to buy horse and cart. Each person was given daily 40 kopeks for food, and 2 rubles for horse fodder. Besides, each group was supplied with a small medical kit.

The groups were travelling with an interval of 2-3 days. During this 60-day-long journey from Odessa to Mozdok, more than 200 people died and nearly 300 got diseases. A total of over 1000 died. In November 1818, only 500 families, approximately 2000 survivals, reached Tbilisi.

Thus, at the end of 1818, the second influx of migrants, who covered 4000 km distance, realized their dream. But with colossal losses! They were poor, hungry and without clothes, and winter was imminent. By the end of year, they established seven settlements within the 5-200 km distance from Tiflis: 84 families in Annenfeld (modern Shamkir), 118 families in Helenendorf (modern Göygöl), 60 families of handicrafts in Neu-Tiflis, 26 families in Alexanderdorf (modern part of Tbilisi), 12 families in Petersdorf (modern part of Sartichala), 65 families in Elisabeththal (modern Assureti), and 135 families in Katharinenfeld (modern Bolnisi) (Bidlingmaier, 2005).

Helenendorf was established in April 1819, at the land of the destroyed Khaniklar village. There is also a river called Khanik nearby. *Khanik* is one of the 24 Turkic tribes. The Seljuk khagan (905-1010) was the chief of the Khanik tribe.

**Economy and culture.** The German immigrants of South Caucasia were warmly met by Azerbaijanis. Due to the Order of the Committee of Ministers of Russia of 1818, each German family was given 35 dessiatin (1 dessiatin = 1.09 hectare) of land. The state also helped with house construction. In Helenendorf, 89 houses were constructed of stone in 1820. Nevertheless, during the Russo-Persian war of 1826-1828, their houses and agricultural facilities were largely damaged. The official sources indicate that a part of the population was killed, while the remaining part fled to the German settlements in Georgia. They returned to their lands after the war, and each family received 172 rubles for the house reconstruction. The aggregated amount for Helenendorf was 21,844 rubles, which clearly portrays that there were 127 families. Despite this, their situation was still very complicated by 1840s (Berge, 1874, vol. 6, part 1, doc. 481, p. 339; Berge, 1874, vol. 7, doc. 181, p. 233; Berge, 1874, vol. 7, doc 188, p. 240).

The Germans were mainly occupied with agriculture, including wheat growing, gardening, and especially viticulture. Besides, they showed great interest in sericulture, cotton-growing, rice-growing. For example, five boys were sent to Nukha (Sheki, Azerbaijan) to learn sericulture in 1841. The second half of the 19<sup>th</sup> century is marked by the second phase of economic development in German settlements of Azerbaijan. Thus, the market economy and capitalist relations developed. One of these spheres was farming, and specifically, cultivation of barley raised beer industry. Germans began the first beer plant at that time. As a result, Vohrers' firm was awarded the golden medal at the Caspian Areas Exhibition held in Baku in 1899.





**Fig. 2. The first known photo of Helenendorfers. Hummels family, 1863.**

Periodically, new German settlements, like Georgfeld in 1888 (modern part of Chinarli settlement, Shamkir district), Alexeyevka in 1902, Yelizavetinka in 1914 (modern Aghstafa district), Grünfeld (modern Vurghun settlement, Qazakh district), Eigenfeld in 1906, Traubenfeld in 1912 (modern Tovuz district), also during the Soviet period – Marksovka and Kirovka (modern Aghstafa district) were established in Azerbaijan (Jafarli, 2003, p. 17).

In the second half of the 19<sup>th</sup> century, the viticulture industry and large vine institutions were related to Vohrers, and Hummels. Vohrers established the liquor business in 1860. A decade later, their enterprise bore the name “Christopher Vohrer and sons” (*orig.* Christopher Vohrer und Söhne) since 1870, which was renamed to “Vohrer brothers” (*orig.* Gebrüder Vohrer) in 1892, when Christopher Vohrer passed his economy to his sons Christoph, Friedrich, Gotlieb, and Henrich. They exported their liquor to various countries. In 1868, Vohrers constructed a plant for beer production, which was marked as the second after the beer plant in Baku. As their business expanded, “Trade House of Vohrer brothers” (*orig.* Handelshaus der Gebr. Vohrer) opened representations in Yelizavetpol, Tbilisi, Baku, Batumi, Merv, Kars, Alexandropol, Ashgabat, Krasnovodsk, and Tomsk. Their products were awarded golden medals at international exhibitions.



In 1843, many immigrant Germans believed that the end of the world will come soon, and the god wants them to move to Palestine with the religious (spiritual) leader Warwara Spohn. They decided to sell their properties and depart for Palestine from Yekaterinenfeld. The government sent troops to prevent this day by day growing movement, however, allowed to delegate three representatives to Palestine to investigate the place. The representatives returned in June 1843, informing the people that the desert climate of Palestine is not preferable for their settlement. The separatist activity gradually abated, and those converted to Evangelist-Lutheran Church. The Germans were labelled as separatists and sectarians in the documents of the first half of the 19<sup>th</sup> century, and as Lutherans in further documents. The present church in Helenendorf was founded on 24 April 1854, and solemnly commissioned with five cannon fires on 10 March 1857. The ceremony was attended by the visitors from other German settlements and the government members of the Tsardom of Russia (The State Historical Archive of the Republic of Azerbaijan, f. 508, op. 1, d. 436, list 26).

Education was another developing cultural sphere.



**Fig.4. German Church in Helenendorf,  
1908.**

The first school was founded as soon as the first settlement in Helenendorf was established in 1819. Johann Jacob Kraus was the first teacher of the school. Another school was constructed there in 1842. On 22 November 1890, these schools became subordinate to the Ministry of National Education. A source dated 1906 portrays, that the 2-room school found in 1892, has 396 pupils (205 girls and 191 boys) and 5 teachers. Initially, the studies were conducted in German, later on in Russian (The State Historical Archive of the Republic of Azerbaijan, f. 830, op. 1, d. 7, list 8). In 1924, a school for deaf-dumb children was established. There were remarkable advances in the socio-cultural spheres too. Germans celebrated the semicentennial anniversary of the foundation of their settlements in April 1869. A library functioned in 1870, in Helenendorf that consisted of German books. Music received due attention (we were thrilled by 72-year-old Victor Klein's piano performance). Children learned to play the fortepiano and violin. "Women Charity Society" was instituted in 1909.

Healthcare was one of the primary issues. Drugstore, medical station, and hospital functioned in all the settlements. The first drugstore in Helenendorf was opened in 1888, and it specialized in the preparation of medicines from herbs (The State Historical Archive of the Republic of Azerbaijan, f. 61, inv. 1, case 299, sheets 85-86).

The sources show that the number of families in Helenendorf increased from 118 to 172 in the 60s of the 19<sup>th</sup> century (Verdieva, 2005, p. 28). By the end of the century, the population reached 1630 people (Brockhaus & Efron, 1894, p. 601).

In 1911, 415 of 1054 buildings in Helenendorf were dwellings. Fifteen special properties were built during 1911-1913 (Central Library of the Göygöl District, 2017).

Vohrer brothers could easily communicate via Ericsson radiophones with their employees at the Karayeri vineyards 15-25 km away from Helenendorf at the end of 19<sup>th</sup> and beginning of 20<sup>th</sup> centuries.

In 1912, the first water power stations were constructed in Surakhany, and in Helenendorf on the river Ganjachay. The substation located on the part of the city closest to the riverbank regulated and provided electricity to the city. The "ZurGES" power station near Zurnabad village that supplied electrical power to the surrounding villages was commissioned in 1928, as a result of hard efforts of the Germans.

One of the 120 deputies of the Azerbaijan Democratic Republic (1918-1920) was allocated to the representative of Germans, Lorenz Jakobovich Kun from Helenendorf (Zeynalova, 2001). On 9 June 1919, the Germans celebrated the 100<sup>th</sup> anniversary of the establishment of Helenendorf with the special permission of the Ganja governor.

"The Production Cooperative of Viticulturists and Winemakers of Ganja District" – "Concordia" was established on 8 August 1922, on the base of the production association of viticulturists and liqueur-makers that functioned since 1920. This was the only solution, though for a while, for the tough economic situation emerged in German settlements after the October revolution. It had branches in Baku, Tbilisi, Moscow, Kiev,

Leningrad, Rostov, Tashkent and other cities. By 1928, products of “Concordia” were distributed to Berlin, and more than 183 retail offices in the USSR. Part of the profit was spent on the development of science and culture (Auch, Eisfeld, & Konovalova, 2001, p. 14).

However, in 1925, the first criminal case against “Concordia” was settled, as its activity made the government of the USSR feel anxious. In 1934-1935, dozens of people were arrested as a result of the revision of economic activity of “Concordia”. The subsequent mass repressions ended up with liquidation of “Concordia” and many persons being arrested (Jafarli, 2003, pp. 28-51). It is necessary to note the scholar activity of Jacob Hummel when speaking about the development of science. Hummel was one of the founders of the archaeological science in Azerbaijan. He was born in Helenendorf in 1893, and studied in Tiflis, and Petrograd. He established the Regional Study Museum in Helenendorf in 1927. Academician linguist Viktor Zhirmunsky’s note in the memory book of the museum says: “The Helenendorf Museum, established thanks to the courage, historical vision and labour of Jacob Hummel, must be an example for every scholar as a high-valuable monument”. Hummel conducted archaeological excavations since 1930. He was the correspondent member of the Institute of Caucasian Studies, Academy of Sciences of the USSR, in 1936. He authored more than 80 articles and one book. Hummel was exiled to Akmola province, Kazakhstan in 1941, and died there in 1946 (Seyidov, 2011, p. 156).

**Exile.** The fate of Germans was questioned soon after Hitler’s army attacked the USSR on 22 June 1941. In Autumn, nearly 145 889 Germans were deported from northern Caucasia. (Auch, Eisfeld, & Konovalova, 2001, p. 19). The State Committee of Defence adopted the Decree dated 8 October 1941, requiring the deportation of the Germans from Georgia SSR (23 580 people), Azerbaijan SSR (22 741 people), and Armenia SSR (212 people) to Kazakhstan during 15-30 October 1941. All the Germans were exiled, except those whose husband was not German (Jafarli, 2003, pp. 309-313). Each family member was allowed to take 200 kg weight along. The remaining properties and livestock were distributed to kolkhozes. All the Germans were supposed to be delivered to Krasnovodsk of Turkmenistan via railway and by sea. However, they had absolutely no idea where and how they are taken. They could not even imagine being carried to Kazakhstan in freight trains. They were under strict control during this very long and hard road. The meal was served twice a day. Part of them died due to diseases, cold, starvation, and hard conditions. The final destinations were the provinces of northern Kazakhstan, like Akmola, Karaganda, Kostanay, Pavlodar (Zeynalova, 2002, p. 193). They were settled in special settlements under a special regime. Thus, the aggregate number of Germans deported from Caucasia exceeded 192 thousand. Years later, the special supervision over Germans was disaffirmed by the Decrees of the Presiding Board of the Supreme Soviet of the USSR dated 1955, 1964, and 1972.

Finally, in 1989, Germans and the other exiled nations were granted full freedom by the decisions of the Supreme Soviet of the USSR (Auman & Chebotareva, 1993, pp. 177-179, 266-267). But it was too late, the wheel of history could not be reversed. Part of the German population scattered throughout the deserts of Kazakhstan had already perished. Majority of the survived Germans moved to Germany. Only 748 Germans lived in Azerbaijan due to the census of 1989. Today, they are full-fledged citizens of the Republic of Azerbaijan. Taking into consideration the great importance of Azerbaijan as a centuries-old tolerant land with multicultural traditions, President of the Republic of Azerbaijan Ilham Aliyev signed the Order of 30 August 2016, which delegated the governmental institutions in co-operation with ANAS to prepare a special program on events dedicated to the 200<sup>th</sup> anniversary of the German settlements in South Caucasian region.

**German cemetery.** A German cemetery is located at the south of Helenendorf, modern Göygöl. The cemetery is of 190 m width, 200 m length. A special part is divided for the German, Austrian, and Hungarian captives of 1944-1947. Assyrians of Helenendorf were also buried there.

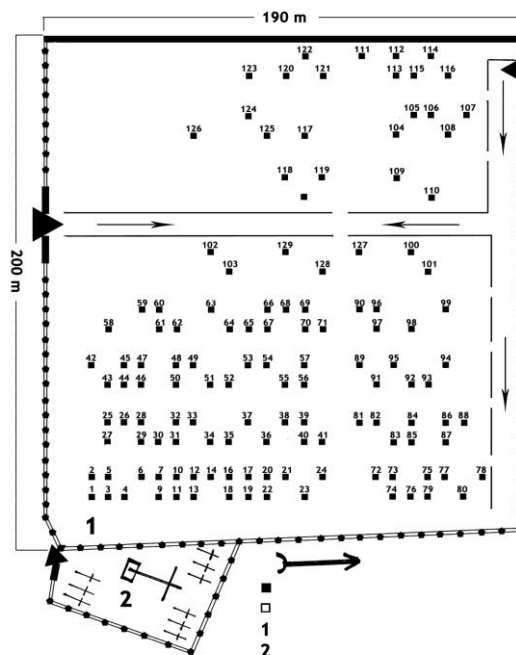


Fig. 5. Scheme of the German cemetery.

During the exploration of the cemetery by the author in July 2006, names, and dates of birth and death inscribed on 126 gravestones were recorded in numerical order, photos were taken, and their exact location was documented.

A copy of the document was sent to State Cinema-Photo Archive of the Republic of Azerbaijan, and the other copy to Scientific Archive of the Institute of Archeology and Ethnography of ANAS.

The general plan of the cemetery was drawn and the places of destroyed German graves were identified. There were over 500 fir trees aligned. A water supply line was laid up to the cemetery from the city. A heavily crumpled cash box was found there. Apparently, the visitors used the cash box to contribute to the expenses of the cemetery.

The shapes of graves vary. Traditionally, the tree-shaped ones belong to the persons who died young. The smaller of the two sanduga-type graves belongs to a child (1859-1860), while the bigger belongs to an adult (1824-1860). Apparently, they died at the same time in an accident.

The Osterle family was among the most unfortunate, as grave N15 Uranbio Osterle (1907-1909), grave N16 of Udolf Osterle (05.1902-07.1902) and grave N26 of Gerbert Osterle (01.01.1904-03.01.1904).

The second German cemetery is located approximately 2-3 km. to the West from Helenendorf. It belongs to German, Austrian and Hungarian captives of 1945-1948. Its dimensions vary in parts, between 50-100 m width and 100-150 m length.

### **Conclusion**

The Germans who lived in Helenendorf, Azerbaijan between the years 1819-1941, and found Helenendorf (modern Göygöl), passed through a great historic path in economic, cultural and business spheres. Upon the establishment of the Soviet Union, repressions started and Germans had to bear all ill treatments of the USSR government. Liquidation of “Concordia”, established in 1922, had a negative impact on the economy of Germans. Germans contributed to the cultural sphere as well.

They opened schools, clubs, held cultural events, and etcetera. The situation of Germans of USSR deteriorated due to the animosity between German and USSR governments. Their history and culture are subject to investigation today. The territory of modern Göygöl city is constantly developing under the direct supervision of the government.

The historic, cultural, socio-economic life of Göygöl region cannot be encompassed just in one work. The further explorations will unveil new facts and arguments about the past of the inhabitants of this region.

## Discussion

The Tsardom of Russia had its own interests in allowing the Germans to move to Caucasia. Their immigration policy had its roots from the period of Peter I (1701-1725). Immigrants had various professions, such as scientists, teachers, doctors, painters, architects, engineers. This process even more intensified in the second part of the 18<sup>th</sup> century. Catherine II (1762-1796) issued Manifest on 22 June 1763, envisaging resettlement of Germans to Russia by granting additional privileges for German colonies.

Another goal was evolving the culture of the population of the empire, and developing economy, especially agriculture. Caucasia was the strategic point for the Russian Empire.

Therefore, the government intended to create a buffer zone between Russia, Turkey, and Iran, and to settle there as many non-Muslim populations as possible. Rolf Bidlingmaier (2005) writes that the wife of Alexander I, the emperor of Russia, was princess Elizabeth of Baden, Germany.

The sister of Alexander I, Catherine, was the wife of the king of Württemberg Friedrich Wilhelm. This relation created favourable conditions for the solution of the migration issue.

The sources give contradictive information about the numbers of Germans arrived in Caucasia from Württemberg. Whilst Ibrahimov (1995, p. 29) reports 488 families, Eva-Maria Auch (2001, pp. 73-74) notes 480 families, 1923 people, or precisely, 49 families, 200 people were settled in New Tbilisi, 23 families, 99 people – in Alexanderdorf, 65 families, 307 people – in Elisabeththal, 17 families, 81 people – in Petersdorf, 102 families, 350 people – in Yekaterinenfeld, 73 families, 237 people – in Annenfeld, 120 families, 501 people – in Helenendorf. The worsening political situation between Germany and Russia, especially during World War I (1914-1918), aggravated the situation in German settlements of Caucasia. This is also clearly seen from the decision of the Russian government, adopted in 1916, on renaming German settlements to Russian. Thus, Helenendorf was renamed to Heleneno (until 1930), Annenfeld to Anneno, and etc. Another Decree of 1916, prohibited studies in the German language. Meanwhile, 800 Assyrians were moved from Turkey to Helenendorf in 1915-1916, upon the special invitation of the Russian general Tsitsianov. The land ownership rights of Germans were abolished in 1917.

Rumours about the exile of the Germans spread during the World War I. Luckily, the February Revolution, and the October Socialist Revolution of 1917, and ratification of the Treaty of Brest-Litovsk (1918) prevented this exile... until that dreadful year of 1941.



## References

1. Auch, E.-M. (1995). Nemetskie kolonisti v Zakavkazye [German colonists in the Caucasus]. In Rossiyskiye nemtsi na Donu, Kavkaze i Volge [Russian Germans on the Don, the Caucasus and the Volga] (p. 358). Anapa: International Association of German Culture.
2. Auch, E.-M. (2001). Öl und Wein am Kaukasus: Deutsche Forschungsreisende, Kolonisten und Unternehmer im vorrevolutionären Aserbajdschan [Oil and wine in Caucasus: German explorers, colonists and entrepreneurs in pre-revolutionary Azerbaijan]. Wiesbaden.
3. Auch, E.-M., Eisfeld, A., & Konovalova, O. (Eds.). (2001). "Konkordiya". Proizvodstvenniy kooperativ vinogradarey i vinodelov Gyandzhinskogo rayona ["Concordia". The production cooperative of winegrowers and winemakers of Ganja district]. Odessa: Astroprint.
4. Auman, V., & Chebotareva, V. (1993). Istoriya Rossiyskikh nemtsev v dokumentakh (1763-1992) [History of the Germans of Russia in documents (1763-1992)] (Vol. 1). Moscow: International Institute of Humanitarian Programs.
5. Azərbaycan Respublikası Dövlət Tarix Arxivı [The State Historical Archive of the Republic of Azerbaijan]. (n.d.). Baku, Azerbaijan.
6. Azərbaycan tarixi [History of Azerbaijan] (Vol. 4). (2000). Baku.
7. Berge, A. (Ed.). (1874). Akty, sobranniye Kavkazskoy Arkheograficheskoy Komissiyey [Acts collected by the Caucasian Archaeographic Commission]. Tbilisi.
8. Bidlingmaier, R. (2005). Tyazhelaya doroga na Kavkaz. Partner(4 (91)).
9. Brockhaus, F., & Efron, I. (1894). Yelenendorf [Helenendorf]. In Entsiklopedicheskij slovar [Encyclopedic Dictionary] (Vol. 11a). Saint-Petersburg.
10. Bunyadov, Z. M., & Yusifov, Y. B. (Eds.). (1994). Azərbaycan tarixi [History of Azerbaijan]. Baku.
11. Central Library of the Göygöl District. (2017, April 28). Helenendorf haqqında [About Helenendorf]. Retrieved from Vahid Merkezleshdirilmish Kitabxana Portalı [Portal of Unified Centralized Library]: <http://goygol.cls.az/more/text/50892>
12. Ibrahimov, N. (1995). Nemetskie stranitsy istorii Azerbaydzhana [German pages of the history of Azerbaijan]. Baku.
13. Jafarli, M. (2003). Politicheskij terror i sudba azerbaydzhanskih nemstev [Political terror and fate of the Germans of Azerbaijan] (2nd ed.). Baku.
14. Seyidov, A. (2011). Göygöl. Baku: Elm.
15. Verdieva, H. (2005). Pereselencheskaya politika Rossiyskoy imperii v Severnom Azerbaydzhane v XIX - nachale XX vekov [Migration policy of the Russian Empire in Northern Azerbaijan in the 19th - early 20th centuries]. Baku.
16. Zeynalova, S. (2001, 11 03). Iz protsvetayushih koloniy – v spetsposeleniya NKVD [From the flourishing colonies to the special settlements of the PCIA]. (209). Newspaper «Зеркало» ["Zerkalo"].
17. Zeynalova, S. (2002). Nemetskiye kolonii v Azerbaydzhane (1819-1941 gg.) [German colonies in Azerbaijan (1819-1941)]. Baku.

## **CASE OF CATALONIA: A RETURN OF THE ISSUE OF SELF-**

**Kamal Makili-Aliyev**

*Faculty of Law, Lund University, Sweden*

*"In Republics, the great danger is, that the majority may not sufficiently respect the rights of the minority."*

*James Madison*

### **Summary**

The issue of self-determination returns as a negative factor to the European context that can harm the European legal system through the case of Catalonia.

### **Abstract**

The case of Catalonia have rocked the European legal system in 2017 with the separatist attempt of the autonomous government of Catalonia to secede from Spain. However, the effects of this situation on the European legal system were not sufficiently studied or discussed in academia. This article explores the international legal side of the case of Catalonia and its effects in the European context. The articles studies this question through the prism of the self-determination as a principle of international law and its applicability in the case of Catalonia. It then attempts to compare Catalonian case with other similar cases in the European context and draw appropriate conclusions.

### **Introduction**

It was October 30, 2017 when several Catalan politicians fleeing the Spanish government landed in the Belgium capital. This moment marked a very sharp phenomenon that have not been experienced in European context since the beginning of 1990-s. A stark political conflict based on the issue of self-determination.

For several decades Catalonia, an autonomous region of Spain, have been governed by *Generalitat* with a large measure of self-governance. However, rising pro-independence movement on par with a financial crisis, that have been shaking Spain in recent years, led to the point in history that ended with the proclamation of independence of Catalonia. That proclamation made by Carles Puigdemont, president of Catalonia and leader of the movement for independence, led to the Spanish authorities discarding it as

unconstitutional and issuing arrest warrants for political leadership of Catalonia and simultaneously installing a direct administration in the autonomous region.

On November 3, 2017 Spanish authorities have issued a European Arrest Warrant (EAW) for Puigdemont and others, who later submitted themselves to the Belgian authorities. Spain have recalled the EAW in December 2017, only to reissue it in March 2018 for Puigdemont, who at the time was in Germany with no possibility to travel and waiting for the prosecutor's decision on the corruption charges against him raised by the Spanish EAW.

If Carles Puigdemont hoped to find support from other states in the European Union (EU), he has obviously miscalculated. EU and its member-states offered condemnations instead of support and so did the U.S. /2/ The unilateral declaration of independence of Catalonia was based on the referendum that took place in Catalonia on October 1, 2017. Spanish authorities' position was that this referendum was illegal and that led them to the use of administrative and power measures in attempt to prevent the conduct of voting in Catalonia. Spanish authorities have managed to conduct arrests and ceased some ballots, however were not able to effectively prevent the referendum. The results were low (43%) turnout and 89% of support for independence with some voting irregularities. /3/ This gave a Spanish government even more space to rain criticism on the authorities of Catalonia and their leader. After the referendum, the government's dialogue with Catalonia was in the language of ultimatums.

While Puigdemont tried to maneuver away from head-to-head confrontation after the referendum, proposing the suspension of its effects to engage in dialogue with central authorities, Spanish government, in its turn, threatened with responsibility and invocation of the constitutional provision (Article 155), that was never used before, to establish direct rule over the region and dismiss the local government. Authorities made good on their threats after the unilateral declaration of independence finally took place on October 27, 2017. In February 2019, Spanish authorities started trials of the Puigdemont supporters and colleagues from former Catalonian authorities while still seeking the extradition.

It is obvious that this situation is going to have long lasting consequences for the future of Europe. European Union is already struggling with several critical issues that are not just idle barriers to be conquered in order to achieve greater unification, but fundamental challenges that threaten the existing order. The mere fact that crisis in Catalonia has a cornerstone of the issue of self-determination in its context, adds another fundamental challenge to the future of EU. It truly seemed that after the dissolution of USSR and former Yugoslavia the issue of self-determination in its external context (that may lead to secession) have taken a rightful place on the dusty shelves of history of Europe. The case of Catalonia obviously begs to differ.

Hence, the purpose of this paper is to examine the situation in Catalonia a bit closer from the point of view of international law and find out if self-determination is back as a legal issue in the European context based on this particular case. To discuss the case of Catalonia more thoroughly, the paper will first review the self-determination as a principle of international law with regard to the European context. It will draw distinctions and parallels between external and internal self-determination examining it both in European and Catalonian context and then compare the case of Catalonia with other prominent examples of autonomies in Europe in order to show the differences in context and main issues. The paper will then attempt to explain the possible impact of the case of Catalonia on the future of Europe and identify the possible reasons of the emergence of this problematic situation in this region and in comparison with other such European regions that theoretically risk the self-determination crisis.

### **Self-Determination as a Principle of International Law in the European Context**

The right of self-determination was linked to the expression of will and people's sovereignty since the Age of Enlightenment. /4/ However, it did not solidify as a universally recognized principle of international law until 1960-s when it became the main basis for the abolition of colonialism. Despite the fact that self-determination as a principle was still fiercely debated among the states, UN General Assembly was able to adopt a resolution 1514 (XV) on the Granting of Independence to Colonial Peoples (December 4, 1960). This and similar UN documents of that time period explicitly proclaim the right of self-determination of colonial peoples. Later, in its advisory opinions, the International Court of Justice (ICJ) states that self-determination with the development of international law, became not just a guiding principle, but a legal right of its own standing. /5/ The subsequent development of this right led to its inclusion into the customary international law as *jus cogens* rule, thus securing it as widely accepted by the international community. /6/ It is important to note at the same time that the right to self-determination has a perceived limit in form of principle of territorial integrity that can be found in UN Charter Article 2(4). Right to self-determination in international legal instruments is usually reaffirmed in conjunction with the corresponding statements on safeguarding the territorial integrity of states. In this light, the Supreme Court of Canada stated quite fairly that the evolution of the principle of self-determination was within the framework of respect for the territorial integrity of the states. /7/

The legal roots of the right of self-determination lie in the fundamental international treaties of the UN. The principle itself has been transformed from the political idea into the legal principle of international law with the adoption of the UN Charter. Article 1(2) of the UN Charter enshrines the respect for the principle of equal rights and self-determination of peoples and proclaims it as a foundation for the friendly

relations between states. Moreover, common Article 1(1) of the subsequent International Covenant on Civil and Political Rights (ICCPR) and Covenant on Economic, Social and Cultural Rights (ICESCR) of 1966 declares that all peoples have a right to self-determination and that this right presupposes their ability to determine their political status and pursue their economic, social and cultural development freely. Thus, ICCPR and ICESCR being a part of International Bill of Human Rights confirm the right of self-determination as a basic human right. Furthermore, the wording of the Covenants determines that right to self-determination has political as well as economic, social and cultural aspects. The predominant view in the doctrine is that the right to make decisions on the political status includes not only basic determination of the internal status, but the external status as well, which may lead to the possibility of secession. /8/ Secession is one of the most disputed issues in the international law, but at the same time, it is truly hard to disagree with the observation of the former UN Secretary General Boutros Boutros-Ghali in 1992 in the Agenda for Peace when he stated that: "The United Nations has not closed its door. Yet if every ethnic, religious or linguistic group claimed statehood, there would be no limit to fragmentation, and peace, security and economic well-being for all would become ever more difficult to achieve". /9/

In line with that statement there is also a lot of skepticism among the authors about the actual 'right to secession'. For example William Slomanson discussing Nagorno-Karabakh makes following statements: "There is no multilateral treaty on secession. There never will be. That would be political suicide. An alternative source of international law - state practice - does not provide an expedient yardstick for measuring the legitimacy of unilateral secessions... [T]he right to self-determination does not include a general right to secession..." /10/ The same view is shared by Heiko Krüger who reviews several legal authors (referencing them) and points out that they reject the right to secession and neither international treaties nor customary international law pertaining to state practice provide solid basis for such rights, excluding the cases of colonialism, situations of foreign occupation or where national law or national agreements allow secession. /11/ A very strong argument in this sense comes also from Theodore Christakis who suggests that even "in its legal dimension it is evident that self-determination does not subsume today, and probably will not subsume in the future, a general right of secession for the infra-state groups. On the contrary, what can be concluded from the experience of these last years is that the International Law is still hostile to secession, even in the colonial context unless the very exceptional theory of "remedy-secession" can be objectively applicable". /12/

UN monitoring bodies are also skeptical of the existence of the right to secession. In 1996 the UN Committee on the Elimination of Racial Discrimination in its General Comment XXI emphasized that: ".. [N] one of the Committee's actions shall be construed as authorizing or encouraging any action which would dismember or impair,

totally or in part, the territorial integrity or political unity of sovereign and independent States... In the view of the Committee, international law has not recognized a general right of peoples unilaterally to declare secession from a State". /13/

In the European context the right to self-determination was arguably narrowed down to its internal aspects as early as in 1975 with the adoption of the Helsinki Final Act by the Conference for Security and Cooperation in Europe (today the Organization for Security and Cooperation in Europe or OSCE). The Act provides that: "The participating States will respect the equal rights of peoples and their right to self-determination, acting at all times in conformity with the purposes and principles of the Charter of the United Nations and with the relevant norms of international law, including those relating to territorial integrity of States. By virtue of the principle of equal rights and self-determination of peoples, all peoples always have the right, in full freedom, to determine, when and as they wish, their internal and external political status, without external interference, and to pursue as they wish their political, economic, social and cultural development. The participating States reaffirm the universal significance of respect for and effective exercise of equal rights and self-determination of peoples for the development of friendly relations among themselves as among all States; they also recall the importance of the elimination of any form of violation of this principle". /14/ As it can be seen from the wording of this provision, European states agree that "peoples" can exercise their right to self-determination without going outside the norms of international law on territorial integrity of the states.

It is then important to take a look at the case of Catalonia and see how the right to self-determination applies there, especially on the background of recent events.

### **Case of Catalonia**

The history of unification of Catalonia with Spain goes back to the XV century when Ferdinand II of Aragon married Isabella I of Castile. However, even after several centuries, Catalonia persistently maintained a distinct linguistic, cultural, geographic and other features. Catalonia is one of the Spain's most economically developed regions, that hosts second largest city - Barcelona. Catalan independence movement activated in the beginning of XX century on the rise of leftist and nationalist movements. This movement has been suppressed during and after the Spanish Civil War. After the war, General Francisco Franco has implemented policy of marginalization and persecution of Catalans, revoking the Catalan autonomy and suppressing the use of Catalan language. After Franco's death however, the autonomy of Catalonia (with no right to secession) was restored by the new Spanish constitution in 1978. Self-governed by *Generalitat* several decades have passed without rise in the independence movements in Catalonia. /15/

While it is true that 1978 Spanish constitution provided for the special legal privileges to autonomous communities of Spain, it is usually pointed out that if taken specifically for Catalonia, these provisions do not have direct legal consequences as the constitution does not separate the autonomies from each other in categories. Thus, simply allowing Catalonia high levels of decision-making power. /16/ The powers of Catalan autonomy have been enlarged in 2006 and the "Draft of New Statute of Autonomy for Catalonia of 2005" remarkably called Catalonia a "nation". This draft was adopted as Statute of Autonomy that have seriously extended powers of *Generalitat* and was approved not without a controversy. Despite that fact, the accountability of Spanish autonomies to central government remained intact, while the constitutional guarantee of autonomy and municipal political jurisdiction have persisted as well. /17/

The year 2006 has notably marked a point that signified the mobilization of the supporters of the ideas of self-determination. While Catalan Statute of Autonomy was a huge step towards constitutional reform, with its ratification by both Spanish and Catalan parliaments and further ratification by the compulsory referendum held in Catalonia in the same year, the optimism of supporters has been somewhat brief and dissipated with the Spanish Constitutional Court ruling in 2010. The aforementioned attempt of Catalonia to secure greater devolution basically hit a wall, when Constitutional Court ruled that some fourteen articles of the Statute were directly unconstitutional, some others required reinterpretation and that the provision about Catalonia being a "nation" is without any legal grounds. The perception of this ruling in Catalonia was obviously negative and it was argued that the ruling in question may even be illegitimate as only ten out of twelve members of the Constitutional Court have voted, with one member have passing away with no replacement and the other being under challenges of his authority. Moreover, by the time of voting the terms of three other members have effectively expired. / 18/

The frustration with the aforementioned decision has pushed the political momentum even further. This drive, inspired by the Scottish referendum initiative in 2014, started the similar processes in Catalonia. In January 2014 Catalan parliament formally asked the Spanish parliament to transfer the legal power to hold referendum on independence to Catalonia. After Spanish parliament voted against this initiative, the Catalan parliament in September 2014 passed the law that would serve as legal basis for the referendum vote and allowed for "non-binding popular consultations". With that in place, Catalonia has called such a consultation on November 9, 2014. After the voting that was carried out by the volunteers, Catalan authorities have described its results as justification for the possibility to hold an official referendum, while Spanish government did not in any way recognize the voting and questioned its legality with regard to the constitution, simultaneously attempting the prosecution of some of the Catalan officials. /19/

Ultimately, the 2014 "consultations" have played a decisive role in the strive of the supporters of external self-determination in Catalonia. Their increasing role in the local politics and what was considered victories in 2014-2015 political process in Spain, led to the referendum and unilateral declaration of independence by Catalonia as described in the introduction to this paper. However, there are many questions on the possibility of Catalans to exercise their right to self-determination externally and demand secession from Spain under international law. First of these questions is of course are Catalans "people" in the meaning of the UN international treaties to demand external self-determination under international law? While Catalans have a lot of common features in terms of language, culture, history, geography, that make them separate from Spain, according to the article 2 of Spanish constitution they still remain a part of Spanish people. It is also true, that international law currently does not have a unilateral position on who the term "people" actually refers too. With that said, the absolute majority trend in legal literature and State practice first, points to the limitation of external self-determination by the principle of territorial integrity and, second, accepts that "people" as a term used in the UN documents refers exclusively to the colonial people or the entire population of the given state with no regard to other parts of the population. At the same time it is known that such groups of people as Catalans can exercise the internal right to self-determination within the boundaries of their state. With that in mind, while the given state is willing and able to provide such groups of people (basically minorities) with fulfillment and respect for their rights to freely decide their political, cultural and social status and preserves their specific identity, the right for external self-determination that may lead to secession is non-applicable in essence. /20/ Moreover, if we would take the position of the Declaration of Friendly Relations that speaks about the modes of the exercise of the right to self-determination, /21/ it is quite clear that it was not aimed at positioning the right to self-determination against the existing states that respect the right to self-determination for all the groups of its people, that should be allowed to participate in the administration of the given state on equal basis. The document ties internal and external self-determination together, protecting the states that comply with internal self-determination from the dangers of secession. /22/ With the same logic applied to Catalonian case, it has to be pointed out, that while there is a general respect towards the minority rights of Catalans from Spain and its government, they can only benefit from internal right to self-determination and cannot hope to exercise the external right to self-determination /23/ and use UN international legal instruments as a legal basis. On the other hand, the final possible argument of Catalans that secession for them is the last resort measure would also seem unsubstantiated. Previous state practice reveals that when it comes to the choice between principle of territorial integrity and the right to self-determination, the territorial integrity wins. /24/ The EU and the UN adopted similar approaches, although initially



the UN has defended the right to self-determination to end colonialism in 1960-s. The secession as the last resort measure became important part of the discourse after the decision of the Supreme Court of Canada on the secession of Quebec and Advisory Opinion of International Court of Justice in the case of Kosovo. /25/ However, none of the crucial factors spelled out by the courts in both of these cases can be applied to Catalonia. Truly exceptional case requires at least systematic and widespread violations of basic human rights of the minority on the unprecedented levels. In Catalonia, the rights violation by the state could have only been argued during the intervention of the Spanish authorities into the process of the referendum held on October 1, 2017. However, the levels of rights violation were far from the threshold that can be found in international judicial and state practice. /26/

### **Other European Cases**

One example of the autonomous region in Europe that has carried the questions of self-determination as a heavy burden is South Tyrol. Today this autonomy is one of the examples of the resolution of the territorial conflict with the complication of self-determination issues. Geographically located between Italy and Austria, South Tyrol is presently part of the former. Under the Treaty of St. Germain of 1919, after the end of World War I, Austria have lost both Italian-speaking Trento as well as southern part of the Crownland of Tyrol to Italy. Much of the history of South Tyrol in the XX century afterwards was about securing the autonomy for its German-speaking majority and Ladin-speaking minority. Its population was able to survive the Fascist and Nazi attempts of assimilation during 1930-s and subsequent World War II. However, even after the war was over, despite South Tyrolean population requests to be returned to Austria, the Allies insisted on the autonomy of South Tyrol within Italy. De Gasperi-Gruber Agreement was concluded in 1946 that guaranteed the equal rights for German-speaking and Italian-speaking populations, provided safeguards for the preservation of ethnical character, cultural and economic development of German-speaking group, educational rights, autonomous legislative and executive powers and provided other relevant rights and guarantees. To give this agreement a true international character, it was annexed to the 1947 Italian Peace Treaty. Austria, as a signatory and the South Tyrolean kin-state, was given a role of a "protective power". /27/

The South Tyrolean autonomy went through a tough journey of development from the implementation of De Gasperi-Gruber agreement to 1948 Autonomy Statute (that provided for limited power sharing with German-speaking population and failed to give equal standing for German language on par with Italian), to crisis in South Tyrol in 1950-s, to the Austrian peaceful intervention and even referral of the case to the UN. Under the pressure from the UN, Austria and Italy have been finally able to come up

with the solution in 1972 and adopt a new Autonomy Statute. It was later amended and then revised in 2001. Presently South Tyrol boasts an intricate system of being a Region split into two Provinces with a very specific administrative regulation that allows for the needs of all the minorities present there to be addressed. It has its own Parliament, Government, President, and hosts a wide range of legislative and executive powers. In 2001, South Tyrol received international guarantees of the nature of its autonomy, liberation of provincial legislation and increased powers and also specific measures in favor of the smallest minority - Ladin-speakers. /28/ Even more interesting is an example of autonomy in Aland Islands. Historically, the Aland Islands have been considered of strategic importance for a very long time due to their geographic location in the Baltic Sea region and their role in the European great power politics. Three different periods of modern history are attributed to Aland Islands to mark their natural importance. First, is a Swedish rule over the islands stretching from 1157 and to 1809, then Russian rule between 1809 and 1917 and finally the Finland's sovereignty over the Aland Islands from 1917 and up to the present time. /29/ When World War I was finally coming to an end the tensions around Aland Islands stirred once again. Aland Islands belonging to Russian Empire have been considered a part of Finland as they were included into the empire together in the early XIX century. Finland gaining its independence in 1917 raised the issue of Aland Islands on the background of turmoil in Russia and with European powers engaged in World War I. Finland considered the islands its sovereign territory, while islanders had a different view. In 1917 seven thousand people of the population of Aland Islands have signed a petition to reunite with Sweden. Their desire have been actively supported by Sweden, that was concerned for the population there and also for the strategic value of Aland Islands. In 1918 the Finnish side invaded the islands, prompting the Swedish troops to make a landing there under the pretext of "humanitarian mission". Swedish troops were forced to leave after the German occupation of the islands in March of 1918, that have ended with the defeat of Germany in World War I. /30/ The Finnish-Swedish tensions were rising due to the clear desire of Sweden to assist the Aland Islands in their bid for independence and self-determination and subsequent reunification with Sweden. /31/ On the other hand the civil war in Finland as well as a general turmoil and uncertainty of the post-World War situation did not play into the confidence of Aland Islands population in Finland and in its self-security. The fears were based on the domination of Finnish culture and language as opposed to the islanders being Swedish, both linguistically and culturally, and firmly oriented towards Sweden economically. Moreover, the population of the islands feared that Finland may end up socialist or communist in the political sphere. /32/ To the Paris Peace Conference of 1919 Sweden and Finland have arrived already engaged in the full-grown territorial conflict. However, during the course of the Paris Peace Conference different positions of European centers of power and Finland and Sweden, led to the

situation where the conflict was not resolved during the Conference itself. Instead the matter was referred to the newly created League of Nations on the proposal from Britain as "the only course for the Alanders". /33/ The conclusions of the Commission of Jurists and the Commission of Rapporteurs created by the League of Nations to solve the matter, have ultimately become the basis for the resolution of the Aland Islands question. Finland and Sweden have agreed on the conditions of the settlement before the final decision of the Council of the League of Nations that has enshrined the principles of the Aland Islands settlement on 24 June 1921. Three days later Finland and Sweden confirmed their formal agreement with the settlement. /34/

Aland Islands have been left within the territorial integrity of Finland despite the raised issues of self-determination both by the islanders themselves as well as by Sweden. In exchange Aland Islands received guarantees of highest level of autonomy. Finland have followed up on its obligations and even allowed for the autonomy to be extended twice: in 1951 and in 1991. The current status of the autonomy of Aland Islands is defined by the Autonomy Act of 1991, but another project for expansion is already underway. Aland Islands' system of self-governance has interesting features that includes solid and strong institutions native to the islands and combined bodies that provide links of this system to the state of Finland. Prominent features include delimitation of powers and checks and balances regime with regard to the Finnish state institutions. Thus, working in parallel, the Legislative Assembly of Aland Islands and Parliament of Finland can adopt legislation in the specified areas of jurisdiction. The same logic is applied to the executive bodies of Government of Aland Islands and Government of Finland, each playing their own role in administration. At the same time, the boundaries of roles of Governor of Aland, Aland Delegation and the President of Finland are specified in less detail. Due to the centralized nature of Finnish judiciary, the knowledge of the laws of Aland Islands required of all courts in the country, while Aland Islands feature their own specific administrative court. /35/

As it can be seen from above, Catalonia is not the only example of the autonomous solution for the regional ambitions to self-determination. However, in cases of South Tyrol and Aland Islands bids for independence have not been heard of for a very long time, and both autonomies are considered a success stories of internal self-determination. These cases only confirm that the current approach of contemporary international law to issues of self-determination, that was discussed above, is not theoretical and ultimately grounded in reality of state practice. The same internal self-determination can be implemented in case of Catalonia, provided that the approach from both Catalans and Spanish government would be in line with requirements of international law.

## **Impact of the Unilateral Declaration of Independence of Catalonia on the Future of Europe**

When Catalonia have made a unilateral declaration of independence, it produced an effect. It effectively created a political situation that impacted not only Spain as a state, but Europe as a whole and specifically EU as a political body with legal institutions. Before answering the question of what this declaration means for the future of Europe in terms of international legal regulation, it seems appropriate to identify what that declaration means for the international law. The unilateral declarations of independence are not new. However, the treatment of these declarations is still different from case to case, as shown by the state practice and international jurisprudence. Such declaration of Kosovo in 2008 is a very obvious example. While international Court of Justice concluded in 2010 that unilateral declaration of independence of Kosovo was not in breach of general international law or, for that matter, of the Resolution 1244 (1999) of the UN Security Council, it is widely considered to be a *sui generis* case. On the contrast, completely different case happened in Ukraine in 2014 with the unilateral declaration of independence of Crimea. Ukrainian peninsula basically seceded, when Russian troops have invaded most of its main city's administrative buildings. Under their careful watch the referendum took place (that was not conducted even with the minimum European requirements for election processes) to basically legitimize the Russian authorities' decision to annex Crimea. The results of the referendum as well as the unilateral declaration of independence were not recognized by the international community. Although, Russian Federation has tried to argue that the case was analogous to Kosovo. /36/ Hence, differences in situation lead to the differences in the treatment from the international community and produce a different state practice. In the case of Kosovo the International Court of Justice made a very particular distinction that seemingly guides the state practice afterwards. In the view of the ICJ, while unilateral declarations of independence do not fall under the protection of international law, they are not opposed to it either. Moreover, the unilateral declaration of independence is only considered not to be in violation of international law, when it is made in the democratic pronouncement, in the peaceful, non-violent context that excludes the use of force or violence. /37/ While self-determination claim of Catalonia as a basis of secession is very weak (to say the least), it can still be argued that because Catalonia proclaimed independence without violence or use of force and, arguably, in a democratic context, it can at least claim that the proclamation was not in opposition to the international law. But even so, the proclamation of independence *per se* is not sufficient for the secession to be recognizable. The new entity has to prove that it is not under the authority of any other state and that its independence from the original state is not under question. Thus effective and stable control of the territory (and population of that territory) by the government is required. /38/ The authorities of Catalonia were not able to demonstrate

that, of course. Moreover, even if the Catalan unilateral declaration of independence was not in breach of international law, it was obviously in breach of national laws of Spain that is a member of EU. With that, even more questions arise in regard to the contradictions with EU laws. For example, the article 4.2 of TEU declares that the Union should respect the essential functions of the member-states, one of which is to guarantee their territorial integrity. While the matters of secession are not explicitly regulated by the EU laws, the basic legal principles that lie in the foundation of the Union suggest that its regulation is strongly oriented towards preservation and integration of its member-states. With that in mind, it is hard to understand what hopes the Catalan secessionists had when they unilaterally declared Catalonia independent. From a political point of view, European Commission has always viewed Catalan secessionism as an internal issue of Spain. /39/ Generally the internationalist approach of EU to the fundamental issues predefines its wariness of separatism and awareness of possible repetitions should Catalonia succeed in secession from Spain. So for EU the recognition of the independence of Catalonia would inevitably mean the confrontation with other aspirants to the independence in Europe. That kind of scenario would be very negative for the European Union, already very vulnerable as it is in the present time. Ultimately, the setback for Europe would mean a setback for the processes of global governance. /40/ In that situation, the reaction of EU was very predictable and consequently Catalan politicians were left without any kind of support. Nonetheless, the impact of the Catalan declaration on Europe will be felt in the longer run as well. If before it was understood that the independence referendums in Europe would be rare events, now their likelihood will be decreased even more. At the same time, the Scottish referendum confirmed the possibility of conducting such votes to further the claims of self-determination. /41/ It is generally understood that self-determination referendums can put a considerable amounts of pressure on the state to reassess its policies towards minorities and their rights and maybe even reduce the levels on nationalism in them. /42/ Catalan bid failed even that. Instead, its unilateral declaration of independence was a last resort measure in the political game already lost and that situation is very clear now for the Europe as a whole. Despite that fact, putting all the blame only on one side would not be fair to say the least. While Spanish state was in its own right when it denied the external self-determination to which Catalans had no rightful claim, it had also failed to take their internal self-determination (minority rights) into consideration. Understanding the realities of the EU (the ones stated above) very clearly, Spanish authorities were able and choose to talk to their own minority from the position of power and ultimatums. Instead of engaging into the dialogue on the concerns and grievances of Catalans and their autonomy (starting at least a decade prior to the referendum), Spanish government pushed the conflict to the bitter end in order to demolish the self-determination aspirations with power. All of that, when there are such great examples

in Europe as South Tyrol and Aland Islands. What Catalonian and Spanish governments failed to achieve together is an appropriate mechanisms of communication and interaction between the region and the central government. Both success stories in South Tyrol and especially in the Aland Islands are there in large part due to the establishment and use of such mechanisms by their respective authorities. A very clear and apparent example are the institutes of Governor and Delegation that are functioning in the autonomy of Aland Islands since the beginning of XX century. Formally, the Governor of Aland is a representative of the Finnish state in the Aland Islands. He opens the sessions of local parliament (Legislative Assembly) instead of the head of the Finnish state and chairs another important institution - the Aland Delegation. Despite that fact, the role of the Governor is not to "govern" the autonomy. As a representative of the state, the Governor is responsible for deliverance of the proposals and statements of the Finnish state and its head to the local parliament. The appointment of the Governor can be done only with the consent of the local parliament in the Aland Islands and it is usually a person trusted in the islands. Thus, the Governor serves more as the liaison rather than the administrator. The Aland Delegation plays even more important role in the relations between autonomy in Aland Islands and the Finnish state. All the laws adopted by the Legislative Assembly are first examined by the Aland Delegation (a joint body of experts consisting from the representatives of both sides) on the compatibility with Finnish legislation. The Aland Delegation is using a judicial discretion (not political) in its opinions. If conflicts of competence arise, the Aland Delegation is frequently asked for opinion which it delivers and settles such conflicts. /43/ The establishment of similar mechanisms in the successful autonomous settings were simultaneously a prerequisite and the result of a perpetual dialogue of the state with its minority. The success of such dialogue is seen on the example of Aland Islands that have developed its autonomy in cooperation with Finnish state throughout the course of almost a century without any need to demand external self-determination. Unfortunately, the same cannot be said in case of Spain and Catalonia. The result of this situation is evidently a very bad example that a different, less democratic and less human rights oriented path is available in the European context when dealing with the returning issue of self-determination. This negative impact of the case of Catalonia will most likely be felt in the future.

### **Conclusion**

The way in which Europe is developing in the past decades is strangely challenged by the territorial politics that for some reason promotes independence for small groups of people. The European integration itself served as a driving force of cross-border mobility, where trans-national level became a new home for policy responsibilities. This situation was the reason for degradation of such notions as nation-state in form of the

only bearer of political authority and societal integration. /44/ In such a setting, the return of the issue of self-determination on the shoulders of minority nationalism is even more surprising and upsetting.

For Catalonia even prior considerations on the economic feasibility of its independence were inconclusive to say the least. More so, if we would take into the account the possibility of failing to rejoin the EU after its theoretical independence. The substantial damage to the economy of Spain would be inevitable as well. /45/ Thus, the economic considerations were not truly at the heart of the case of Catalonia.

On the other hand, the external self-determination as a claim is not justified for Catalonia either. The current standing of the international law does not cover all the implications of the right that derives from the principle of self-determination. However, it is only in the certain specific situations that international law may "green light" a secession. The right to secession does not exist in the international law and no special circumstances can be found in the case of Catalonia. What is also clear is that this Spanish autonomy and its population are entitled to the internal self-determination as a right. Thus, the referendum and the subsequent unilateral declaration of independence of Catalonia cannot be considered as justified under the international law. Having said that, it is imperative to mention that Spanish state has its share of responsibility to bear as well. Since 2000-s its approach to the internal self-determination of Catalans was not oriented towards the dialogue and minority rights protection. It was rather to exercise its central power to suppress the autonomous aspirations of Catalans and to stick with government's centralized policies. Thus, the Spanish state have effectively blocked possibilities for the development of the autonomy in Catalonia and that led to the minority nationalism and the independence movement. Both sides have failed to establish normal dialogue between regional and central authorities in order to address each other's concerns in terms of political, economic, fiscal, cultural, national and other policies and use good practices of other European countries. Catalonia and Spain were not able to establish and use legal mechanisms to settle the basic disputes effectively and on the daily basis of functioning relations between the state and the region (like for example in Aland Islands) and that was one of the main problems that opened the possibility for the political confrontation to reach the levels it eventually did. What Spain and Catalonia were able to achieve, at the end of the day, is a very unfortunate blow to the minority rights implementation in Europe. The case of Catalonia has proven to be a negative example of minority rights treatment as the EU reaction to the situation was ultimately on the side of Spanish authorities. While such position seems justified from the perspective of the political stability and sustainability of the European Union, the balance between the state sovereignty and minority rights protection was unfairly tilted towards the former. The created disbalance will inevitably negatively affect the future of Europe.

## References

1. Dr. Kamal Makili-Aliyev, researcher at the Faculty of Law, Lund University and at the Raoul Wallenberg Institute for Human Rights and Humanitarian Law.
2. Charles Scaliger, 'Catalonian Independence & the EU' *The New America* (18 December 2017), p. 19.
3. Lisa Abend, 'Crisis in Catalonia. The region runs up against the reality of a split from Spain' *TIME* (23 October 2017), p. 64.
4. For example, Hubert Ambruster, 'Selbstbestimmungsrecht' in K. Strupp and H. Schlochauer (eds), *Wörterbuch des Völkerrechts* (vol. 3 de Gruyter 1962), pp. 250-251; Daniel Thurer, 'Entwicklung, Inhalt und Träger des Selbstbestimmungsrechts' in E. Reiter (ed), *Grenzen des Selbstbestimmungsrechts* (Styria, 1996) pp. 34,37.
5. Legal Consequences for States of the Continued Presence of South Africa in Namibia (South West Africa) notwithstanding Security Council Resolution (Advisory Opinion) [1971] ICJ Rep 276, paras. 16, 31; Western Sahara (Advisory Opinion) [1975] ICJ Rep 12, paras. 12, 31.
6. Christian Tomuschat, 'Self-Determination in a Post-Colonial World' in Christian Tomuschat (ed), *Modern Law of Self-Determination* (Martinus Nijhoff 1993) p. 1.
7. Herman-Josef Blanke, Yasser Abdelrehim, 'Catalonia and the Right of Self-Determination from the Perspective of International Law', 18 *Max Planck Yearbook of United Nations Law* (Brill 2015), p. 545.
8. Dietrich Murswiek, "The issue of a Right of Secession - Reconsidered" in Christian Tomuschat (ed), *Modern Law of Self-Determination* (Martinus Nijhoff 1993) pp. 21-22.
9. UN General Assembly, Agenda for Peace (A/47/277, S/24111, 1992) <<http://www.un-documents.net/a47-277.htm>>, accessed 16 March 2019, para 17.
10. William Slomanson, 'Nagorno Karabakh: An Alternative Legal Approach To Its Quest For Legitimacy' (2012) 35 *Thomas Jefferson Law Review* 1, p. 41.
11. Heiko Krüger, 'Nagorno-Karabakh', in Christian Walter, Antje Von Ungern-Sternberg and Kavus Abushov (eds), *Self-Determination and Secession in International Law* (Oxford University Press 2014), p. 220.
12. Theodore Cristakis, *Le droit à l'autodetermination en dehors de situations de décolonisation* (Paris, La Documentation française 1999), p. 617.
13. CERD General Recommendation XXI (Right to Self-determination) (23 August 1996), para. 6.
14. 1975 Helsinki Final Act, 1, VIII,



15. <<http://www.osce.org/mc/39501?download=true>>, accessed 16 March 2019.
16. Scaliger (n 2), p. 20.
17. Eliseo Aja, 'Spain: Nation, Nationalities, and Regions', in John Loughlin and Eliseo Aja (eds), *Subnational Democracy in the European Union: Challenges and Opportunities* (Toronto, Oxford University Press 2004), pp. 229–253.
18. Alexander Beck, 'The Changing Face of Self-Determination: A Catalonian Case Study', *HEMISPHERES: Redefining Sovereignty & Legitimacy* (Vol. 36 Tufts University 2013), p. 56.
19. Robert Lineira and Daniel Cetra, 'The Independence Case in Comparative Perspective' 86 *The Political Quarterly* 2 (Oxford 2015), p. 263.
20. Alexander Gunn and Oliver Schmidtke, 'The Pursuit of Independence in Catalonia and Scotland: Towards a New Form of Civic Nationalism in Europe?' 9 *Review of European and Russian Affairs* 1 (University of Victoria 2015), pp. 6-9.
21. Blanke and Abdelrahim (n 7), pp. 547-549.
22. UN General Assembly, Declaration on principles of international law concerning Friendly Relations and Co operation among States in accordance with the Charter of the United Nations (1970, A/RES/25/2625) <<http://www.un-documents.net/a25r2625.htm>>, accessed 16 March 2019.
23. James Crawford, *The Creation of States in International Law* (2nd ed) (Clarendon Press 2006), p. 119; Christos Rozakis, 'Territorial Integrity and Political Independence' in Rudolf Bernhardt (ed), *Encyclopedia of Public International Law* (Vol. IV), p. 812.
24. Otto Kimminich, 'A "Federal" Right of Self-Determination?' in Christian Tomuschat (ed), *Modern Law of Self-Determination* (Martinus Nijhoff 1993), pp. 83, 92.
25. Murswiek (n 8), p. 36.
26. Blanke and Abdelrahim (n 7), pp. 552-559.
27. BBC Reality Check, 'Catalonia: Did voters face worst police violence ever seen in the EU?' *BBC News* (27 October 2017) <<http://www.bbc.com/news/world-europe-41677911>>, accessed 16 March 2019.
28. Antony Alcock, *The South Tyrol Autonomy: a short introduction* (County Londonderry, Bozen/Bolzano 2001) pp. 1-6.
29. Alcock (n 27), pp. 6-13.
30. James Barros, *The Aland Islands Question: Its Settlement by the League of the Nations* (New Haven and London, Yale University Press 1968), p. 1.
31. Pertti Joenniemi, 'The Åland Islands Issue', in Clive Archer and Pertti Joenniemi (eds), *The Nordic Peace* (Ashgate 2003), p. 88.
32. Barros (n 29), pp. 89-100.

33. Joenniemi (n 30).
34. Barros (n 29), p. 210.
35. Barros (n 29), p.65
36. Sarah Stephan, 'The Autonomy of Åland Islands', in Sia Spiliopoulou Åkermark (ed.), *The Åland Example and Its Components - Relevance for International Conflict Resolution* (Åland Islands Peace Institute, Mariehamn 2011), p. 33.
37. Joan Ridaó Martín, 'The Right to Secession in the Framework of Liberal Democracies and the Legitimacy of a Unilateral Declaration. The Case of Catalonia' (June 2015) *The Age of Human Rights Journal* 4, pp. 120-122.
38. Accordance with international law of the unilateral declaration of independence in respect of Kosovo (Advisory opinion) [2010] ICJ Rep 423, paras. 79, 81, 84.
39. Blanke and Abdelrahim (n 7), pp. 561-562.
40. Enric Ordeix and Xavier Ginesta, 'Political Engagement Principles as the Basis for New Regional Self-Determination Processes in Europe: The Case of Catalonia' (2014) *58 American Behavioral Scientist* 7, p. 932.
41. Scaliger (n 2), p. 22.
42. Lineira and Cetra (n 18), p. 262.
43. Andre Lecours, 'The Political Consequences of Independence Referenda in Liberal Democracies: Quebec, Scotland, and Catalonia' (April 2018) *50 Polity* 2, p.273.
44. Sten Palmgren, 'The Autonomy of the Åland Islands in the Constitutional Law of Finland', in Lauri Hannikainen and Frank Horn (eds), *Autonomy and Demilitarisation in International Law: The Åland Islands in a Changing Europe*, (Kluwer Law International 2007), pp. 89-92.
45. Gunn and Schmidtke (n 19), p. 3.
46. Beck, (n 17), pp. 61-62.

## THE GREAT EURASIAN BRIDGE ACROSS THE CASPIAN SEA

<sup>1</sup>Tamila Sh. Khalilova, <sup>2</sup>Elchin N. Khalilov, <sup>3</sup>Renying Li

<sup>1,2</sup>*International Academy of Science H&E, AS*  
<sup>3</sup>*Public Diplomacy Institute of Shanghai Cooperation  
Organization of Shanghai University*  
*prof.khalilov@ias-as.org*  
*lry1982asbj@163.com*



**The Great Eurasian Bridge across the Caspian sea**

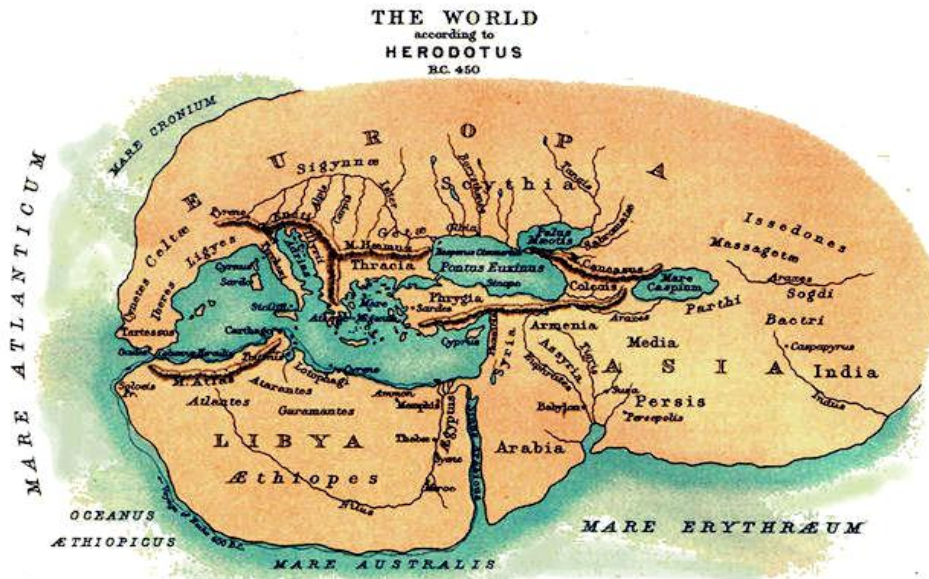
### **1. Historical aspects of the Caspian route of silk road**

Since the time of the Great Silk Road, Azerbaijan, which has a unique geographical position (in the center of the Europe-Caucasus-Asia transport corridor), has played a key role in world politics, connecting two continents. With the expansion of territorial expansion and the strengthening of trade relations between ancient states, the attention of kings, military leaders and scholars was turned to the Caspian region, as an important link in the global political and economic game.

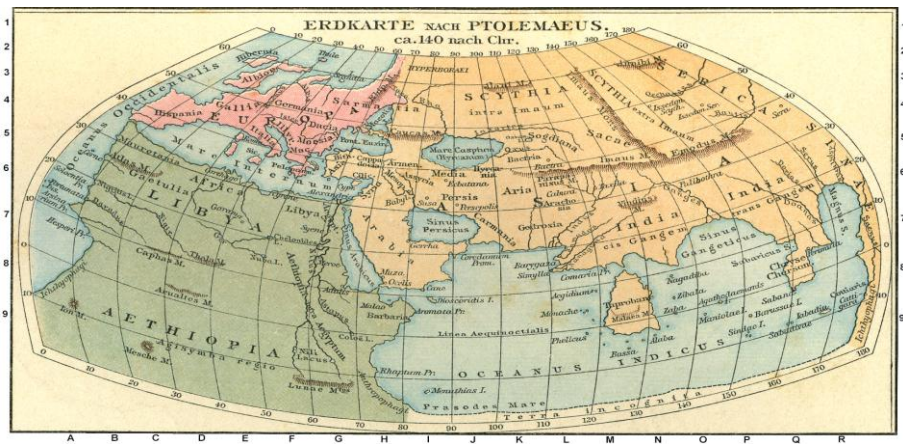
The routes from Central Asia to the West and back should either bend around the Caspian Sea from the north or south, or cross it. To answer these questions, it is necessary to consider the views of ancient authors on the Caspian Sea. Historians, archaeologists, geographers tried to determine the direction and time of the functioning of the relay, caravan routes, to understand the reason for their changes.

If we, when reading the works of ancient authors, consider geographical objects on the basis of their current state, we can get information that has no connection with antiquity. "A historian who does not take into account the changes that have occurred over the centuries in toponymy and, most importantly, in the geography of the country, will invariably fall into error, separating historical events from the present-day real situation" [11.p.130].

The descriptions of the Caspian Sea in historical, cartographic and ethnographic terms have retained its characteristics as one of the most controversial in world history. As R.Hennig noted: "The position of the Caspian Sea on the globe, throughout its entire antiquity, presented a riddle for geographical science" [21.t.1, ch., 26, p.244]. Having accumulated rich and complete information over its history, the Caspian remains as mysterious today. Initially, the Caspian Sea caused ambiguous and diametrically opposed opinions, starting with a discussion of its forms, size, nature of closure. A number of authors believed that it has a closed nature and is a lake, and, in contrast to the modern location, stretched in width. Others that it has a connection with the ocean. At the very first mention of the Caspian Sea (IX century BC) on the ancient clay tablets of Nineveh, the capital of Assyria, the Caspian Sea is called the "great eastern sea" [7]. Ancient authors know this sea under different names, but mainly under two. HekateiMiletsky calls him Hyrcanic "after the name of a famous region on the southeast coast of the sea ... ." [4. with. 6], Herodotus (6. I.202–203) mentioned the Caspian Sea, after the tribe of the Caspians who lived in the south-west of the Caspian Sea. Strabo, using both names, often called the sea Caspian. Also, a number of ancient authors: Pliny (VI. 35–36), Arrian (VII.16.2), Ptolemy (V.8) called him, either Hyrcanian, or Caspian. At that time, others distinguished them as different seas: Aristotle (Meteor.II, 1.10), Quint Curtius Rufus (Prince VII, Ch. 3, 20, 21), Pliny (Prince VI.XXI.58), Vasily Great (Caesarea) [9. . p.759], Stephen of Byzantine [9. p.831]. A number of ancient authors claimed the closed nature of the Caspian Sea: Herodot [6.I.202]; Apollonius of Rhodes [9.p.281]; the phrase of Aristotle, "under the Caucasus, the lake, which the natives call the sea ..." (kn.1.g.13.§ 29) indicates the closeness of the Caspian Sea [9.p.175]. On the map of Herodotus (Fig. 1), the Caspian Sea is depicted as being closed, strongly elongated from west to east.



**Fig.1. World map compiled by Herodotus (484 g. BC. E. - About 425 g. BC. E.)**  
**Ptolemy on his map depicted the Caspian Sea as a closed oval, stretched from west to east**  
**[VII, 5.4 Ptolemy A brief description of the map of the inhabited Earth].**  
<https://www.google.com/search?q=карта+мира+геродота&rlz>



**Fig.2. Ptolemy World Map**  
[https://upload.wikimedia.org/wikipedia/commons/f/f0/Claudius\\_Ptolemy-\\_The\\_World.jpg](https://upload.wikimedia.org/wikipedia/commons/f/f0/Claudius_Ptolemy-_The_World.jpg)

At the same time, it is clearly seen that the Greater Caucasus Range limits the Caspian Sea from the northwest, approximately at the latitude of the Absheron

Peninsula. Ancient authors, whose works contain sufficiently detailed and valuable information about the Caspian Sea and the Caspian Ecumene, also mark the mountains in the north of the Caspian Sea. In particular, Strabo noted that: "The Caucasian ridge is surrounded from the north by two seas, the Caspian Sea and Pont, separating the Sarmatians and Meotians from the Iberians and Albanians; he is very rich in forest." [9. Strabo X1.1.c.402]. In one of the fragments, Pliny reported that: "... The Caspian Sea is all surrounded by the Caucasus Mountains" [12.kn.VI.X.28]. In another fragment, Pliny also notes the mountains around the entire coast of the Caspian Sea: the sea due to the mountains surrounding it" [12.VI. XV.40.].

In the north of the modern Caspian there are no mountains. "The Caucasus range surrounds from the north" - only the southern part of the modern Caspian. This is the Absheron threshold, which is currently under water.

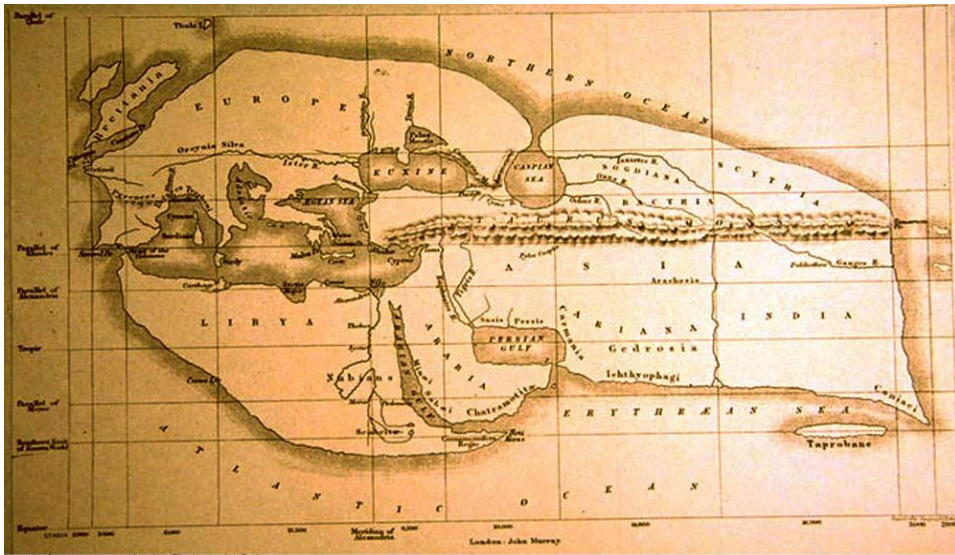
Descriptions of ancient authors indicate that the Apsheron threshold in antiquity was located in the north of the sea, as a continuation of the Caucasus, and in the south, respectively, it is closed by the Elborz mountain range (modern Iran).

Information about the Caspian as a closed basin, which had no connection with the ocean, continued to exist along with the opposite point of view, where the Caspian was asserted as a gulf open to the Northern Ocean.

The ancient mythical and cosmographic representations of the Greeks were based on the connection of the Hyrcan (Caspian) Sea with the ocean. Those. says about the connection of the channel or the strait with the North Sea (Ocean). The description of the Caspian as a bay open to the north is reflected in many of the cartographic schemes influenced by the reports of the navigation of Patroclus (circa 283-282 BC).

On the map of Eratosthenes, the Caspian Sea has a connection, through the strait, with the world Ocean, which is located quite close to it. It remained relevant, even after the II century AD. e., despite the work of Claudius Ptolemy, who presented the Caspian Sea not as a gulf, but as an isolated sea. At the same time, next to the Lake Meoti (Sea of Azov), Ptolemy calls the Sarmatian ocean to the east, where: "6. ..with Europe is connecting [Asia]." [Ptolemy Geographical Guide 6]. This is the basin of the Northern Caspian.

According to Pliny, the Caspian Sea also joins from the Ocean through the strait [Kn.VI.XV.38]. The phrase of Apollonius of Rhodes, who noted: "The Caspian Sea near the Ocean" [9. p.281]. Arrian, speaking of the Hyrcan Sea, in the first fragment [2. v.V.26.2] notes that it merges with the Indian (ocean or sea), in the second - it is the Gulf of the Great Sea [2. v.V.5.4].



**Fig.3. World map on Eratosthenes (c. 194 BC). Reconstruction of the XIX century.**

Strabo, reporting on the connection of the Hyrcan (Caspian) Sea with the Northern Ocean [19. XI, 6.1; 7.4] noted: “from the north they are washed by the ocean to the mouth of the Caspian Sea” [19. XI.1.5]. Dionysius Periget Egyptian in the II century AD notes its difficult terrain: “718. Here are his words: “With a sharp angle protruding to the north, it connects with the Ocean. [9. p.942.].

Pristian in his work "Land Description" (644 - 721) placed "**near the Sea of Saturn and the mouth of the Hirkan Pont**" [1.p.55]. On the Posidonian map Fig. 4, the Caspian Sea consists of two parts — the southern one, elongated in the latitudinal direction, and the northern one, elongated in the meridional direction, with a significant narrowing of the sea occurs in the form of a strait. Thus, the ancient authors, along with the Girkan (Caspian) Sea, are mentioned next to the water basin - the Ocean.

If the Hyrcan Sea lay in the basin of the Southern Caspian, in the north of which the overland Absheron threshold passed, the basin of the Middle and North Caspian could be perceived as the Ocean connected to the flowing river beds in the north. The ancient authors, speaking of the Caspian Sea, note the presence of two reservoirs: the Caspian and Hyrcan seas, connected by straits.



Fig.4. Map of Posidonius, about 150-130 BC.

“Aristotle spoke of two different basins: the Caspian Sea and the Hyrcan Sea. Ch. Iii. Aristol., Meteor. II, 1, 10) ” [9. p.175], Quit CurtiusRuf [8.cn.VII, ch. 3 .20.21]. The Caspian Sea, in this passage, is listed as separate from the Hyrcan Sea. Plutarch reports on the Caspian Sea as the Gulf of the Hirkan Sea, existing independently [13., Alexander, 44, 1].

In the IV th century AD Basil the Great (Caesarea) noted: “IV, 4 (M., XXIX, 88). However, some think that both the Hyrcan and Caspian seas **are enclosed in themselves**; but if only one should believe the descriptions of the narrators in any way, **they have mutual communication and all are connected with the greatest sea by narrow straits**” [9. Nine conversations on the Six Days. p.759].

The existence of two reservoirs: the Caspian and Hirkan seas separated by the Absheron threshold, which we call the Caspian-Hirkan isthmus, places a new emphasis on considering the history of the peoples of the Caspian region.

In Chinese sources describing the ancient Silk Road on the territory of the Caspian Sea, we find a mention of two seas: the Western Sea (Sikhai) and the North Sea (Beihai).

The messengers of the Chinese emperor, opening the Western Territory for the Celestial Empire, found an already existing trading water-land route connecting India



with the West. "Judging by a number of sources, the Great Indian Way arose much earlier than the Great Silk Road, and it was he who became the first transcontinental route in the history of civilization connecting East and West - the Mediterranean, the South Caucasus, Central Asia, India and China" [18. eleven].

The work of SimaQian "Shi Ji" presents the results of the diplomatic and intelligence activities of Zhang Qian under the emperor of the Han Wu Dynasty (141 to 87 BC). "To the west of Yutian, all the rivers flow to the west and flow into the Sihai (Western Sea)" [20., Ch. 123., 7.]. The state of Daiyuan ("Davan") occupied the territory in the Fergana Valley. If the state of Davan was located in Fergana, and Yutian (Khotan) was located from it in the east (to the west, from which all rivers flow to the west and flow into the Western Sea), then Sihai or the Western Sea is the Hyrcan Sea (South Caspian basin) celebrated by ancient authors. On the maps of Eratosthenes Fig. 1, Strabo Fig. 3, Ptolemy Fig. 2, rivers flow to the west and flow into the Hyrcan Sea (basin of the Southern Caspian).

Chinese ambassador Zhang Qian and other emissaries of the empire provided information about the country of Yancai in 2000 li north-west of Kantszyu (territory of Khorezm). "Yancai is often identified with aorses. According to custom, they are similar to Kantszyu, they can put out more than 100 thousand horse archers. They live by the sea with low shores - **Beihai (North Sea), probably the Caspian Sea**" [20].

More detailed than in Shi Ji, information about Kanpoi is contained in the "History of the Elder Dynasty of the Han", the Chinese historian Ban Gu in the middle of the 1st century. n er "In 2000, the state of Yancai, which has up to 100,000 troops, lies from Kaishoya to the north-west, and in its basic features it is completely similar to Kangyuy. **It is adjacent to a great lake with sloping shores. This is the north sea.**" [24., § 2.].

Hou Han Shu adds important information about Yancai: "356. In the XXIII a short (only 32 hieroglyph) reference is given about the state of Yancai, whose name has been changed to Alanlao" [22. Ch. 88, p. 17b, 2-5].

Thus, the succession of tribal and state formations can be traced: Yantsay, - aorses, - Alanlao (Alania), located in the historical period in the north-west of the Caspian Sea.

On the modern maps, between the ancient lands of the Kangyuy (Khorezm) and Alanlao (northwest part of the Caspian) states lies the Caspian Sea. The words "adjacent" and "border" suggest the existence of a land boundary.

This route: Kangyuy (Khorezm) - Yancai (Alanya) - Daqin (Rome), because "In the west, they (Yantsan) are demolished with Daqing" [23. Part I, Chapter 7, Supplement from Shofanbeicheng, ch. 31, p. 18b.], Becomes a convenient trade route from India and China to Europe. Being one of the routes of the Great Silk Road, it was controlled by aorses along the Caspian-Hyrkan isthmus, which is currently under water, along the

north-western coast of the Middle and North Caspian, and further to Meotida (Sea of Azov) or the Black Sea.

This section of the Silk Road was marked by Eratosthenes (c.276-194 BC), describing the distance from **Amis through Kolkhs and Hyrkania up to the Bactrias: "it goes in a straight line to the equinox east** (marked by the author) and along the mountains, remaining to the right of him" ? [ 16 p. 268]. According to the scheme obtained: Colchis - Hyrcania - Bactria, the direction of motion is recorded in a straight line to the east. Colchis - gyrcania - Bactria, the direction of motion is recorded in a straight line to the east. Colchis - on the Black Sea coast, Hyrcania was located in the southeast of the Hyrcan Sea, Bactria in Central Asia. However, connecting this line on the map, which "**goes in a straight line to the equinoctial east**", we will get the land Absheron threshold. No trajectory deviation is mentioned either north or south to circumvent the Caspian Sea. No mention of the sea route. Scientists, based on the modern structure of the Caspian Sea, come to the conclusion that this path is impossible. "**Many other reports of Alexander's historians probably also go back to Policlet** in which ideas about the **proximity of Bactrians, Sogdians and neighboring countries to Pontus, Meotida and Europe** (highlighted by the author) were reflected, **but it is impossible to accurately determine the origin of all these messages**" [17. p.36]. This route of Indian goods to Europe is reported by Strabo (II, 1.15; XI, 7, 3), referring to Patroclus, and CurtiusRuf (VI, 4, 19). Strabo, following Eratosthenes, notes: "Let us add that Oaks, which forms the border between Bactria and Sogdiana, is known as so convenient for navigation that goods from India, transported along this route, descend without difficulty until Hyrcania, where they are subsequently distributed by river to all neighboring countries up to Pont ". Here - the goods go down to Hyrcania, **where they are distributed from** (allocated by the author) by river. First of all; there is no description of the sea route: secondly; the river path from Hyrcania is mentioned.

Analyzing the fragment of Strabo (II.1.15) where it is noted that goods are delivered to Hyrkania, but in the translation of G.A. Stratanovsky it is emphasized "to the Sea of Hyrkan", and from there by rivers to Pont, I. Najafova **notes our previous thesis on the sea trade route** (highlighted by the author) " [10. p.82].

In this direction is the Absheron threshold connecting the western and eastern shores of the Caspian Sea and, at present, under water.

This isthmus was mentioned by ancient authors, speaking of the territory “behind” the Caspian Sea and “above” the Hyrcan Sea.

Strabo (Book II, Chapter V, 31) in his two fragments gives amazing messages, listing the tribes: “... and then, over the Sea of Hyrcanes, Scythians, gyrcanas, Parthians, Bactras, Sogdians ...” [9.p.361 ]. And in the next report we read the mention of the tribes "who lived beyond the Caspian Sea ... Massagettes" [19. XI.VI.2]. This is also evidenced by the extract from the works of MelaPomponius: “Behind the Caspian Gulf are areas: homar, massagets, kaduziyev, gyrcanas, Iberians”. [14. kn.1.gl. li. A brief description of Asia. p.12].

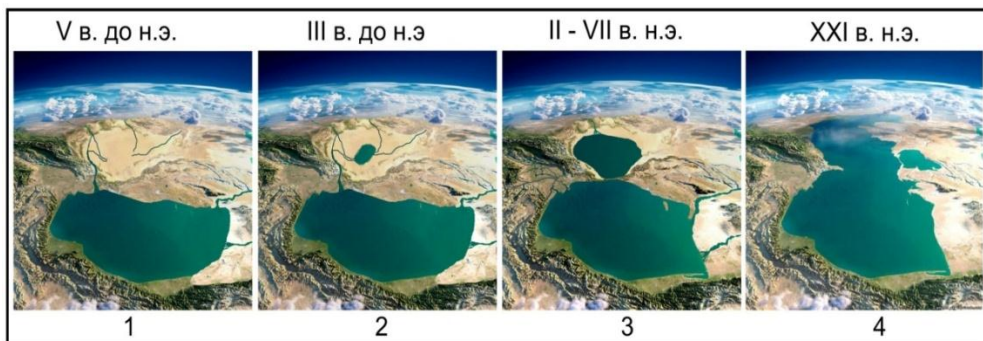


**Fig.5. Map of Strabo with the image of the Caspian Sea.**

Hence, there was a territory that was simultaneously across the Caspian Sea and over the Hyrcan Sea. We note the description of this path at Strabo: “to the mountain pass on the Hyrcan Sea, and after this [the way to Bactra will be revealed]” [19.II.1.3].

Here we also do not observe the fixation of sea voyage and, there is no change in the trajectory - the direction is only to the east. There is a memory of the isthmus in folk legends, reflected in written sources: “Many Eastern historians call the Caucasus Albures. KatibChelebi in Jahan-numa says that Al-Burs lies to the west of Bab al-Abwab, or Derbend, and is connected to a chain of mountains (highlighted by the author) stretching from Turkestan to Hejaz [3. p.13]. The mountains from Elbrus and Derband to Turkestan could only connect along the Absheron threshold. In his work I.V. Pyankov, “Central Asia in the Ancient Geographical Tradition: Source Study Analysis,” examining Skilak’s iterarii across the Caucasus, notes a clear common characteristic of all these mountains. “... The author of the chinérariya himself, Skilak, perceived them as a kind of unity: **the mountains surrounding the Hyrcan Sea apparently continued directly with the mountains of Khorasmii**” [17. p.194].

Bakikhanov A., an eminent Azerbaijani historian, philosopher, poet, in the work “Gulustan-iIram” devoted to the history of Azerbaijan and Dagestan noted: “**There is a legend between local residents that in ancient times there was an isthmus from Baku to Turkmen shores, through which equestrian Turkmen sent here ...**” [3. p.20-21].



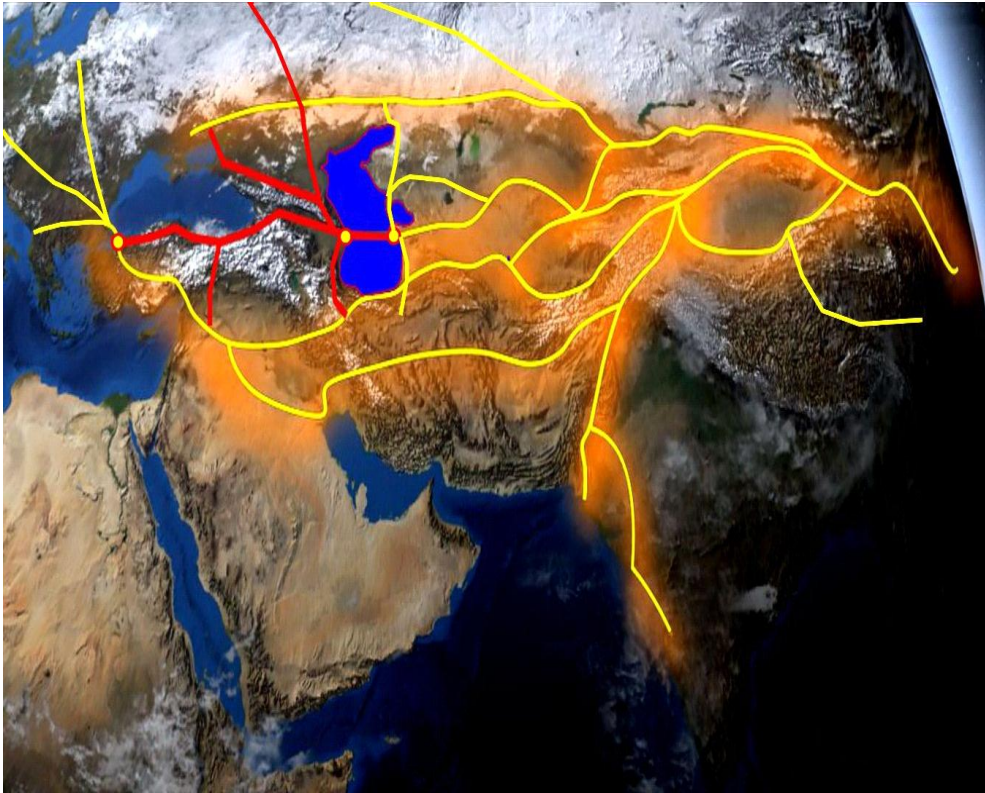
**Fig.6. Historical and geological reconstruction of the dynamics of the shape of the Caspian Sea. (Authors: E.N. Khalilov, T.Sh. Khalilova, 2017)**

**The mountain pass on the Hyrcan Sea** is the Absheron threshold, i.e. the so-called Caspian-Hyrceanic Isthmus. The trade route from India and China, Central Asia **through the Caspian Sea along the Apsheron threshold**, Caucasian Albania and further to Pont (Black Sea) or to the north to Europe were tied together by a bundle of land, river and sea routes of the Great Silk Road. And here, the “Caspian-Hircean Isthmus” history has played the role of a bridge between Europe and Asia, confirming the reality of the functioning of the “Strabo Road”.



**Fig.7. 3D Reconstruction of the possible appearance of the isthmus through the Caspian Sea in the II - VII centuries A.D. based on a satellite image.**

Historically recognized land routes are shown in yellow; Control over the most important trade routes of the Great Silk Road became the basis of rivalry between the great powers of that time - Rome, Parthia, Byzantium.



**Fig. 8. Land routes of the Great Silk Road.**

The result of the conquests and involvement in the global political, economic and industrial circulation of all countries of antiquity, was the creation of the first prototype of ancient globalism.

### **References**

1. Aliyev K.G. Ancient sources on the history of Azerbaijan. B. 1987.
2. Arrian Lucius Flavius. Per. Sergeenko M.E. M. Mif. 1993.
3. Bakikhanov A.K. Gulistan-iIram. Baku: Elm, 1991, 304 p.
4. V.V. Barthold "Information about the Aral Sea and the lower reaches of the Amudarya from ancient times to the XVII century." Cit., T. III. M., "Science", 1966.
5. Geybullaev G.A. To the ethnogenesis of Azerbaijanis, t. 1.b; Elm, 1991.
6. Herodotus. Herodotus Per. Mishchenko F.S. Edition A. G. Kuznetsov. Typography E. G. Potapova Moscow. 1888

7. History of the Caspian Sea. | [silkadv.com/silkadv.com/ru/node/88](http://silkadv.com/silkadv.com/ru/node/88)
8. Quint Curtius Ruf. The story of Alexander of Macedon. M. ; MSU Publishing, 1993
9. Latyshev V.V. Proceedings of the ancient Greek and Latin writers about Scythia and the Caucasus // Herald of ancient history. - 1947. - № № 1-4; 1948 - № № 1-4; 1949. - № № 1-4. Source:  
  
[http://apsnyteka.narod2.ru/l/izvestiya\\_drevnih\\_pisatelei\\_o\\_skifii\\_ikavkaze/index.html](http://apsnyteka.narod2.ru/l/izvestiya_drevnih_pisatelei_o_skifii_ikavkaze/index.html)
10. Najafova I. On the role of the Caspian Sea in international trade (according to Strabo). . (Proceedings of the international conference “Strabo Road as part of the Great Silk Road”. Baku, November 28-29, 2008). International Institute of Central Asian Studies, Samarkand - Tashkent, 2009
11. Novoseltsev A.P. The most ancient states on the territory of the USSR. Materials and research 1986. M. : Science, 1988
12. Line Senior. Natural History, IV, 26, 29. Translation by V. Latyshev. VDI, 1949, №2.
13. Plutarch. Comparative biographies: In 3t. Ed. prepared by M.E. Grabar-Pasek and S.P. Markish-M.: Publishing House of the Academy of Sciences of the USSR, 1963.
14. Pompony Mela. On the position of the Earth. Antique geography. M., 1953.
15. Ptolemy Claudius. Geographical guide. <http://coins.ucoz.ru>
16. Pyankov I.V. Central Asia and the Eurasian steppe in antiquity. S.-P., 2013.
17. Pyankov And V. Central Asia in the ancient geographical tradition M.1997
18. Rtveladze, B.V. The Great Indian Way: From the History of the Most Important Trade Roads of Eurasia. - SPb.: Nestor History, 2012. - 296 seconds
19. Strabon. Geography in 17 books M., publishing house Nauka.1964 ,: 1994 per. G.A. Stratanovsky under the general ed. prof. S.L. Utchenko
20. Syma Qian Historical notes. Eastern Literature [www.vostlit.info/Texts/Dokumenty/China/I/Syma\\_Tsjan](http://www.vostlit.info/Texts/Dokumenty/China/I/Syma_Tsjan)
21. Hennig Richard. Unknown land. v.1. M., 1961
22. Hou Han Shu. West end. - Alanica [www.alanica.ru/library/Houhanschi/Houhanschi.htm](http://www.alanica.ru/library/Houhanschi/Houhanschi.htm)
23. ENCYCLOPEDIA OF CHINA, Part I, Chapter 7 “Shofanbeicheng” He Chiu-Tao. Supplement, ch. 31, p. 18b [www.abirus.ru/content/564/623/626/14338/15081/15092.htm](http://www.abirus.ru/content/564/623/626/14338/15081/15092.htm)
24. ENCYCLOPEDIA OF CHINA - Ban HYPERLINK "<http://www.abirus.ru/content/564/623/626/12557/12563.html>"Гy HYPERLINK "<http://www.abirus.ru/content/564/623/626/12557/12563.html>" - Historical Figures of China ... [www.abirus.ru/content/564/623/626/12557/12563.htm](http://www.abirus.ru/content/564/623/626/12557/12563.htm)

## 2. Geological confirmation of the existence of the land isthmus through the Caspian sea

The Caspian Sea is located at the junction of Europe and Asia. The length of the sea from north to south is about 1200 kilometers ( $36^{\circ}34' - 47^{\circ}13'$  n. l.), from west to east - from 195 to 435 kilometers, on average of 310-320 kilometers ( $46^{\circ} - 56^{\circ}$  in e. l.). The Caspian Sea is conditionally divided into three components according to geographical conditions - the Northern Caspian (25% of the sea area), the Middle Caspian (36%), the Southern Caspian (39%) according to physic-geographical conditions [4, 19]. The conditional boundary between the Northern and Middle Caspian passes through the island of Chechen - Cape Tyub-Karagan, between the Middle and South Caspian - along the line of the island of Chilov - Cape Gan-Gulu. Currently, the area of the Caspian Sea is about 371,000 km<sup>2</sup>. The relief of the northern part of the Caspian Sea is a shallow undulating plain with banks and accumulative islands, the average depth of the North Caspian is 4-8 meters, the maximum depth does not exceed 25 meters. Mangyshlak threshold separates the Northern Caspian from the Middle one. The Middle Caspian is deep enough; the depth of water in the Derbent basin reaches 788 meters. Absheron threshold divides the Middle and South Caspian. The Southern Caspian is considered to be deep-water, the depth of the water in the South Caspian basin reaches 1,025 meters from the surface of the Caspian Sea. Shellfish sands are found on the Caspian shelf, the deep-water areas are covered with muddy sediments, in some areas there is a bedrock outlet.

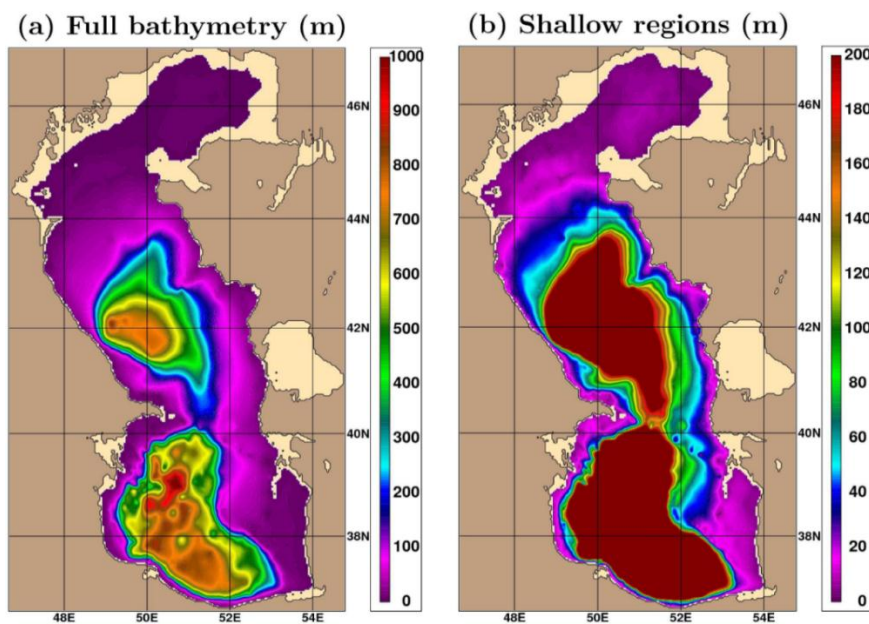
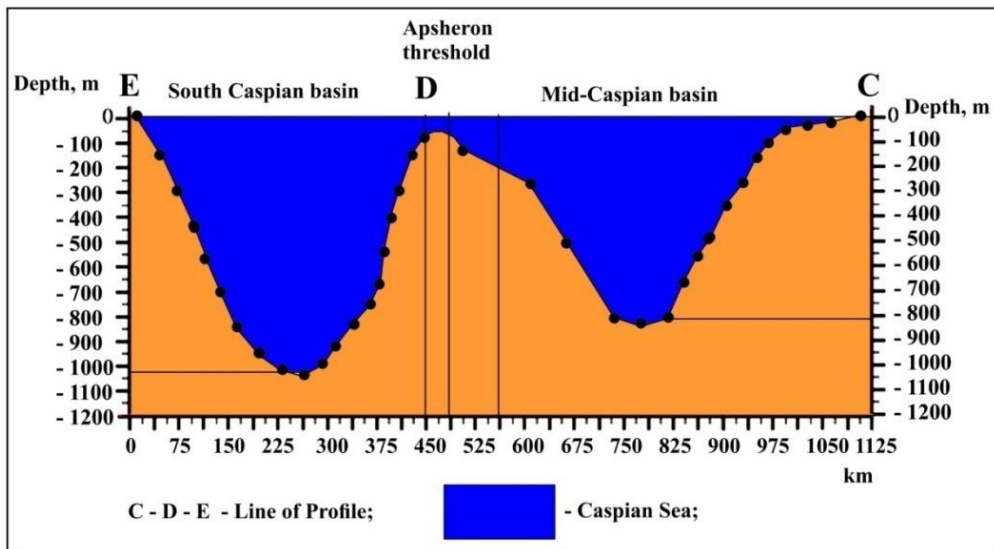


Fig.9. Bathymetric maps of the Caspian Sea [19].



Bathymetric researches carried out in the Caspian Sea made it possible to draw a sufficiently detailed bathymetric map reflecting the not quite usual relief of the Caspian basin. The unusual structure of the bottom of the Caspian Sea, first of all, is expressed in its division, as if into two independent basins, separated by the Absheron threshold, Fig.9. The relief of the bottom of the Caspian Sea indicates the possibility of existence an isthmus across the Caspian Sea in the historical past.

From geological and hydrological point of view, this was indeed possible.



**Fig.10. Bathymetric profile through the Caspian Sea along the E-D-C line.**

The Isthmus in the Caspian Sea could have been formed as a result of a decrease of the water level in the Caspian Sea in the II- VII centuries A.D. and in a geological aspect, reflected the so-called Absheron threshold [2.8], crossing the Caspian Sea from the Absheron peninsula till the shores of Turkmenistan, well reflected on the bathymetric profile - Fig.10 and shown on the 3D model, Fig.11

As it is seen, on the bathymetric profile A-B, laid along the Absheron threshold, its deepest part lies to the east of the island of Chilov (the earlier name is Zhiloy). Here, the maximum depth of the sea reaches 160-170 meters, while on both sides of the Absheron threshold there are deep-sea basins, Fig.12.

Described in detail in the previous section and reflected in historical sources, the sharp decline of sea level and appearing of a narrow isthmus of land, and subsequently

its rapid submersion under water in the VIII century A.D., can only be explained with tectonic processes-the deformation of the sea floor [15].

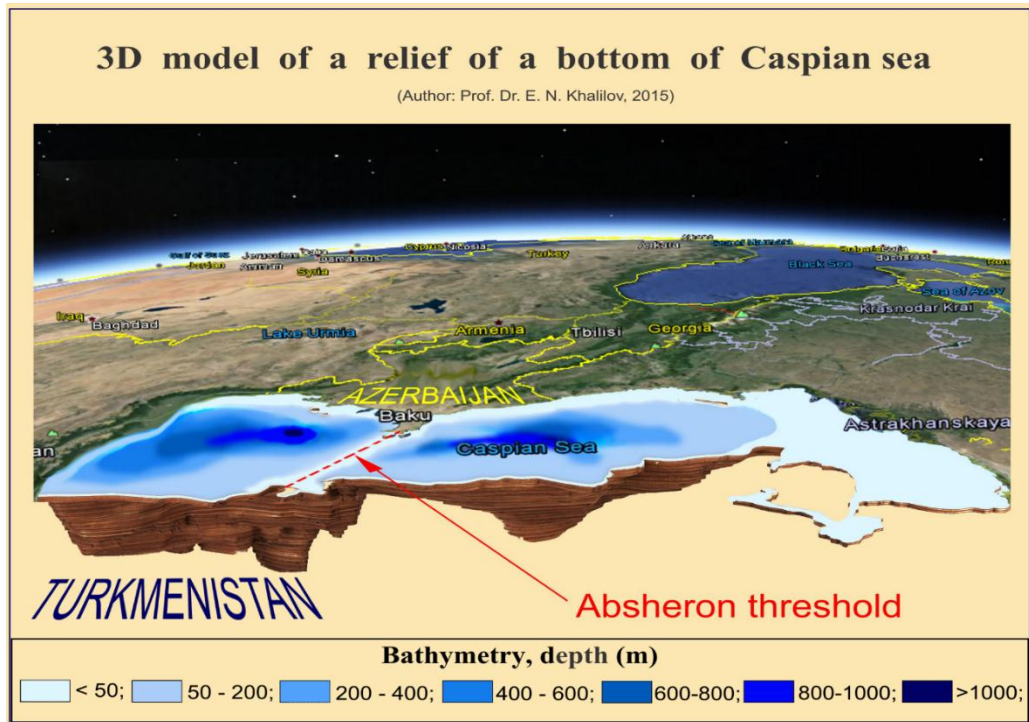
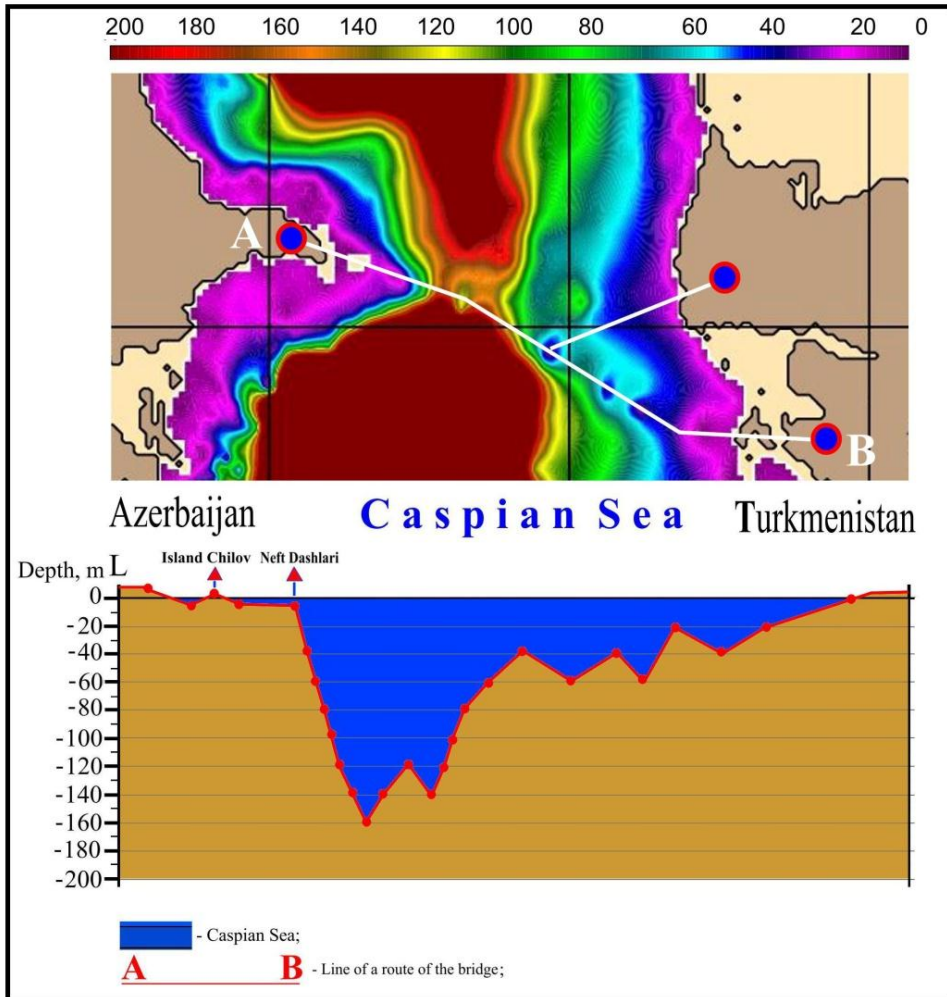


Fig. 11. 3D image of the bathymetry of the Caspian in a section. (E.N. Khalilov, 2015).

Fig. 12 shows a fragment of the bathymetric map in the zone of Absheron threshold and a bathymetric profile along the A-B line passing along the threshold. The fragment clearly shows that the sea area with a depth of 160 m is very narrow, about 5-6 km long. As it was already mentioned, the Middle Caspian and the South Caspian basin are two deep trenches, between which there is a rather narrow uplift - the Absheron threshold. From the point of view of tectonics, the Absheron threshold is a geological continuation of the Great Caucasus ridge under the waters of the Caspian Fig. 13, which was once a land and in the west this range is connected with the Kopetdag mountain range [11-13]. This is evidenced by the geological data and the results of modern geophysical studies, as well as the discovery here of the Vadati-Zavaritsky-Benyof seismic focal plane, which allows us to accurately establish an ultra-deep fault, according to which the relic of the oceanic microplate slowly continues its plunge under the Eurasian plate in the North-West direction, Fig.14. [9, 10, 16]. In general, these

mountain ranges represent a segment of the Alpine-Himalayan folded belt, the territory of which is a relic of the ancient Tethys ocean, which existed here 150-200 million years ago.



**Fig.12. Fragment of the Bathymetric map in the zone of Absheron threshold and a bathymetric profile along the A-B line.**

At the boundary of lithospheric plates there occur active tectonic processes, leading to constant vertical and horizontal movements of tectonic blocks of the earth's crust. As a result of these movements, the relief of the Caspian Sea and adjacent territories changes its shape, and this leads to the flow of water from one territory to another without significant changes of the volume of water. The significant influence of tectonic movements on the dynamics of the shape and size of the Caspian Sea area is also indicated in the works of other researchers [2].



Fig.13. Map of the Caucasus-Kopetdag region, on which the red line shows the axis of the mountain ranges, which represent one of the fragments of the Alpine-Himalayan folded belt.

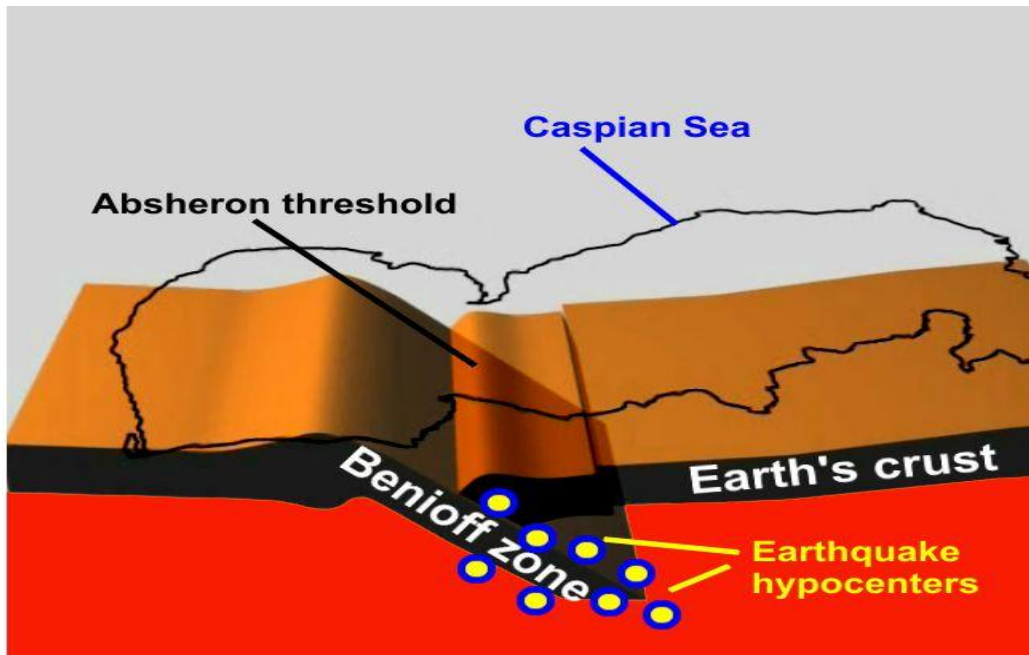
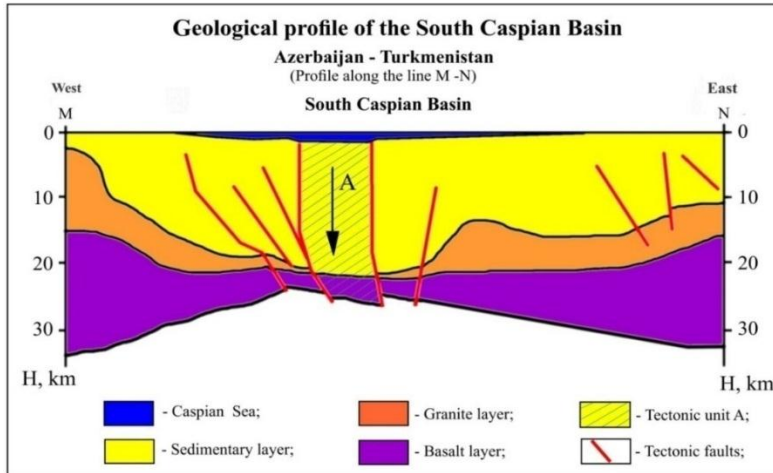
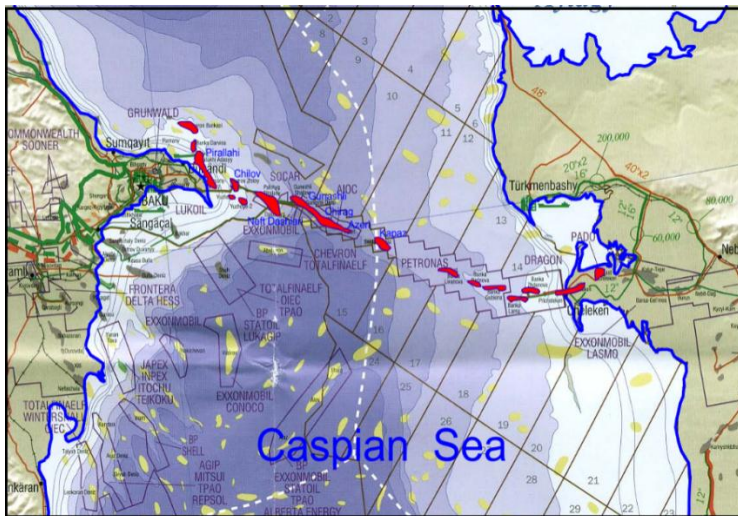


Fig.14. The Vadati-Zavaritsky-Benyof zone on the Caspian Sea.  
(drawn by E.N. Khalilov, 2002)

Confirmation of the confinement of the South Caspian basin to the ancient ocean Tethys is the oceanic structure of the Earth's crust of the South Caspian basin Fig. 15, in the deep-water part of which there is no granite layer, which is characteristic only for the earth's crust of oceanic type. In the Middle Caspian, the granite layer appears abruptly with sufficiently large power, which indicates the confinement of the Middle Caspian to the earth's crust of continental type [12].

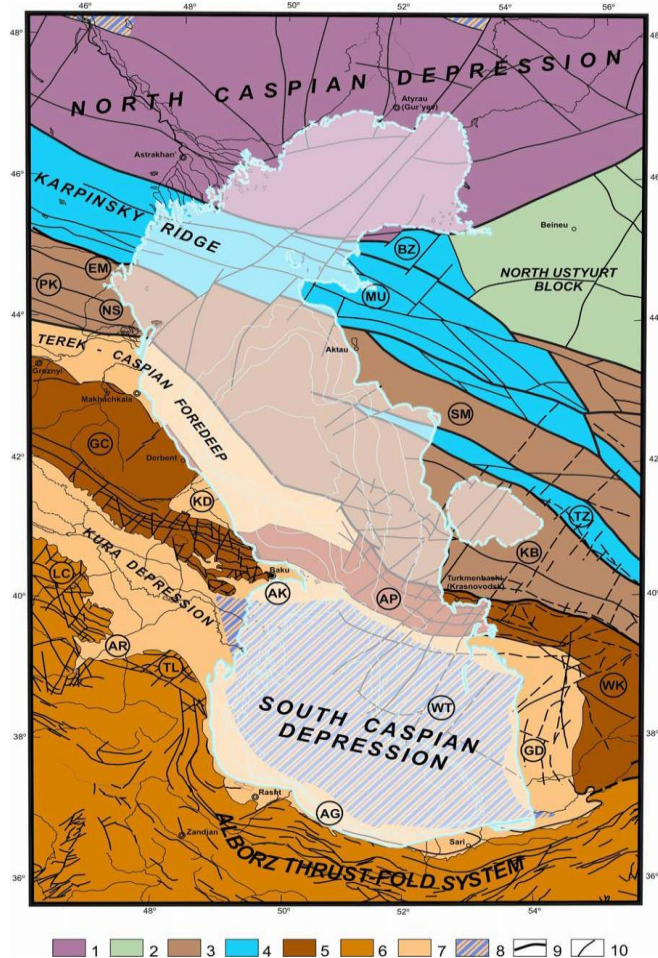


**Fig.15. Geological section of the South Caspian basin along the MN line from west to east (drawn by E.N. Khalilov, 1998)**



**Fig.16. Map of oil and gas bearing structures of the Absheron threshold.**

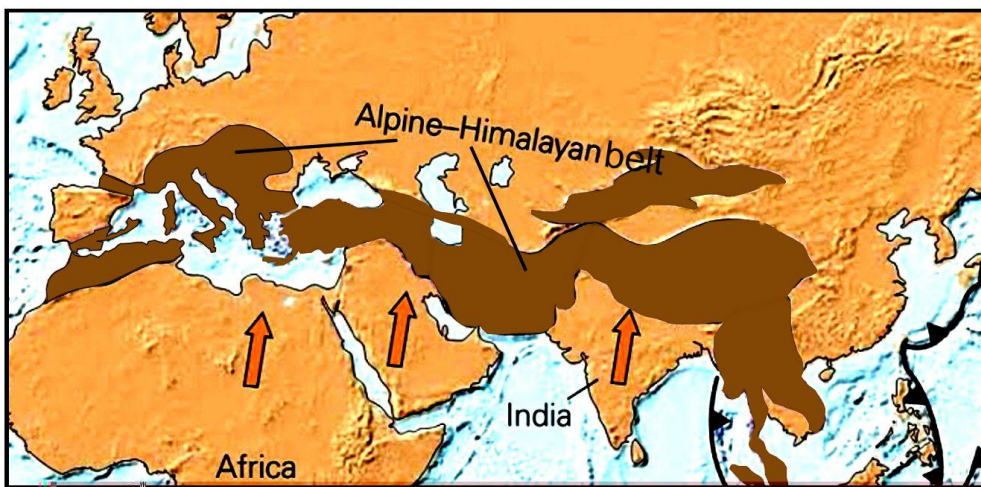
As it can be seen on the map Fig. 16, the area of the ancient isthmus in the Caspian Sea actually coincides with the area of modern oil production, which is reflected in the location of the chain of large oil and gas bearing structures (shown in red). This location of oil and gas deposits is not accidental, but is the result of subduction processes, in which a large thickness of sedimentary rocks, being sublimated and catalyzed by high pressures and temperatures, is tightened into the Benyof zone [14].



**Fig.17. Tectonic map of the Caspian Sea (International Tectonic map of the Caspian Sea and its frames, 2002) [19]**

Basement of platform areas (1 – 4): (1) Early Precambrian, (2) Baikalian, (3) Hercynian, (4) Early Cimmerian; Alpine fold – thrust systems (5, 6): (5) Greater Caucasus and KopetDagh, (6) Lesser Caucasus, Talesh, Alborz; (7) Foredeeps and depressions; (8) Depressions with oceanic-type crust; (9) Tectonic lineaments corresponding to boundaries of large structures; (10) other important lineaments.

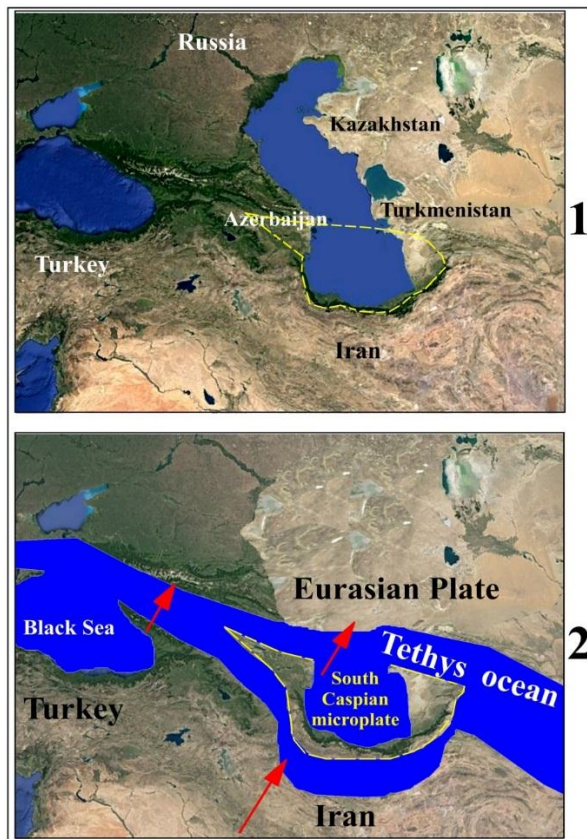
Main structures (letters in circles): (Bz) Buzachi arch, (MU) Mangyshlak – Central Ustyurt, (SM) South Mangyshlak – Ustyurt system of troughs, (TZ) Tuarkyr zone, (KB) Middle Caspian Karabogazanteclise, (EM) East Manych trough, (PK) Kuma system of uplifts, (NS) Nogai scarp, (GC) Greater Caucasus fold system, (KD) Kusary – Divichi trough, (AP) Apsheron Balkhan zone, (WK) West Kopeh Dagh zone, (LC) Lesser Caucasus fold system, (AR) Lower Araks trough, (TL) Talesh zone, (AG) Alborz – Gorganforedeep, (WT) West Turkmen trough, (GD) Gograndagh – Okarem zone. As the researches have shown, the vast majority of oil and gas fields (more than 90%) and closely connected with them mud volcanoes are located in relic or modern subduction zones [5, 6, 7, 9, 10]. As it is known, more than half of all mud volcanoes of the world are concentrated in the territory of Azerbaijan, most of them are located in the water area of the Caspian Sea.



**Fig.18. Overview map of the Alpine-Himalayan folded belt.**

Fig. 18 shows an overview map of the Alpine-Himalayan folded belt, which is clearly seen that the South Caspian basin was a small bay in the Tethys Ocean, and after its closure, it remained a relict closed reservoir with the oceanic structure of the earth's crust. Thus, from the point of view of tectonics of lithospheric plates, the South Caspian basin is a relict of the ancient paleocean Tethys. The gradual closure of the Tethys Ocean as a result of the movement of the African, Arabian and Iranian plates and a number of microplates located between them (including the South Caspian) in the North-East direction, accompanied by the subduction of the oceanic crust of the noted plates to the continental Eurasian plate, brought in the end to the collision and formation of the Alpine-Himalayan folded belt. For clarity, Fig. 19 shows the reconstruction of the last stage of the closure of the Tethys Ocean and the formation of two seas - the Black and

Caspian seas, which were connected at the first stage. Subsequently, as a result of the ongoing process of uplifting the Greater Caucasus, there happened the complete separation of the Caspian and Black Seas. The well-known scientist Berg in his works notes: "It is only certain that in the era of the separation of the Caspian Sea from Pontus (Black Sea), the level of the first one dropped relatively quickly, due to extremely strong evaporation. **In his studies, Berg proves that various parts of the bottom of the Caspian rose or fell, and as a result of this the Caspian disintegrated into two parts, beginning from Absheron above and below, then again merging into a single body of water [1, 3].**



**Fig.19. Reconstruction of the closing time of the ocean Tethys.**

**(drawn by E.N. Khalilov)**

**1 - Current situation of the South Caspian microplate. 2 - The Position of the South Caspian microplate in the Eocene (40 million years B.C.). The yellow dotted line shows the boundaries of the South Caspian microplate.**



## Conclusions

Since the VIII century A.D. as a result of rising water level and active tectonic processes, the bottom of the Caspian Sea deformed, which led to a sharp rise of the Caspian Sea level, while the tectonic block within the Absheron threshold, the western boundary of which passes to the east of the island of Chilov, went down. And as a result of it the confluence of waters of the Middle Caspian and the South Caspian began.

## References

1. A.S. Berg The level of the Caspian Sea for historical time. Problems of physical geography. M., Science, 1987, p.74-75.
2. A.M. Butaev The Caspian: riddles of the level. - Makhachkala: Publishing House of the State University, 1998. - 70 p.
3. Hasan-bey Zardabi. Selected articles and letters. Baku, 1962. <http://zerrspiegel.orientphil.uni-halle.de/t195.html>
4. A.G. Kasymov The Caspian Sea. L., 1987.
5. Sh.F. Mekhtiev, V.E. Khain (Russia), T.A. Ismail-Zade, Spatio-temporal patterns of volcanic eruptions. Papers of the Academy of Sciences of the USSR vol.289, No. 6, 1986, p. 1462-1464.
6. Sh.F. Mekhtiev, E.N. Khalilov Rhythms of earthly disasters. Baku, "Elm", 1988, 109 p.
7. Sh.F. Mekhtiev, E.N. Khalilov Volcanoes and geodynamics. Nature, USSR Academy of Sciences, No. 5, 1987.
2. S.N. Muraviev Five ancient testimonies in favor of the "Ptolemaic" transgression of the Caspian Sea (IV-II centuries B.C.). The oldest states on the territory of the USSR. M., 1986, p.238-247.
3. V.E. Khain, E.N. Khalilov Spatio-temporal regularities of seismic and volcanic activity. SWB, Burgas, 2008, 304 p. (p. 38-40).
4. V.E. Khain, E.N. Khalilov Cyclicity of geodynamic processes: its possible nature M., Scientific world, 2009, 520 p. (p. 130-131).
5. V.E. Khain, M.G. Lomize Geotectonics with the basics of geodynamics. M., MSU Publishing House, 1995, 480 p. (P.290).
6. E.N. Khalilov, Sh.F. Mekhtiev, V.E. Khain On some geophysical data confirming the collision origin of the Greater Caucasus. Geotectonics, USSR Academy of Sciences No. 2, 1987, p. 54-60.
7. E.N. Khalilov Deep structure of the Earth's crust and upper mantle of the Southern Caspian and adjacent regions. Azerb. Oil Economy. #4, 1985
8. E.N. Khalilov About the origin of oil in the Caspian Sea from the positions of tectonics of lithospheric plates. Azerb. Oil Economy, # 10, 1983.
9. E.N. Khalilov About the changes of the water level in the Caspian Sea in connection with global geodynamic processes. Materials of the international

- symposium on the study of geodynamic processes for solving problems of the national economy, Baku, Elm, 1993.
10. E.N. Khalilov, New Data about the presence of the Benyof Zone in the Caucasus-Caspian Region. It was presented by Academician V.E. Khain. Papers of the Russian Academy of Sciences. 2003, Vol. 388., #4, p.542-544
  11. B.A. Shlyamin The Caspian Sea. 1954. Geografiz. p.128.
  12. Bottom Topography of the Caspian Sea. U.S. Naval Research Laboratory, Stennis Space Center. (2007). [Http://www7320.nrlssc.navy.mil/caspian/](http://www7320.nrlssc.navy.mil/caspian/)
  13. International Tectonic Map of the Caspian Sea Region, 2005. V. Khain& N. Bogdanov (eds.). 27r.
  14. [http://www.azerbaijan.az/\\_Geography/\\_Caspian/\\_caspian\\_r.html](http://www.azerbaijan.az/_Geography/_Caspian/_caspian_r.html)

### 3. The great Eurasian bridge

#### 3.1. The experience of Azerbaijan in the application of large hydraulic structures in the Caspian Sea

Geological evidence, confirming historical evidence of passage in the II - VII centuries A.D. across the Caspian Sea, one of the routes of the Great Silk Road, makes it possible to realize the ideas of the great strategists of our time about the reconstruction of the Great Silk Road, in the refraction of the achievements of modern civilization - high technologies in all spheres - transport, telecommunications, space technologies, etc. The Caspian isthmus, which runs along the Absheron threshold, which used to be a land linking the Absheron peninsula to the shore of Western Turkmenistan, can be used for laying the world's longest bridge (205 km) across the Caspian Sea, connecting Europe and Asia. The bridge across the Caspian Sea has a technological prototype - it is a unique town on piles "Oil Stones" with a length of overpasses over 350 km, located in the Caspian Sea 50 km from the shore. **Oil Rocks is a unique offshore field, which was an outstanding event in the development of oil business in the USSR, Fig. 20.** The name "Oil Stones" has historical significance - long before the discovery of this deposit, scientists noticed black, oil-covered rocks in the Caspian Sea. This zone of the marine aquatory was called "Black Stones". Oil Stones at that time were the world's largest offshore oil field, both in terms of the thickness of the deposit and the volume of oil produced.



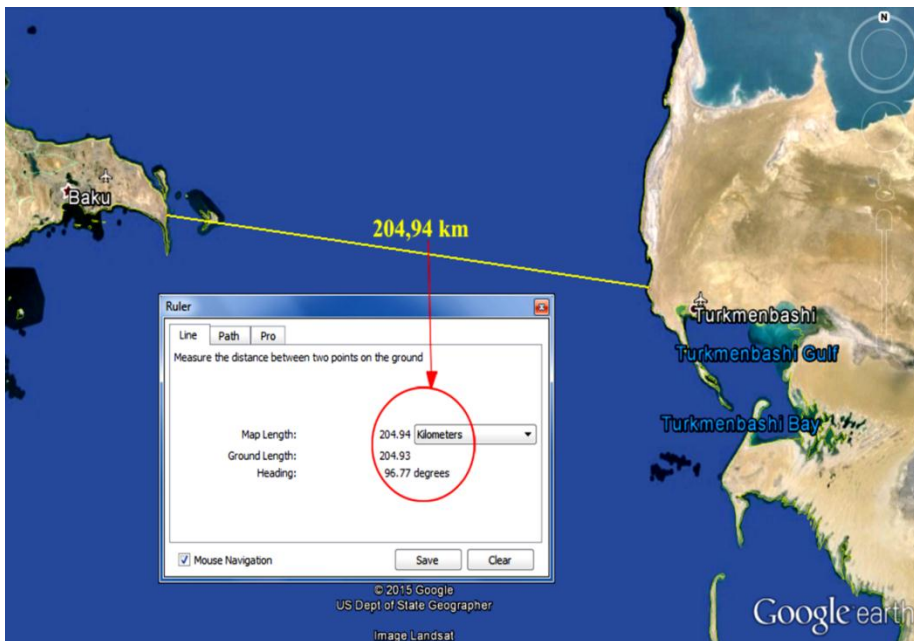
**Fig.20. A unique city on piles in the Caspian Sea - the "Oil Stones".**



**Fig.21. The map of Azerbaijan indicating the location of Oil Stones.**

Oil Stones to this day are a unique city on piles. **For a short time in the open sea, at a distance of 50 kilometers from the coast, large marine crafts were built,**

equipped with first-class, for that time, domestic equipment, Fig.21. In 1951, the industrial development of Oil Stones began. In 1952, for the first time in world practice, the construction of the overpass began, which was supposed to connect the artificial metal islands. At present, Oil Stones is more than 200 stationary platforms, and the length of streets and lanes of this city in the sea reaches up to 350 kilometers. Over the years, this field produced more than 160 million tons of oil and 13 billion cubic meters of associated petroleum gas. There are more than 380 production wells, each of which gives an average of 5 tons of oil per day.



**Fig.22. The length of the bridge across the Caspian Sea is about 205 km.**

Thus, the length of the overpasses of the sea town "Oil Rocks" is 100 km longer than the supposed in the project bridge across the Caspian Sea; and the depths of the sea in both cases are comparable. Considering that the city on piles has been successfully operated and developed for 65 years, while the technology of building bridges in comparison with the 1950s has been incomparably improved, it can be confidently asserted that the bridge across the Caspian Sea is a technologically real and promising project. The length of the planned bridge is 204, 94 km, Fig.22. The maximum depth of the zone in the Caspian Sea, where the planned bridge extends, is 160-170 meters (the length of the section is 4-5 km). About 5 km of the bridge is proposed to pass through the island of Chilov. The information about the depths in the central part of the Absheron threshold needs additional detail and there may be routes with even less depth of the sea.

Chinese bridge constructing companies are leaders in the construction of the most extensive bridges in the world through water areas, especially in seismically active zones. One of the striking examples is the Hanzhou Bridge, which is 36 km long and crosses the Hanzhou Bay in the East China Sea and the Tsiang Tang River connecting the north and south of the country of the rising Sun.

### **3.2. China is the world leader of large bridge construction through water areas in the zones of high seismic risk and difficult weather conditions**

But the most important fact is that the bridge was built in one of the most earthquake-prone areas of China, in the zone of high seismic activity, regular strongest typhoons and fast water currents. The bridge passes in the area of multi-level complex relief of the bottom of the bay, Fig.23.



**Fig.23. In the photos is shown the Hanzhou Bridge**

Although the Caspian Sea in its central part is also characterized by high seismic activity, but the area of the Hangzhou Bay in the East China Sea has seismic risk for an order of magnitude higher than in the Caspian Sea. *As it is known, the Caspian Sea is characterized by frequent storms, while the Hanzhou Bay is known for very powerful typhoons and fast flows. Therefore, we can safely say that the degree of seismic and meteorological risk in the Caspian Sea is much lower than in the Gulf of Hanzhou.*

*This fact removes fears that the seismic risk, sea flows and storms in the Caspian Sea may be an obstacle for the construction of the Great Eurasian Bridge.*

### **3.3. The concept of the possible structure of the "Great Eurasian Bridge"**

The authors, having fallen on the researches, developed a concept of the construction across the Caspian Sea of a large bridge that connects the Turkmen coast with the Absheron peninsula. The infrastructure of the proposed bridge provides for three levels of "floor". At the first level, the authors propose to lay in the construction of a bridge a special tunnel for placing the fuel and energy main pipelines: the pipeline from Kazakhstan and the gas pipeline from Turkmenistan to Azerbaijan, and from there through Turkey to Europe, which will be absolutely environmentally friendly from the point of view of possible pollution of the Caspian Sea. At the second level of the bridge, the authors propose to lay railway lines - for freight trains and high-speed rail for passenger trains. At the third level, it is proposed to place motor roads for freight transport, for passenger transport and a high-speed highway. As it is known, the projects of trans-Caspian oil and gas pipelines along the Caspian seabed from Kazakhstan and Turkmenistan to Azerbaijan are met with serious objections of experts because of the fear of a possible ecological catastrophe in the Caspian Sea in case of pipeline damage, for example, as a result of a strong earthquake. The construction of this bridge with the laying of pipelines on a special tunnel effectively solves this problem. On the certain sections of the bridge it is proposed to build unique complexes in a futuristic style with allocation of Business Centers, magnificent hotels and other facilities. In the future, transport systems of the near-Caspian states can be integrated into the infrastructure of the Great Eurasian Bridge.

### **4. Economic benefits from the implementation of the "great eurasian bridge" project (GEAB)**

The strategy for the implementation of the transnational transport and economic mega-project North-South and East-West, actively promoted by Azerbaijan in cooperation with neighboring countries, will receive another powerful transport-economic artery of continental scale. Currently, 99% of cargoes from China to Europe are delivered by sea, it is more than 1 billion tons per year. And only 1% is delivered by rail, road and air transport taken together [5, 6].

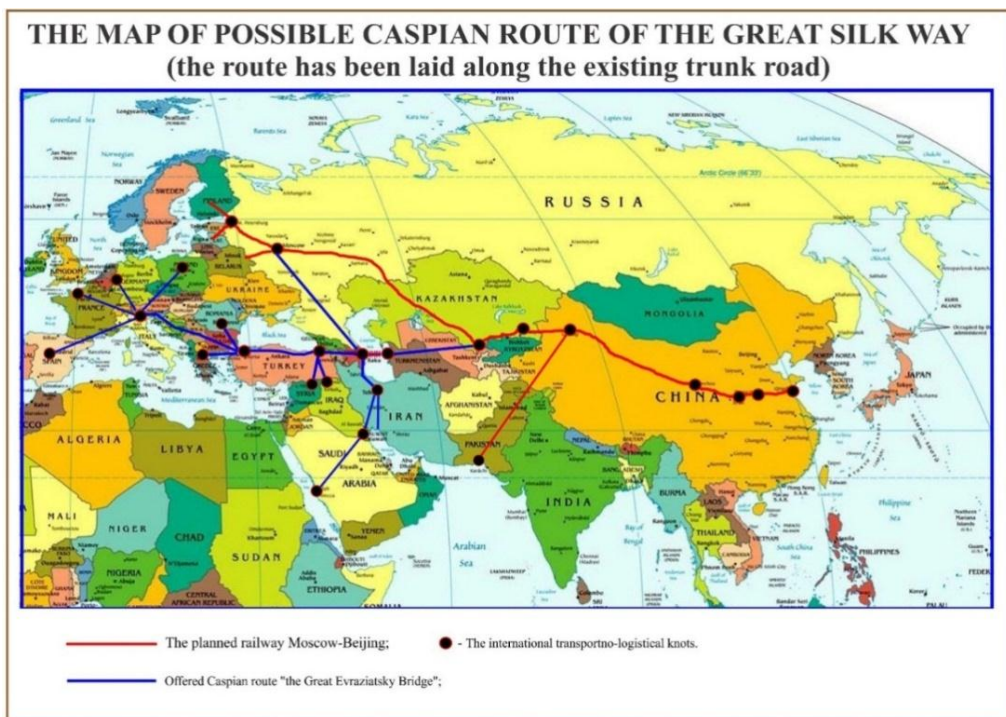
Currently, the formation of the Trans-Caspian route has moved from the theoretical stage to the stage of practical implementation [3, 5]. It is this route that is distinguished by experts, as the most promising [7-8]. According to experts' opinions, up to 10 million tons of cargo per year can pass through the International Sea Port of

Alat via the existing Trans-Caspian route. Azerbaijan plans to receive more than \$ 2 billion a year income from transit of goods. In addition, if the cargo from China to Europe now comes for 40-45 days by sea, the cargo through the port of Alyat will go for 12-14 days [1, 2]. On the other hand, if to compare - this is the shortest existing corridor and it is shorter than the northern corridor by 4.5 thousand km and the Southern Corridor by 1.2 thousand km. Preliminary calculations show that, through the Caspian bridge, having both the railway and road routes, it will only be in the first years of operation, according to the most conservative estimates, up to 300 million tons of cargo. And in future this figure will exceed 500 million tons per year, taking into account the constant increase of cargo flows along this route. The construction of the Caspian bridge should be accompanied by the expansion of the capacity of existing transport corridors from China to the Caspian coast and from Azerbaijan to Europe. Only Azerbaijan will have about \$ 30 billion a year in transit for cargoes, and in the next years this figure will exceed \$ 60 billion per year. On the other hand, if the sea route from China to Europe is 40 to 45 days in transit, and 12-14 days through the port of Alat, the transportation of goods along the "Great Eurasian Bridge" will take 4 to 5 days. This will also allow opening of new giant export and import markets for perishable goods between Asia and Europe, which cannot be transported by sea because of long transportation time. When using high-speed passenger trains, widely used by China, when the average speed of the train will be more than 200 km / hour, passengers will be on the way from China to Europe no more than 2 days. As it is known, the projects of trans-Caspian oil and gas pipelines along the Caspian seabed from Kazakhstan and Turkmenistan to Azerbaijan are met with serious objections by experts because of the fear of a possible ecological catastrophe in the Caspian Sea in case of pipeline damage, for example, as a result of a strong earthquake. The construction of this bridge, with the laying of pipelines on a special tunnel, effectively solves this problem. According to the initial estimates of experts, the cost of building GEAB together with the coastal transport and logistics infrastructure will cost about \$ 80 billion, and including the cost of construction and reconstruction of rail and highway integrated into the project and passing through the territory of other countries from Asia to Europe, will be about \$ 200 billion.

### **5. A new format of geopolitical and economic integration**

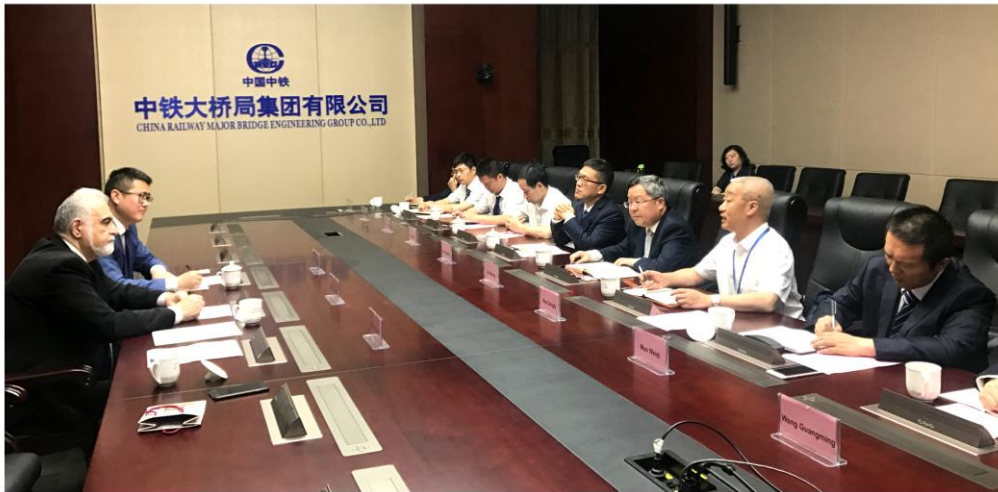
"The GREAT EURO-ASIAN BRIDGE" may become the largest international economic, cultural, geopolitical and transport-logistics project of a global scale of the third millennium. The creation of transport, energy, cultural and intellectual ties in the Europe-Asia system requires several alternative routes from the countries of Asia in the North-West (Beijing-Moscow-Europe) and West-South-West (China-Azerbaijan-Turkey-Middle and Near East and South Europe) directions. The issue of the North-

Western route has practically been solved at the political level between China and Russia. The western route runs through the countries of Central Asia, the Caspian Sea, Azerbaijan, Georgia and Turkey and further to the countries of Southern Europe and the Middle and Near East. The "Great Eurasian Bridge" project will completely solve the problem of creating an economic corridor in the West-South-West direction, which will contribute to a more harmonious development of the economy of the giant region. GEAB will make the transport-economic, fuel-energy, cultural, social and intellectual corridor Europe-Asia more reliable and safe. In addition, GEAB can become the main economic core for the Eurasian Union, the ideological initiator of which is Russia. The "Great Eurasian Bridge" is the way of creating "One Eurasia" - a new cultural and economic formation based on all-round development, friendship, cooperation and economic prosperity.



**Fig.24. A map of the prospective routes of the GSR in case of realization of the GEAB project.**





**During the official meeting of the President of WOSCO (Germany), President of IAS-AS, Prof. Dr. Elchin Khalilov with the Chairman of China Railway Major Bridge Engineering Group – PhD Liu Ziming (within the framework of GEAB project discussion), 17 May 2018, China.**

## CONCLUSION

### Main results of the researches

In the international project GEAB an attempt has been made to generalize the main steps of a very complex and multifaceted movement aimed at restoring the Great Silk Road in the new geopolitical and economic format of the third millennium. Sequential and purposeful actions of the main participants of the strategic concept of modern GSR have been shown.

On basis of historical and geological studies, the authors of the project were the first to substantiate the existence of the land bridge through the Caspian Sea, connecting the Absheron Peninsula with the coast of Western Turkmenistan in the II-VII centuries of our era. On this isthmus passed one of the most active routes of the Great Silk Road. The authors, drawing on the studies, developed a concept for the construction across the Caspian Sea of a large bridge connecting the Turkmen coast with the Absheron peninsula.

The concept of forming the infrastructure of the proposed bridge provides a three-level structure. At the first level, it is proposed to place main trans-Caspian oil pipelines, gas pipelines, optical communication lines and other main communications. At the second level it is proposed to place the railways: for freight and passenger high-speed trains. The third, the uppermost level is proposed to be used to accommodate highways: for the trucks, the passenger motor vehicles and high-speed roads for motor cars. The bridge will have the ability of further integration of transport systems of the Caspian states.

***Thus, the "Great Eurasian Bridge" is not just a large transport infrastructure, it is a transnational economic -megastructure with a new philosophy of economic and geopolitical integration.***

## References

1. Jamila Alekperova. Azerbaijan on the "Silk Road". Business Time. 09/23/2016. [Http://btime.az/page.html?id\\_node=415&id\\_file=6403](http://btime.az/page.html?id_node=415&id_file=6403)
2. Zh.T. Kudyarova Trans Caspian international transport route and its influence on international logistics. Journal Science, Technology and Education. No. 4 (22), 2016, pages 71-75.
3. The first container train passed through the trans-Caspian route from China to Azerbaijan. Journal Transport. [Http://transport-journal.com/news/pervyj-kontejnernyj-poezd-proshel-po-transkaspyskomu-marshrutu-yz-kytaya-v-azerbajdzhan/](http://transport-journal.com/news/pervyj-kontejnernyj-poezd-proshel-po-transkaspyskomu-marshrutu-yz-kytaya-v-azerbajdzhan/)
4. "The International Association of the Trans-Caspian International Transport Route" was established. [Http://www.tks.ru/logistics/2016/10/10/0010](http://www.tks.ru/logistics/2016/10/10/0010)
5. Study of logistics of trade operations with China. <https://studydoc.ru/doc/2640542/issledovanie-logistiki-torgovyh-operacij-s-kitaem>
6. Transport policy and strategy for the development of railways at the turn of the 60th anniversary of OSZh D. [Http://osjd.org/statico/public/en?STRUCTURE\\_ID=5190](http://osjd.org/statico/public/en?STRUCTURE_ID=5190)
7. The struggle for the Chinese transit is exacerbated. Izvestia 100. <http://izvestia.ru/news/637707>
8. General concept of development of international transport corridors. [Http://www.morinfocenter.ru/smp.asp](http://www.morinfocenter.ru/smp.asp)

## **CHINA'S ONE BELT AND ONE ROAD INITIATIVE AND AZERBAIJAN'S TRANSPORT CORRIDOR STRATEGY**

**Renying li**

*Public Diplomacy Institute of Shanghai  
Cooperation Organization of Shanghai University  
lry1982asbj@163.com*

The National Development and Reform Commission of the People's Republic of China, the Ministry of Foreign Affairs of the People's Republic of China and the Ministry of Commerce of the People's Republic of China jointly issued a "Vision and Action to Facilitate the Construction of the Economic Belt of the Silk Road and the Sea Silk Road of the 21st Century", proposing to use Xinjiang's unique geographical advantages west. For this purpose, the creation of a cultural, scientific and educational center within the economic belt of the Silk Road was proposed. To deepen the exchange and cooperation with countries of Central Asia, South Asia and Western Asia, it is necessary to create an important transport hub, trade logistics. [1]

The Silk Road is an ancient commercial land trade route that originated in ancient China, connecting Asia, Africa and Europe. His initial role was to transport silk and porcelain from ancient China, and then became the backbone of the economy between East and West. The Silk Road is the main road to integrating the economy, politics, culture and many other aspects of the life of all the countries involved. Based on the type of cargo transportation, the Silk Road routes are mainly divided into land and sea [2].

The overland Silk Road begins with Chang'an (now Xi'an), the ancient capital of China, and reaches the Mediterranean Sea through the Hexi Corridor, Central Asia, Afghanistan, Iran, Iraq, Syria, etc., ending in Rome, with a total length of 6,440 kilometers. This road is considered to be the intersection of ancient Eastern and Western civilizations of the Eurasian continent, and silk is the most representative cargo [3].

More than 2,000 years ago, the maritime silk road, starting with ports such as Xuven and Hepu port in China, created the world wide trade network. In the Tang Dynasty, there was a sea route called "Guangzhou Tunghai Yidao" on the southeast coast of China. This is the earliest name of the sea Silk Road in China [4].

In September 2013, during his visit to Kazakhstan, the President of the People's Republic of China, Xi Jinping, first put forward a program to build the Silk Road Economic Belt [5]. Xi Jinping, in the report "Promoting Friendship for the Better People" at Nazarbayev University, proposed the idea of jointly building the "Silk Road Economic Belt". Xi Jinping said he hopes that thanks to the strengthening of political

ties, access to roads, uninterrupted trade, currency circulation and people's hearts and ears, European and Asian countries will seek closer economic cooperation, deeper mutual cooperation in all areas and expanding space for development.

Later, when Xi Jinping visited Indonesia in October 2013, he proposed a joint initiative to develop the 21 st century's sea silk road in Indonesia [6]. For the first time, the proposed initiative of cooperation in the field of the Silk Road of the 21st century, was formed in the Chinese initiative “one belt and one road”. Trade Minister Zhong Shan said that the “one belt” initiative was approved by more than 140 countries and regions, and cooperation in the “belt and way” framework brought fruitful results. Firstly, the scale of trade is constantly expanding, and secondly, the investment area is also constantly growing. China has invested over \$ 60 billion in related countries, including many agricultural industries. Thirdly, large projects are actively promoted, a number of railway and port projects are completed and are at the final stage. In a number of economic and trade cooperation zones, more than 27 billion US dollars were invested [7].

Since the opening of the first “Central European Train” in March 2011 to August 2018, many countries and cities have joined this railway. In August 2018, after the CEIBS X8044 train arrived in Wuhan, the number of CEIBS trains reached 10,000 [8]. A review of bilateral trade between China and the EU in 2017 shows that the annual volume of imports and exports exceeded 600 billion US dollars [9]. On June 29, 2015, Prime Minister Li Keqiang attended the China-EU Business Summit in Brussels, where he delivered a keynote speech. Relations between China and the EU have successfully passed through 40 years of history and continue to grow steadily. The cooperation between China and the EU is based on the principles of mutual benefit. Successfully overcoming existing problems and “trade friction”, it is possible to hope that the volume of trade in 2020 will reach \$ 1 trillion [10]. As of June 2018, Sino-European trains reached 45 domestic cities, and their number will increase in the future [11].

The increase in trade between China and the EU is directly dependent on the cost and time of China-European trade freight. Traditional maritime trade usually takes 30-45 days or even two months from the main port cities of the southeastern coastal ports of China, which greatly affects the development of Chinese-European trade. With the advent of Belt and Roads, the development of high-speed railways, the maturity of high-speed rail technologies and the resumption of land transport corridors from China to Europe have become a reality today and in the future.

Azerbaijan is located at the junction of Europe and Asia; it is the key position of the “crossroads” of the “heart zone” of Eurasia, the east-south corridor and an important node of the continental transport hub.

In May 1993, a conference was held in Brussels with the participation of representatives from five countries of Central Asia and three Caucasian countries, where

the European Union proposed the TRACECA project. At this conference, a program of technical assistance to the project from the European Union was agreed. The technical assistance program covers the development of a transport corridor passing through Europe to the Black Sea, from there to the South Caucasus and the Caspian Sea to Central Asia.

The favorable geographical position of the Republic of Azerbaijan, its role as an important point of the transport corridor and the promotion of its foreign economic policy supporting integration into the world community, was also reflected in the implementation of the TRACECA project. The idea of implementing the TRACECA project reached its culmination on September 8-9, 1998 in the capital of the Republic of Azerbaijan, Baku. An international conference dedicated to the restoration of the Great Silk Road was held in Baku these days. At the Baku International Conference, plenipotentiaries of 32 countries and 13 international organizations signed a very important document - "The main multilateral agreement on international transport for the development of the Europe-Caucasus-Asia corridor" (Basic Agreement), reflecting the technical and economic issues of the Europe-Caucasus-Asia transport corridor. In preparing this document there are invaluable merits of the President of the Republic of Azerbaijan Heydar Aliyev. Two days after the end of the Baku International Conference dedicated to the restoration of the Great Silk Road, President of Azerbaijan Heydar Aliyev held a meeting in connection with its results. The meeting, which was attended by the highest official circles of the country, given the further growth of the value of the Eurasian transport corridor in the 21st century, noted the need for serious preparatory measures in this area in our country, the acquisition of new vehicles and the creation of modern service industries. The intensive activity of the Eurasian transport corridor, the Transcaucasian corridor in the socio-economic life of Azerbaijan, in solving its problems is also of great importance. This was mainly manifested in the income received from cargo transportation, in the creation of a reliable market for sea and rail transport, pipeline transport, in the reconstruction of infrastructure sectors related to cargo transportation in the country, in the opening of new jobs, in economic development security of Azerbaijan, in the development of Baku as the largest port in the center of this trunk line and on the coast of the Caspian Sea.

It is not by chance that the headquarters of the Permanent Secretariat of the Intergovernmental Commission TRACECA is located in one of the main points of the GSP - the capital of Azerbaijan, Baku. The office of the Permanent Secretariat of the TRACECA Intergovernmental Commission began its activities on February 21, 2001 in Baku. A new office serving as a coordinated organization of work under the TRACECA program was created to regulate the transport and movement of international goods under the IDP, to assist in resolving issues related to legislation and the financial and economic environment in countries that have joined the Basic Agreement [13].

At present, Azerbaijan is a participant in the Silk Road Economic Belt project, implemented on the initiative of China. In December 2015, within the framework of the state visit of President Ilham Aliyev to China, a memorandum of understanding was signed between the Government of the Republic of Azerbaijan and the Government of the People's Republic of China regarding the joint promotion of the creation of the Silk Road Economic Belt [12].

A Memorandum of Understanding on Transport was signed between the Ministry of Transport of the People's Republic of China and the Ministry of Communications of the Republic of Azerbaijan.

Traditionally, Azerbaijan is an important source of energy production and exports in the world. In Soviet times, Azerbaijan took advantage of rich oil and gas resources. It was the only republic, except Russia, which did not require subsidies from the Soviet central government.

The Contract of the Century, signed in September 1994 to lay the foundation for the creation of Azerbaijan, is also based on the development of the economy of Azerbaijan in the development of energy. The economy of Azerbaijan is affected by fluctuations in world oil prices. During the period of international growth in energy prices in 2000-2008, the economy of Azerbaijan achieved significant success. In recent years, due to the influence of the international economic and financial crisis and the low level of world energy prices, Azerbaijan's economy is seeking to further expand the non-energy economy based on the energy economy. In this context, the government formulated the "Development Strategy for Azerbaijan 2020" in 2012 and plans to reach 80% of GDP from non-oil targets by 2020.

Traditionally, Azerbaijan is an important source of energy production and exports in the world. It was the only republic, except Russia, which did not require subsidies from the Soviet central government.

The Contract of the Century, signed in September 1994, laid the foundation for the creation of Azerbaijan's economy based on the development of energy. Azerbaijan recognizes that with the development of globalization and the changing mode of economic growth, countries can find a suitable development mode in their own country to take place in the global economic system. Due to its unique geographical position, Azerbaijan becomes an ideal intercontinental trade and transport hub.

### **1. The main situation with the movement in Azerbaijan under the vision of "One belt, one road"**

At present, Azerbaijan's inland transport is mainly based on rail and road transport, while international transport is mainly based on road, rail, air and sea routes. In addition,

Azerbaijan, as one of the energy-exporting countries, pays great attention to the main pipelines (gas and oil pipelines).

In Azerbaijan, there are mainly three international highways, mainly in the direction of Georgia with a total length of 503 km, the Iranian direction (Baku-Astara) with a total length of 521 km; Baku-Cuba-Siazan-Makaram Kent, Russia, with a total length of 245 kilometers. With 25,000 km of roads, the main expressway is concentrated in the Azerbaijani section of the TRACECA corridor, about 521 km. I.

Azerbaijan has a total length of 59,000 kilometers, a national highway with a length of 6882 kilometers and a local highway with a length of 18,000 kilometers. In Azerbaijan, there are mainly three international highways, mainly in the direction of Georgia (Baku-Jan-Age border) with a total length of 503 km, the Iranian direction (Baku-Astra) with a total length of 521 km; Baku-Cuba-Siazan-Magerrammkent, Russia, with a total length of 245 kilometers. With 25,000 km of roads, the main expressway is concentrated in the Azerbaijani section of the TRACECA corridor, about 521 km.

The railway is of great importance when planning a transport corridor in Azerbaijan. As of 2015, Azerbaijan has a total of 2,932 kilometers of railways. Among them, 1,272 kilometers - electrified railways, which account for about 60% of the total length of the railroad, 845 kilometers of railways, and 12 container sites. The international railways of Azerbaijan are mainly connected with the Georgian railways. The direction of freight traffic is also mainly in Georgia, which account for more than 70% of freight traffic in Azerbaijan. Due to the long-term operation of the cargo, most railways in Azerbaijan need to be repaired or updated. At present, there is no high-speed railway in Azerbaijan.

Sea transportation is an important part of Azerbaijan's road traffic, mainly between countries along the Caspian Sea. In Azerbaijan, the largest port in the Caspian Sea. The modern seaport of Baku was built in 1902 and is the largest and busiest passenger, cargo and oil ports in the Caspian Sea. It is associated with Russian cities: Astrakhan, Makhachkala and Ola. (Ola); Turkmenbashi in Turkmenistan; Aktau in Kazakhstan; Anzeli in Iran, Amirabad, Noushkar, etc. The port has close business contacts.

In the aviation sector, Azerbaijan currently has five international airports in Baku, Ganja, Nakhichevan, Zakatala and Lankaran, of which Baku is the busiest airport in the Caucasus.

After the signing of the "Contract of the Century", the transportation of oil and natural gas from the Caspian Sea region became a strategic option for Azerbaijan. As a result, Azerbaijan built four energy pipelines (three oil pipelines and one gas pipeline): to the north is the Baku-Navorossisk oil pipeline to Russia with a total length of 1,330 kilometers and an annual transportation volume of 5 million tons. The West passes through the Baku-Supsa pipeline. Supsa, the Black Sea port of Georgia, with a total length of 833 kilometers, has an annual capacity of 15 million tons. Baku (Azerbaijan)

- Tbilisi (Georgia) - Jay Khan (Turkey) (BTC: Baku-Tibilis-Ceyhan) with a total length of 1,768 km and an annual carrying capacity of 50 million tons. The Baku-Tbilisi-Erzurum gas pipeline has an annual capacity of 20 billion cubic meters. In addition, the proposed “transit Anatolian gas pipeline TANAP”, which is expected to transport 16 billion cubic meters of natural gas to the European market annually.

Through the construction of the above-mentioned transport infrastructure, Azerbaijan will transport oil and natural gas to the markets of Georgia, Turkey and Europe and become an important center of the Caucasus. In addition, Azerbaijan also proposed to reduce taxes, simplify procedures, improve professional standards in the Azerbaijani sector, actively participate in a number of regional projects in the fields of energy, transport and information technology and further strengthen the strategic positioning of Azerbaijan in the infrastructure construction of Eurasia.

The basic traffic situation in Azerbaijan is very representative for the countries involved in the Belt and Road, i.e. the existing transport infrastructure is lagging behind the needs of the economy. Through the construction of the above-mentioned transport infrastructure, Azerbaijan will become an important center of the Caucasus.

## **2. Plan of transport infrastructure of Azerbaijan within the framework of the concept of “Belt and Road”**

The transport situation in the country reflects the economic level of the country for a certain period of time. In addition to addressing the needs of the country's own population and freight traffic, the development of the transport sector also reflects the country's understanding of the environment for economic development, the potential for economic development, relations with neighboring countries and its position on the world map. In 2010, the Azerbaijani government adopted the “2010-2014 Azerbaijan State Railway Development Plan” for Azerbaijan to carry out a comprehensive renewal and transformation of the railway, including careful maintenance of the 940-kilometer railway, improve the work of emergency trains, early warning systems and automated control system, update cars and locomotives.

To increase the speed of passenger and trucks up to 100 km and 80 km, respectively, the total investment is about 1.146 billion manat (about 1.43 billion US dollars). On this basis, investments in the railway industry in Azerbaijan continued to grow in 2015, reaching 226 million manat (about \$ 215 million), an increase of 40.9%. Baku International Airport has reached 3 million passengers a year. Over the past ten years, Azerbaijan’s investments in the transport sector accounted for 21% of total investments in the economy. Such continuous and huge investments are unprecedented in the history of transport development. Transport Infrastructure Plan of Azerbaijan within the framework of the “Belt and Road” concept. Thus, all parties have high hopes



for planning not only the railway development of Azerbaijan, but also the whole of Eurasia. Azerbaijan is actively rebuilding its 21st century in the planning of a transport hub to make Azerbaijan a transport hub connecting Europe and Asia. In the new planned transport hub of Azerbaijan, the strategic concept is to create a trans-Eurasian transport network from Russia to the Persian Gulf. Further from the Persian Gulf, to East China to China and the West to Europe, where Baku is the main capital. Transmitting stations in Asia and Africa have made Azerbaijan an important transportation hub connecting the excellent trade routes of the Pacific, Indian Ocean and Atlantic. In the end, Azerbaijan became the center of population, logistics, capital flow and energy consumption in Eurasia and completely got rid of landlocked countries. To this end, Azerbaijan has developed several major plans for the development of a transport hub, the main ones are: the Europe-Caucasus-Asia transport corridor (TRACECA) connecting Eurasia and the North-South International Corridor (INSTC), which passes through the North and South. The Baku-Tbilisi-Kars (BTK) project, which has a project of the Baku International Sea Port, which plans to revive the Silk Road from Asia to Europe and rebuild the North-South corridor. A common feature of all these plans in Azerbaijan is the emphasis on the position of Azerbaijan as the main center.

The work of the book by the famous Azerbaijani scientist Talekh Vidzhadov “Azerbaijan will become the regional center of Central Eurasia” tells about the strategic understanding of the transport hub, strategic vision and major project plans by Azerbaijan.

Representative important work. The transport infrastructure strategy of Azerbaijan has many opportunities to strengthen the infrastructure under the “Belt and Road” initiative in China. Many Chinese scientists participated in the “Inviting Scientists” program of the International Development Agency of the Ministry of Foreign Affairs of Azerbaijan and fully understood the development strategy of the transport hub of Afghanistan. The parties also fully developed and exchanged their own development strategies through recommendations meetings, bilateral or multilateral international conferences.

The transportation plan for the transport infrastructure of Azerbaijan will be considered as part of the “interconnection” of China’s infrastructure “One belt, one road” We will have a deeper understanding of the construction of transport infrastructure in the Caucasus and even in Europe and Asia.

### **3. Plan of the transport corridor Europe-Caucasus-Asia**

In May 1993, a meeting of the EU, the Transcaucasian countries (Azerbaijan, Armenia, Georgia) and five countries of Central Asia was held in Brussels. After the meeting, they signed the project “The third corridor Europe Caucasus Asia”. At the

European Transport Conference 1998 in St. Petersburg, Russia refused the TRACECA project, taking advantage of the host country. However, the Russian approach was not supported by European and foreign Caucasian countries. In April 1998, the International Conference “The Great Silk Road”, held in Baku, continued to adhere to the TRACECA initiative and proposed to revive the “Ancient Silk Road”. Subsequently, in September 1998, an intergovernmental committee and a permanent secretariat were established in Baku, Azerbaijan. Currently, it mainly consists of 13 countries. In 2004, at the Ministerial Conference in Baku on the theme “Coordination of energy and transport between the EU and the Caspian Sea and Black Sea partners”, the importance of TRACECA in the form of “Baku Initiative” was reaffirmed. The Europe-Caucasus-Asia Transport Corridor (TRACECA) is a transport project financed by the European Union, which the European Union strongly supports and plans to link the line to the Trans-European Transport Networks (TEN) and the Pan-European Highway (TEM), Trans-European Railways (TER), combine to create a corridor between Europe and the main markets in East Asia and South Asia. The focus of this project is on the construction of railway infrastructure in the countries of the South Caucasus and Central Asia. Azerbaijan plays a very important role in this project, since the land and sea transport component connecting Europe and Asia is mainly completed in Azerbaijan. In this corridor, the Azerbaijani and Georgian segments are the busiest, mainly carrying oil and chemical products from Azerbaijan to Georgia. At the same time, this corridor is also the most direct and fastest way to connect China to European railways. The Europe-Caucasus-Asia Transport Corridor (TRACECA) is a European Union-funded transport project, which the European Union strongly supports and plans to link the line to the Trans-European Transport Networks (TEN) and the Pan-European Highway (TEM), Trans-European Railways (TER), combine to create a corridor between Europe and the main markets in East Asia and South Asia. The focus of this project is on the construction of railway infrastructure in the countries of the South Caucasus and Central Asia. Azerbaijan plays a very important role in this project, since the land and sea transport component connecting Europe and Asia is mainly completed in Azerbaijan. In this corridor, the Azerbaijani and Georgian segments are the busiest, mainly carrying oil and chemical products from Azerbaijan to Georgia. At the same time, this corridor is also the most direct and fastest way to connect China to European railways.

In order to fully realize the unique geographical advantages of Azerbaijan in this project, Azerbaijan is preparing to invest significant funds to upgrade railway locomotives, railway lines, power systems, signal systems and facilitate the management and financial status of the railway system. The European Bank for Reconstruction and Development also provides specialized financial support services. The study of the mechanism of operation, the cost of transit traffic and the tax rate of the project

TRACECA are of great reference value for the international railway transport system of China -Kyrgyzstan-Uzbekistan

#### **4. Plan of railway transport Baku - Tbilisi – Kars**

In the Baku-European section, Azerbaijan focuses on promoting the “Iron Silk Road”, the Baku-Tbilisi-Kars (BTK) railway project. Turkey is the first country to recognize the independence of Azerbaijan. Both countries have a good relationship. After Georgia and Azerbaijan were independent, they established a close strategic partnership. In July 2002, the three countries signed an agreement on the accession of Azerbaijan and Turkey through Georgia, using land ferries for land and sea transport, and then connected with Azerbaijan through the Caspian Sea and the railways of Kazakhstan, thus connecting Turkey, the Caucasus, the Middle East and Asia.

The newly formed land corridor from Europe to China was planned to be completed in 2010. Later, due to the influence of the Russian-Georgian war and the global economic and financial crisis, the restructured plan will be completed in 2017. According to the data of 2015, the route can transport Korean cargo to Turkey via China-Kazakhstan-Azerbaijan-Georgia. Rail transport takes only 15 days, which is almost half the time of shipping, and the carrying capacity is about 17 million tons per year.

After the completion of the submarine tunnel in Marmara in Turkey, the BTK railway will connect the Caucasus and the European railway network. In the future, transit time of goods from China through Baku to Europe will be reduced to six days.

The disadvantage of this route is the replacement of ports in Kazakhstan and Azerbaijan and the transformation of broad rails into narrow rails in Europe on the border between Georgia and Turkey, which, to a certain extent, limits logistics. Azerbaijan hopes to further improve the efficiency of transportation from China to Europe through cooperation in customs clearance along the route.

Currently, the project is partially open to traffic. Thanks to the latest technologies, the railway is currently the most advanced railway line.

Taking into account the relations of Azerbaijan with Armenia, Azerbaijan is committed to the policy of isolating Armenia from all regional projects. It will also be an important diplomatic step for solving the Azerbaijani problem.

In addition, the Baku-Tbilisi-Ceyhan (BTC) railway and oil pipeline project, the Baku-Tbilisi-Erzurum gas pipeline project form the trinity Europe-Caucasus-Asian transport corridor, where Azerbaijan plays an important key role.

## **5. Plan of the Southern Transport Corridor**

The southern corridor of Azerbaijan is designed to connect Azerbaijan with the Iranian railways in order to achieve plans to reach Russia and Northern Europe from South Asia or to connect China, East Asia to Turkey, the Mediterranean and southern Europe. In April 2016, the Shuang Railway was launched, connecting Astara, Iran and Astara, Azerbaijan. The railway has a length of 10 kilometers, of which 8 kilometers pass through Azerbaijan and 2 kilometers within Iran.

After the construction of the Shuang railway is completed, the railway networks of the two countries will be connected to each other and will be connected to Russia through Iran through Azerbaijan. In this regard, Azerbaijan and Iran have become important transportation hubs for connecting

Europe and Asia and connecting waterways. At the same time, this plan will also help Azerbaijan to connect the “enclave” of Nakhichevan with Iran to the mainland.

Currently, Iran has 181,000 kilometers of roads, the total length of the railway is about 13,000 kilometers, and 3,355 kilometers of railways are under construction. Iranian railway gauge is 1435 mm, which coincides with Turkey, China and Europe. These linked railways will pass through Azerbaijan.

At present, the level of development of the Iranian railway is relatively close to Azerbaijan, and only a small part is the electrified railway. The Iranian Railway (RAI) has developed a \$ 25 billion railway project and a “incentive plan” to attract domestic and foreign investment. It is planned that by 2025 the existing Iranian railway line will be electrified and two-way, and a new railway line with a length of 12,000 kilometers will be built, which ultimately will double the total length. By that time, the southern transport corridor that Azerbaijan expects will be realized as a result of the continuous development of the Iranian railways.

## **6. International North-South Transport Corridor**

In choosing a route on the Western Front, Armenia and Azerbaijan became two competing routes. Armenia was blocked by Azerbaijan and Turkey, and its railway line could enter Russia only through Georgia, but the 2008 Russian-Georgian war made transport cooperation between Russia and Georgia mostly stagnant. On the contrary, the Azerbaijani route has significant advantages of high convenience and with good safety. However, at present, the main flow of goods in the North-South transportation corridor lies between Russia and Iran, and only a small percentage of goods pass through Azerbaijan.

At present, Azerbaijan is actively participating in the North-South international transport corridor and is building a part of the railway connecting some domestic railways with the international railway network of North-South corridors.

There is no railway connection between Azerbaijan and Iran. Currently it is just a motorway. However, despite the sanctions imposed by the West against Iran, Iran has strengthened its ties with countries such as Azerbaijan and Russia. On August 6, 2016, Russian President Putin and the President of Iran specifically arrived in Baku, the capital of Azerbaijan, and discussed with the President of Azerbaijan, Ilham Aliyev, the North-South international transport corridor and related issues. The International Transport Corridor of the North South (INSTC) has historically been an ancient business trip route connecting South Asia and Northern Europe. The new international North-South transport corridor was originally initiated by Russia, Iran and India in St. Petersburg on December 12, 2000.

It entered into force on May 21, 2002, after approval by its internal procedures. In February 2005, the heads of the Ministry of Railways of Russia, Iran and Azerbaijan met in Baku to discuss a concrete plan for connecting the Qazvin-Resht-Astara railway. In July 2005, a meeting was held in Tehran, which officially launched the North-South International Corridor project, which is connected with Russian Astrakhan in the north, Baku in Azerbaijan and Nhava-Sheva in India in the south. With a total length of 521 kilometers, including three routes by rail, waterway and highway, it is planned to transport some goods from South Asia without passing through the Suez Canal, but by land to the Middle East, Russia and Europe, as well as from India to Delhi via Baku to get to the vast region of Helsinki, Finland.

With an increase in the number of member states, this plan now has three channels: China, the West and the East: the center line is also the first initiative to be reached by Finland, Helsinki via St. Petersburg to Astrakhan or Ola (Ola) in Russia, and then through Iran. Ports Enzali and Noushahr arrive in India, the western line runs along the western coast of the Caspian Sea through Azerbaijan to Iran and India, which is also the shortest land route, the east through Russia, Kazakhstan, Turkmenistan.

In railway construction, the railway rules of Russia and Azerbaijan are 1,529 wide rails, India uses 1,674 wide rails, and 1,435 calibrators are used in Europe, Turkey, the Middle East, North Africa and China. Because of the problem of the calibration distance, it is still necessary to switch the rail to the western line, but with the development of technology these technical problems will be solved.

## **7. Azerbaijan - Ukraine - Belarusian - Lithuanian railway transport corridor**

In May 2016, Azerbaijan also signed an agreement on the accession of the Azerbaijan Railway to the Viking transport corridor between Ukraine and Belarus and Lithuania, using Azerbaijan to connect Europe and Asia with its unique geographic location connecting the Baltic Sea with the Black and Mediterranean Seas. It will better serve the promotion of Eurasian logistics and domestic economic development. The Azerbaijan National Railway Company and the Lithuanian National Railway Company signed an agreement on cooperation in the field of multimodal transportation in Vilnius and discussed the prospects for Azerbaijan's participation in the Viking container train transport project.

The agreement contributes to a further increase in transit traffic of Azerbaijani goods. The project for the transport of container ships "Viking" was implemented in 2003. The total length of the transport line is 1766 kilometers. She participates in the state of Ukraine, Belarus, Lithuania, Latvia and Bulgaria. The first batch of Ukrainian container trains arrived in China on January 31, 2016. The route is one of the most convenient routes, and, at present, passes Russia to transport European goods to China.

## **7. Baku International Sea Port Project**

But in the late 1990s, the Soviet Union fell into depression. After the new independence of Azerbaijan, the government convened in 1998 an international conference on the Silk Road to further strengthen the status of the Baku International Port.

The originally planned project of the Baku International Sea Port was scheduled for completion in 2017. He plans to increase the capacity to 11.5 million tons per year, transfer 50,000 standard containers and create a "free trade zone of Ariat" in the Baku International Port Area. However, in recent years, the decline in world oil prices has reduced the income of the Arab Oil Fund by half, and state finances are in a dilemma. Major infrastructure projects in Azerbaijan were affected, including a number of important projects involving the Great Silk Road.

They also influenced the second stage of the project "New International Airport in Baku", and it can be expected that international oil prices will increase or receive new international financing. Azerbaijan showed a positive attitude towards the promotion of China's "One Belt, One Road" initiative and an increase in AIIB investments in transport infrastructure.

To this end, in the east of Baku, Azerbaijan is trying to create a new Baku international trade port to the Caspian Sea. Currently, the first stage of the Baku Trade

Port has been completed. At the end of the third stage, the annual throughput capacity will be 25 million tons of cargo and 1 million TEU, which will become the largest trade and logistics base in the Central Caspian. In order to build a new Baku international port at the regional pole of economic growth, Azerbaijan created special economic zones around the port zone, hoping to rely on the new Baku international port to attract foreign funds, technology, talent and goods, as well as to promote the economic development of the country and the whole Caucasus.

Currently, the development plan of the transport hub of Azerbaijan has achieved good economic results with China's "belt and road". In August 2015, the first international train of China arrived in the port of Baku through the Caspian transport corridor, and in January 2016, on the 15th, the first freight train from Ukraine to China began trial operation of an international transport corridor through the Caspian Sea from Europe to China.

Specific transport route: from the port of Illichivsk to Odessa, Ukraine through the port of Batumi, Georgia (1040 km), Batumi to the port of Alat (Baku port) (825 km), Baku port to Kazakhstan Aktau port (511 km), Aktau to Dostyk station (3095 km) arrived at the Alashankou station with a total history of 5,471 km. Based on the current actual operating results, although this international transport corridor is not the most economical transport corridor (which will be re-established by two land and sea transportation), it will be the fastest transport corridor (will be supplied by Chinese goods). Delivery time to Europe is reduced to 15 days). In October 2016, Azerbaijan, Kazakhstan and Georgia created the Inter-Caspian International Association of Transport Channels.

Azerbaijan is strengthening consultations with countries on how to attract more international goods to China or Europe through the channel and seeks to make this transnational channel commercial.

Attractive transport corridor. By strengthening cooperation in the field of transport, China and Azerbaijan can not only promote the process of diversified economic cooperation between the two countries, but also accelerate the pace of trade between the countries along the Eurasian continent and introduce new development in regional economic cooperation between Europe and Asia. power. The Chinese initiative "One Belt, One Road" and the plan of the transport hub of Azerbaijan are making every effort to realize their dreams of the "Silk Road" more pragmatically, which will bring more comfort and well-being to the people of the Caucasus and vast areas of Eurasia.

### **The 2nd Belt & Road Forum in Beijing Belt and Road Forum 2019**

On April 25-27, the Second High Level International Forum on International Cooperation in the framework of the "One Belt and One Way" was successfully held in

Beijing. It was attended by 37 leaders of states and governments, including Russian President Vladimir Putin. The event was also hosted by the Managing Director of the International Monetary Fund, Christine Lagarde, and the UN Secretary General, Antonio Guterres. A total of 283 practical results were achieved during the preparation and holding of the forum. At a conference of chief executive officers (CEOs) within the forum, cooperation agreements worth over \$ 64 billion were signed. This shows that more and more countries are becoming partners of the One Belt and One Way Initiative, seeking to strengthen interconnectedness and achieve common development and prosperity.

According to research reports by the World Bank, the implementation of the One Belt and One Road Initiative has increased trade flows between member countries by 4.1% and reduced transportation time globally by 1.2–2.5%, as well as reduced overall trade expenses of 1.1–2.2%. "During the implementation of the initiative, direct investment has increased worldwide." The implementation of the "One Belt and One Path" stimulates the development of the world economy and optimizes global governance, while laying the foundation for the realization of joint development and prosperity.

As chairman Xi Jinping noted at the forum, the joint implementation of the "One Belt and One Path" meets the historical trends of economic globalization and the requirements for reforming the system of global governance. It will create the best conditions for the life of the peoples of all countries [14].

## References

1. [http://www.xinhuanet.com//finance/2015-03/28/c\\_1114793986\\_2.htm](http://www.xinhuanet.com//finance/2015-03/28/c_1114793986_2.htm)
2. 丝绸之路 HYPERLINK "https://baike.baidu.com/redirect/9529tO7bXNvVh-xHEZSMEtjBa770A14F6ikgCFAAtG621hHvGavvMUF-zYQbg3vbxcj9MyKwbx-UYQ83xwTxKdsodWLzfe0LhZiN-xhbGJ1VowTgQhDUbnQ" . 新华网[引用日期 2016-03-16]
3. [https://baike.baidu.com/item/%E2%80%9C%E4%B8%80%E5%B8%A6%E4%B8%80%E8%B7%AF%E2%80%9D%E6%80%BB%E8%A7%84%E5%88%92%14307487?fr=aladdin#ref\\_\[1\]\\_14116351](https://baike.baidu.com/item/%E2%80%9C%E4%B8%80%E5%B8%A6%E4%B8%80%E8%B7%AF%E2%80%9D%E6%80%BB%E8%A7%84%E5%88%92%14307487?fr=aladdin#ref_[1]_14116351)
4. <http://opinion.people.com.cn/n/2014/1019/c1003-25861481.html>
5. 海上丝绸之路千年兴衰史 HYPERLINK "https://baike.baidu.com/redirect/0a60yDFLccjmtDKDoIPF8O81RD5R1FWdLvJSljE7wJwEEU0yJ-83cMQENcIw6GofdN-uJIXbq8MStAEZiU7IfbQIM2TOQDXrVOCUqol6DvL\_-8yZvyG4NF4J2A" . 人民网[引用日期 2016-03-16]
6. <http://history.people.com.cn/n/2014/0520/c385134-25040882.html>
7. 习主席首次提出“丝绸之路经济带”为啥选在这儿？



8. <http://www.chinanews.com/gn/2017/06-08/8245060.shtml>
9. 习近平:中国愿同东盟国家共建 21 世纪"海上丝绸之路"
10. [http://www.xinhuanet.com/world/2013-10/03/c\\_125482056.htm](http://www.xinhuanet.com/world/2013-10/03/c_125482056.htm)
11. 商务部: 一带一路有 140 多个国家和地区的积极响应
12. <http://fec.mofcom.gov.cn/article/fwydyl/zgzx/201803/20180302718703.shtml>
13. 中欧班列的 10000 次出发, 送去带来的是什么?
- i. [http://www.sohu.com/a/250336905\\_162281](http://www.sohu.com/a/250336905_162281)
14. 2017 年中国与欧盟 27 国双边贸易概况: 进出口额超 6000 亿美元
15. [http://www.askci.com/news/finance/20180507/095217122717\\_2.shtml](http://www.askci.com/news/finance/20180507/095217122717_2.shtml)
16. 李克强: 中欧贸易额 2020 年达到 1 万亿美元
17. <http://money.163.com/15/0630/09/ATBM052900253B0H.html>
18. 中欧班列国内开行城市达到 45 个
19. <https://finance.sina.com.cn/stock/usstock/c/2018-06-07/doc-ihcqqcip7430572.shtml>
- <https://finance.sina.com.cn/stock/usstock/c/2018-06-07/doc-ihcqqcip7430572.shtml>
20. Восстановление Великого Шелкового пути
21. <https://ru.president.az/azerbaijan/silkroad>
22. Общая историческая справка к разделу «Транспортный коридор Восток-Запад».
23. <http://lib.aliyevheritage.org/ru/6345926.html>
24. "Один пояс и один путь" помогает в создании открытой мировой экономики.
25. <https://ria.ru/20190427/1553116035.html>

## ABOUT AZERBAIJAN MODEL OF DEVELOPMENT AND ITS RESULTS

**Ziyad Samedzade**

*National Assembly of the Republic of Azerbaijan,  
Chairman of the Committee on Economic Policy, Industry and Entrepreneurship,  
Chairman of the Union of Economists of Azerbaijan*

In June 1993, Heydar Aliyev returned to big politics in Azerbaijan, developed a development strategy in accordance with the historical and economic characteristics of Azerbaijan, the mentality, geopolitical conditions, national interests of the country to eliminate a serious catastrophe and adopted well-thought-out and reasoned system measures: establishing cooperation with international organizations developed countries, and setting priorities for economic reform. It was a very difficult period. More than 80% of the population lived in poverty. Hundreds of enterprises ceased their activities, and most of the active population was left without work, Azerbaijanis, who were expelled from their homeland by Armenian nationalists, faced serious difficulties.

Heydar Aliyev chose a well-planned strategy to revive the prosperous economy of Azerbaijan and ensure the protection of our state as a whole, and stressed that using the oil factor is the only way out of this strategy. In 1994, the Republic of Azerbaijan signed the “Contract of the Century” with the world's largest oil companies. It was the historic success of the independent state of Azerbaijan, its president, and the creation of favorable opportunities for Azerbaijan to actively participate in world integration.

In the second half of the twentieth century, many countries, including those who were defeated in the war and freed from colonialism, faced a choice: on what basis should the economic recovery and the path to development be developed? To this end, global research has been promoted in leading countries of the world, and research centers have been established for prediction. The concept of the future of the world has been prepared. The United States dominated the liberal development model, the Swedish classical social model. While the American model provides for tough market relations, free competition, minimization of state intervention in the economy and minor differences in income diversification, the “Swedish model”, on the contrary, eliminates social injustice, redistribution of income between groups, the main level of obligations. Unlike these development models, the Asian countries — South Korea, Malaysia, Singapore, and China — in the late 1970s, Germany and Japan, who were defeated in World War II, preferred each other's development patterns and made great strides.

At the end of the first decade of the 21st century, these countries demonstrated their commitment to minimizing the impact of the global financial crisis.

For 28 years of its independence, Azerbaijan has undergone a major breakthrough, has become a state with a strong economy, ensuring its economic security. The successful implementation of the Azerbaijani development model created a new economic system based on free market relations in the country, provided a transition period in the economy and created powerful foundations for the prosperity of the people.

Heydar Aliyev did not agree to privatize the oil sector, despite the serious pressure on our state. He firmly stated that the natural resources of Azerbaijan belong to our state, our people and will never be privatized. The oil industry is the foundation of the economic independence of our state. This approach is one of the most important aspects of the development of Azerbaijan.

Oil is a great policy, oil is a great economy, and the struggle for oil is becoming more and more global.

Today, Azerbaijan is known as an active player in world oil policy, a country that ensures the energy security of Europe. Formation of cooperation with foreign companies, improving the investment climate, investing in our country, increasing their efficiency. Today there is quite a lot of potential in the private sector of Azerbaijan. Its share in GDP exceeds 80 percent. Based on international experience, we can say that this is a fairly high figure. The key issue is the diversification of the private sector, improving the efficiency of small and medium businesses. By the way, it should be noted that in the last years of the twentieth century, oil prices on the world market dropped significantly. Those who are skeptical about the economic development of Azerbaijan accuse the government of Azerbaijan of difficulties due to lower oil prices, saying that oil will be "bitter" for our country. They were wrong. Because Heydar Aliyev believed in the future of Azerbaijan. At the same time, the Azerbaijani government is implementing a set of measures and programs to prevent the negative impact of global economic development trends on the country's economy from the point of view of our national interests. Large-scale projects are being implemented to develop the non-oil sector and diversify the structure of the industry so that the bulk of the economy does not fall on the oil industry.

We must agree with this idea that the abundance of natural resources does not mean progress. In many oil-producing countries, economic development and living standards are very low. Because in these countries there is neither political stability nor a development strategy that would regulate national interests. Azerbaijan also has political stability, an oil strategy that serves the wealth of our people for national interests. We have to build our business so that the economic shocks that suddenly occur in the world do not cost us too much. Over the past 20 years, there has been a sharp increase in the dynamics of oil prices on the world market, but it has played an

exceptional role in strengthening the economic and political foundations of the financial base of the country's economy. At present, the State Oil Fund of Azerbaijan has a large amount of funds. The strategy of the government of Azerbaijan to effectively use these funds and ensure its transparency is determined. Today, the most influential experts and leaders of leading international organizations of leading states highly appreciate the work done by them to solve this fundamental problem. Because Azerbaijan has created a management system for the State Oil Fund in accordance with international standards. Azerbaijan is a member of the British initiative on the transparency of oil revenues. The Fund regularly informs the public about the amount of funds raised and the flow of these funds. The use of certain revenues of the Oil Fund to solve the most acute economic and social issues, as well as the preservation of a large part of this money as a strategic reserve for future generations, is a very important guarantee of the dynamic development of Azerbaijan. Those who did not understand the essence of the development policy of the Azerbaijani state, saw that the oil strategy has no future, should not pay attention to this sector, should privatize the oil sector. Those who say that “damned resources” cost us more than the “Dutch syndrome” forget that the Azerbaijani state, its founder Heydar Aliyev strengthened the foundations of our independence, giving priority to the oil factor, and had a historical chance to overcome the country's crisis, which was successfully implemented. Thus, a strong investment flow began in our country, the economy of Azerbaijan, primarily the oil sector, joined the international business life. The oil strategy has created a solid foundation for the development of democracy in our independent republic, ensuring social and political stability, strengthening national state-building and its return to the world economy. The oil factor will continue to function as a leading strategic sector of the economy for many years and will play an important role in maintaining state independence. Without the oil factor, the flow of investment in Azerbaijan today would not be so great, and we would have faced great problems and threats during the transition period. Particular attention is paid to the development of entrepreneurship in the country, which is very important for the effective functioning of the new economic system.

Evaluating entrepreneurship as a strategic resource for economic development, the Azerbaijani government consistently and systematically fights for the development of the private sector, the formation of property relations, the removal of barriers for small and medium-sized businesses and the creation of a favorable business and investment environment. The formation of national entrepreneurs in the country, the formation of the middle class and the rational use of local resources are considered to be the leading trends in the strategy of economic development. One of the factors determining the dynamic development of the economy of Azerbaijan is the successful implementation of effective state regulation of the economy. In an environment where global risks are increasing, a regulatory mechanism must exist for a long time. There

should be an optimal threshold for economic openness. The minimization of state regulation of the economy is an approach that does not meet the national interests of our state. The level of state participation in the economy varies depending on the specific features of the development of each. Azerbaijan has been subjected to aggression by Armenia. Nagorno-Karabakh, the ancient land of Azerbaijan, is still occupied by the Armenian occupation, despite four UN resolutions. But this fact is a serious factor in determining government regulation. On the other hand, the successful implementation of development policies in such a situation and thoughtful government regulation are an objective necessity. “Modern state”, agreement with the idea of economic freedom means a blow to national sovereignty in the context of globalization. Naturally, such an approach cannot be adopted by the state and its citizens. It should be noted that this current economic policy is in the national interest of the country.

The Azerbaijani government does not like the idea of “everything is decided by the market”, and it is important to keep up with the country's economic security. This is a logical consequence of this approach to ensuring the economic security of the country so that the financial crisis in the world does not cause serious shocks to the economy of Azerbaijan. I would also like to touch on another issue. In most countries of the CIS and Eastern Europe in the early 1990s, property relations, the unequivocal disintegration of state property and the rapid development of private property were noted, which were considered as the main directions of economic reforms.

Unlike the rigid recommendations of the IMF, in China it did not make any revolutionary changes in property relations when implementing reforms, and it was also appropriate to use other forms of ownership. Considering that rapid privatization can cause significant damage to the economy and exacerbate the socio-political situation, China has seriously taken up this issue and considered the importance of maintaining state separation.

The Chinese, Japanese and Koreans preferred not radical measures, but the idea of the evolution of real miracles. We live in a period that is not easy in our history. Having gained sovereignty and national independence, the republic began to build a society on a democratic basis and became an active participant in market relations. One of the most important projects implemented in the country over the past 15 years is to ensure the balanced development of the regions. Elimination of discrepancies in the development of regions is very important for the dynamic and high-quality development of the entire national economy. Comparative studies show that the development and implementation of regional development programs create opportunities for the effective use of existing economic and labor potential, create broad opportunities for the development of all forms of ownership, including private entrepreneurship, and form municipal property. The implementation of 4 targeted programs for the rapid

development of regions in 2004–2018 has created a solid base for strengthening positive trends in the economic and social life of the regions.

Numerous production facilities have been established in the regions. Important infrastructure projects are being implemented, the process of forming industrial centers is accelerating. In the coming period, the economic and social problems of the regions and cities of the republic will be resolved faster and will ensure the balanced development of the country as a whole. In connection with all this, as an economist, I believe that there should be different economic mechanisms (in a certain sense) for creating the necessary production and social infrastructure in remote mountain regions, for developing entrepreneurship and attracting investors to these places. This experience has been and is in the developed world for a long time. We should use this experience to take into account the peculiarities of our republic.

This is an objective necessity. All our activities should serve the national interests and the revival of the national economy. Some experts disagree with the idea that "a market economy is the elimination of all discounts." For a long time, the growth rates of the population and labor resources in our republic were higher than in many countries. In the Soviet period, there were discrepancies between labor resources and newly created jobs in our republic.

After the collapse of the USSR, this discrepancy in the first years of independence became even stronger. Tens of thousands of jobs were cut using hundreds of enterprises. During the years of independence, especially in the conditions of stabilizing tendencies in the economy, the possibility of creating new jobs in the sphere of production and social services has expanded. Creation of new jobs was defined as a strategic direction of economic policy. As a result of the development of entrepreneurship, the implementation of regional development programs, hundreds of thousands of jobs have been created. In our opinion, the problem of demographic development and employment should be the focus of attention in the coming period. The introduction of new innovative technologies and the development of the digital economy, first of all, exacerbate the problem of employment; additional systemic measures should be envisaged.

Creating a sectoral structure focused on the development of informal areas, as well as an assessment of promising projects along with other indicators, as well as the level of employment, should be considered as one of the strategic goals of management structures to create a balance of labor resources for each city and region. In our society, a consensus has been reached on the general directions of development of our republic. The model of development of Azerbaijan was determined taking into account the geopolitical conditions, trends and national interests of the world economy and the potential of our republic, and this development will serve the progress of Azerbaijan for many decades.

To do this, fuel and energy transport should be the focus of increasing productivity, non-oil industry, the agricultural sector and the service sector. Experts today evaluate the use of human capital as a key factor in economic and social progress. The implementation of this direction will contribute to the preservation of national and moral values, will contribute to human civilization. By the way, I should also note that our great poet Mikayil Mushfig, who fell victim to repressions in 1937, called humanity an inexhaustible capital. 15-20 years ago, the financial resources of our country were low, and therefore we felt a serious need for borrowing from abroad. In many cases, the IMF puts us in very difficult conditions. Now the situation has changed significantly, and the financial capabilities of our republic have improved significantly. Today, Azerbaijan has become a lender of the borrowing country. Now, in the area of debt, the government has the opportunity to think deeply, explore and analyze it. Currently, the ratio of external debt to GDP is only 19%. Foreign exchange reserves of our country are 7 times higher than foreign debt.

As a result of the country's financial resources, budget revenues, improved parameters of the state budget, budget expenditures and public debt management, the share of the state budget in GDP has increased significantly. Keeping this tendency towards improving the indicators of the country's social development, it should be assessed as a strategic task in terms of elimination and quality of life. Our comprehensive studies show that the goals and objectives of our country are developing on the basis of the development model of Azerbaijan, which was clearly defined and ensures a high quality of life. After that, the parallel and systematic implementation of economic and political reforms becomes a powerful factor in the development of quality.

The dynamic development of the country's economy should be considered as one of the most important goals, which should be achieved by improving its performance indicators. Our economists should expand their research to protect national sovereignty and high-quality economic development in conditions of heightened global risks.

# ARCHITECTURE AND CONSTRUCTION

## USING UTILIZED METAL-CORD TIRES IN GEOTECHNICS

<sup>1</sup>Gabibov F.G., <sup>2</sup>Shokbarov Y.M., <sup>3</sup>Gabibova L.F.

*Azerbaijan Scientific Research Institute of Construction and Architecture, Azerbaijan,  
E-mail: farchad @ yandex.ru.*

*Kazakhstan Scientific Research Institute of Construction and Architecture, Kazakhstan,  
E-mail: eralykarakat @ mail.ru.*

### Abstract

Utilized automobile tires are the main messiest kind of common wastes. In order to produce automobile tires in the world they spent synthetic and natural rubber (more than 15 billion tons a year) and in the end, all produced tires are turned into wastes in a certain time. The time of using automobile tires is less than that of other rubber things. The authors made of utilized tires seismic steady foundation, vibroisolated foundation, arched foundation, the taped foundation, with higher flexibility, round monolithic foundation, new construction of taped foundations, drainage constructions, constructions of breast-walls and construction of a ground dam with anti-seismic belts. The investigations carried out and technical solutions worked out let us affirm that using utilized metal-cord tires in geotechnics let partly solve not only a separate engineer-ecological problem, but also achieve technical and economical effects.

### Introduction

Utilized automobile tires are the main messiest kind of common wastes. In order to produce automobile tires in the world they spent synthetic and natural rubber (more than 15 billion tons a year) and in the end, all produced tires are turned into wastes in a certain time. The time of using automobile tires is less than that of other rubber things. The quantity of utilized tires is tremendous, for example, in the USA that is 18 billion tons, in Japan – 750,000 ton annually. There are different technologies of reproducing utilized automobile tires. They consider obtaining energy by burning utilized tires, rubber crumbs, powder and regenerator by their crumbling. Nowadays the part of utilized metal-cord tires is more than half of their total number. The whole utilized tires



are used when building artificial reefs which are fish and oysters, habitats. Sea water is not polluted at the same time. Utilized tires are also used to strengthen slope against erosion. There are many inventions by means of which tires are used in erecting various hydro, road and nature protective constructions.

## 2. Known constructions of foundations

The first constructions made of utilized tires were worked out more than 20 years ago in Azerbaijan Scientific Research Institute by the engineer F.G. Gabibov.

The construction of a seismic steady foundation (1989) of building 1 of rigid constructional scheme consisting of main piles 2 jointed above by high rostverk. 3. with the help of hinges 4 and additional piles 5 used as elastic limiter of oscillations (Fig. 1). The heads of the piles are in the hollow of utilized metal-cord tires 6 rigidly fixed to the lower part of the rostverk with the help of one of their butt-end sides.

When the construction of a building gets into the zone of resonance oscillations, its amplitude rises and additional piles 5 start to work. For a short time the construction amortizsively changes its rigidity and automatically comes out of resonance regime owing to durable rubber forced glasses 6 and the lack of clearance between the elements of the limiter. Amortisive exit out of resonance regime as well as extra elastic resistance to horizontal displacement not only protects from inadmissible displacements in the main joints, but also does not let striking forces appear in the constructions of the limiters.

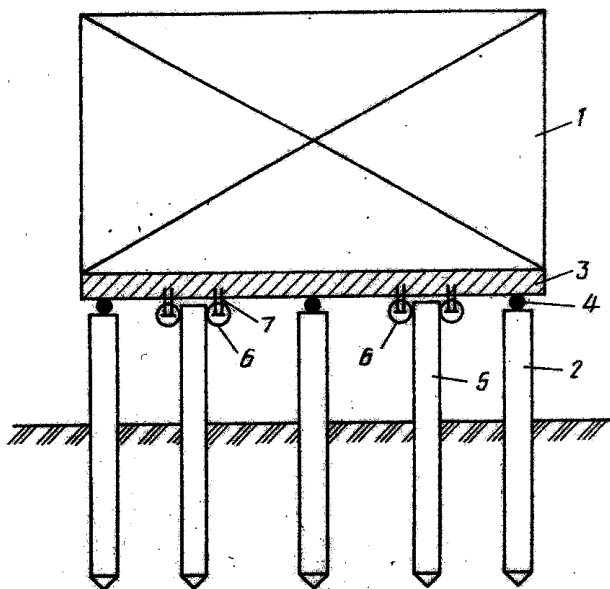
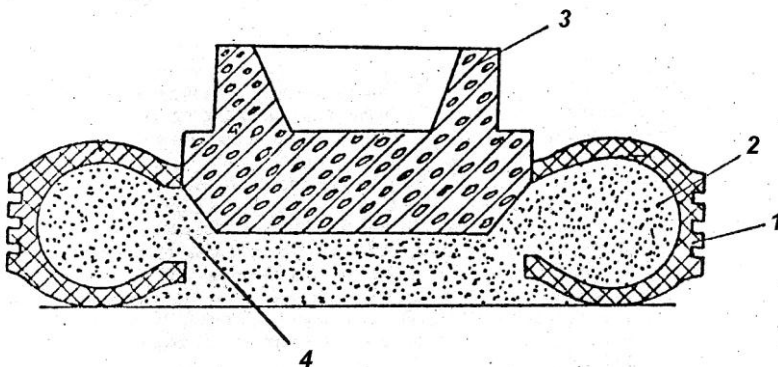


Fig. 1. Seismic steady foundation

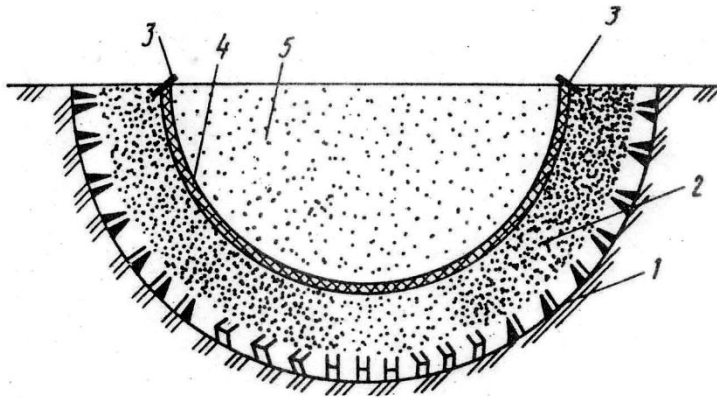
The construction of vibroisolated foundation with utilized tires (Patent of the USSR № 1730364, 1992) consists of casing 1 filled with dry substance 2 and boot 3 placed in the casing with clearance at its side walls and partly deepened into the dry substance Fig. 2. The side surface of the boot in the area of its deepening into the dry substance is declined at the angle not more than the angle of internal friction of the dry substance. Casing (1) is made of utilized tire having chink 4 on the internal surface and the diameter of boot 3 is equal to the internal diameter of casing 1. The force transferred from boot 3 is transferred through dry substance 2 to the flanges and the side surface of casing-tire 1 owing to its declined side surface. That considerably rises the bearing ability of the foundation, as well gets dempfer damping of dynamic forces.



**Fig. 2. Vibroisolated foundation**

In the way of building of arched foundation (Patent of the USSR № 17354982, 1992) they fix conductor 2 made of utilized tires of big automobiles sawed into halves in trench 1 having semi-round surfaces. They cover conductor 2 with flexible panel 4 made of protector cuts of a utilized tire. Panel 4 is fixed on lugs 3 which are the ends of conductor 2. Ground 5 is filled back on to flexible panel 4 with condensation and the hollow formed in conductor 2 is filled with concrete Fig. 3.

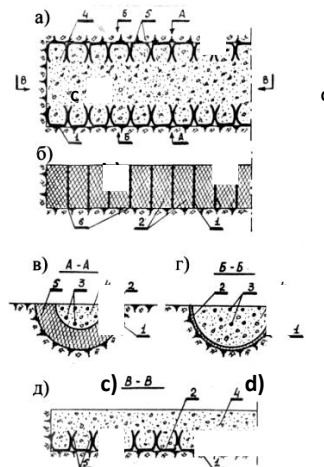
The effectiveness of the method mentioned is reduction of prices and simplifying conducting work by making undertaken off conductor made of wastes specific properties of which also provide hydroisolation and seismic isolation of an arched foundation.



**Fig. 3. Arched foundation**

The monolithic taped foundation with higher flexibility (Patent of the USSR, №1744 200, 1992) consists of utilized tires 2 cut into halves with frame work 3 set in them which are laid into a semi cylindrical trench 1 prepared beforehand and filled with concrete 4 Fig. 4. The side parts of halftires form cuts in the body of the foundation which are filled with packing made of rubber-forced elastic substance.

The formed taped foundation has higher elastic flexibility under any kind of settling or swelling of the base or seismic forces. This way the foundation also has hydroisolation.



**Fig. 4. The taped foundation with higher flexibility:**  
 a) from above ; b) from aside; c) section A-A;  
 d) section B-B; e) section C-C

### 3. The contact problem of interaction of the semi-circle foundation and the base

The contact interaction of the semi-circle surface and elastic base can be described by two of the most used model of E. Vincler and V.Z. Vlasov.

The known differential equation describing the deformations of elastic system is following:

$$DL_1 w = L_2 F, \quad (1)$$

here D-parameter of rigidness, L and L<sub>2</sub>-linear parameters the kind of which is found according to the adopted theory of calculation of the elastic system W (x,x<sub>2</sub>)-components of displacements of the middle surface or sizeless coordinates.

When the system and elastic base interact, external force in i-area of contact is determined by equation

$$F = Q - p', \quad (2)$$

here Q - known external force; p'-reactive force in i-area R<sub>1</sub>, which expression depends on the model of the base.

$$p' = L_3 w; \quad I = 1, 2, \dots, N; \quad (3)$$

N-the number of contact areas, out of contact area F=Q.

For elastic bases described by E. Vincler's and V.Z. Vlasov's models we have properly

$$p' = C_i w_1, \quad (4)$$

$$L_3 = C_{1i} - C_{2i} \quad (5)$$

here C<sub>ki</sub>-the coefficient of bed of elastic base.

The common solution of equation (1) is found as following:

$$w = w_1 + w_2, \quad (6)$$

here W<sub>1</sub>-the known solution of uniform equation,

$$DL_1 w_1 = 0 \quad (7)$$

for elastic system free from forces and  $W_2$  is the solution of non-uniform equation, determined by the character of loading the system and the model describing contact interaction.

$$DL_1W_2 = L_1 F , \quad (8)$$

#### 4. The construction of round monolithic foundation

Monolithic reinforced concrete foundations for columns are widely used in building. The foundations usually have square or rectangular shape. The ones having a round shape are seldom used in practice because of the difficulties in making tubing having a round shape.

In Azerbaijan Scientific Research Institute of Construction and Architecture they worked out the constructions of round monolithic foundation for columns.

Untaken off tabbing (Fig. 5) for concreting stepped round foundations for columns consists of tabbing toroidal blocks 1 and 2 of boot part and toroidal block 3 of undercolumn 5. The blocks made of utilized tires of various diameters are fixed by the help of pintles 4 set on the surface of the block lying beneath after  $120^\circ$  along the circle on the line of touching with the block lying above. Frame work is set and fixed in the hollow of the formed tubing. Over the tabbing they attach hollow-maker 5, after that they fill the hollow of the tabbing with concrete mixture. When concrete becomes tough, hollow-maker 5 is taken off and the foundation is ready for the further montage of the construction.

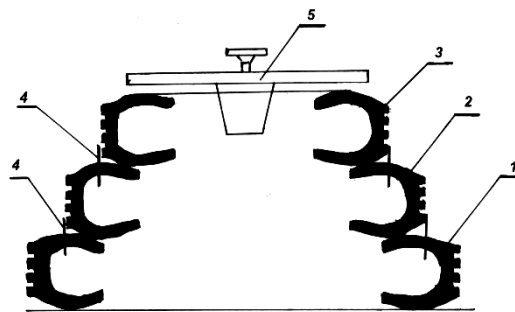


Fig. 5. Round monolithic foundation

When selecting utilized tires the area demanded by the lowest tire forming the lower step of the foundation must be proper to the calculation condition:

$$F_{h.n.} \geq F_p = \frac{N_{\Pi}}{H_{cp} (R^H - \gamma_{cp} H)}, \quad (9)$$

here  $F_{ea}$ -area demanded by the lowest tire,  $F_e$ -calculation area of the foot of the foundation;  $R^N$ -normal pressure to the soil of base;  $N_e$ -calculation force acting along to the unit of width;  $\gamma_{av}$ -average volumetrical weight of the ground;  $H$ -the distance from the floor to the lowest point of the foundation. Not taken off tabbing blocks of utilized tires serve as hydro - and seismic isolation in the built foundation. In the considered foundation they have another considerable advantage. The lower tire forms ring packing easily deformed because of its side flange on the contact surface. It distributes pressure on the foot of the foundation and, thus, increases its bearing ability.

### 5. Working out new constructions of taped foundations

Among innovation types of foundations taped foundations with broken line of supporting plates are more prospective from the point of view of saving materials. Big effectiveness of these constructions is linked to increasing the ratio of the perimeter of the foundation to its areas (it causes the rise of the coefficient of bed), change of the contour of the edge area, which causes the appearance of “arched effect” in the ground base and a more complete usage of bearing ability; besides, areas of plastic deformations of bases of foundations with broken contour of supporting plates is less than that of solid ones. The authors worked out a taped foundation with wavy contour of supporting plates. This construction (Fig. 6) is formed of utilized metal - cord tires 1 closing to each other with the same type and size, which are filled with concrete 2 and have comes out of frame work. In the upper part the round plates are joined with reinforced concrete belt 3. Because of its original shape and special mechanical properties of non taken off tabbing of utilized tires the considered foundation not only has “higher bearing ability” but also gets seismic and hydroisolation.

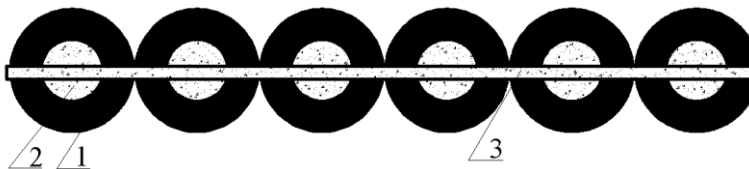
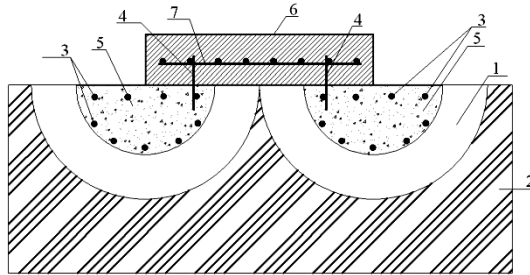


Fig. 6. The taped foundation with wavy contour

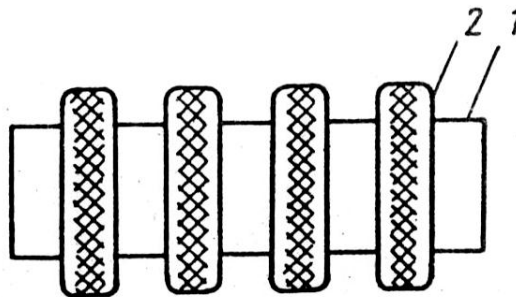
The author’s other work is a taped foundation with cross section like 2 closing semicircles Fig. 7. This construction is formed with utilized tires 1 sawed not to the end into halves, which are laid into the ground bed 2 prepared beforehand in unfolded states.

In the hollow of the tires they set frame work 3 with vertical comes out 4. Then concrete is poured into the hollows. After the concrete becomes solid, the rein forced belt 6 is made, frame work 7 of which is linked to vertical comes out 4. This construction has original supporting shape and elastic dumpfer flexibility is very effective for subsiding soil bases of type № in seismically active districts. The first inventions using utilized tires for working out drainage constructions appeared in the 8-s of the XX century.



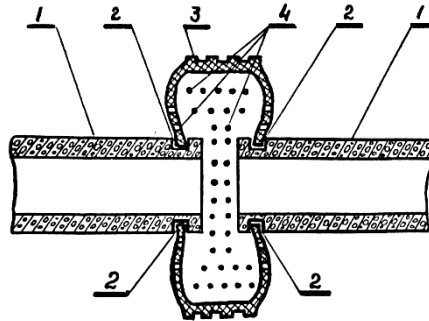
**Fig. 7. The taped foundation of 2 closing semi tires  
6. Working out drainage constructions**

They attached tires to each other in order to form a flexible drainage pipe line to drain ground constructions and as well vertical drainage wells. The construction of a drainage pipe made of segmental cuttings of tires is interesting too. The engineer F.O. Gabibov worked out a method of forming of a drainage filter on the drainage pipes (Patent of the USSR №1587130, 1990). Here perforated metal cord tires 2 are put on the drainage pipes 1 Fig. 8 in the places of perforation. After putting on tires their hollows are filled with drainage substance through elastically opened cuts.



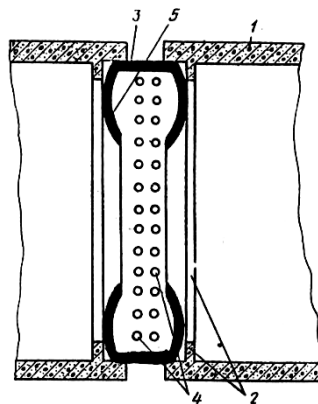
**Fig 8. The drainage pipe with filter**

The authors worked out mufts to unite collection-drainage pipes made of utilized tires. In the first construction Fig. 9 drainage pipes 1 with special slots 2 at the ends are joined with bell and spigot joint 3 with perforation 4 all over the surface.



**Fig. 9. Filter-muft to join drainage pipes**

The second construction of the muft is considered to join collector 2 at the ends are joined with muft-tire 3 with perforation 4. Side flanges 5 of tires are used as preventers water streams in pipes-collectors. In order to strengthen the slopes of ground constructions, roads and canals they often use utilized tires. In Europe, for example in France, utilized tires are used when rein forcing ground constructions.

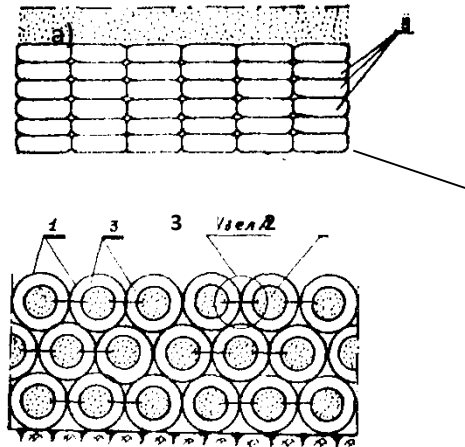


**Fig 10. Muft for joining collector pipes.**



## 7. Construction of breast-walls

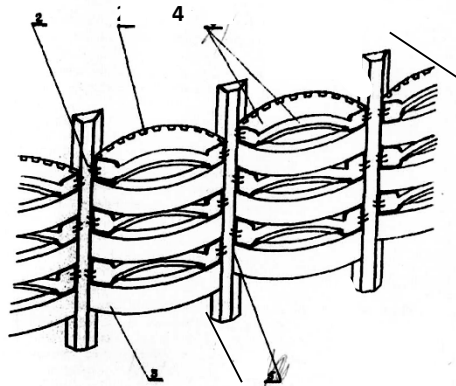
The authors worked out the construction of a breast-wall Fig. 11 consisting of cylindrical casings 1 horizontally laid and filled with soil 2. The cylindrical casing consists of utilized tires 3 closed to each other, which are tied to each other and next to adjacent casing with loops of pulled ropes 4.



**Fig. 11. Gravity breast-wall.**  
a) from above ; b) from the front

Comparing with the known ones this construction of the breast-wall let completely refuse expensive reinforce concrete casing constructions. The expenses on building materials on average are discounted by 85-90 per cents.

The breast-wall with arched elements Fig. 12 consists of vertical supports 1 having trapezoidal cross section with frame-work coming out 2. Reinforced concrete arched barriers are placed between vertical supports 1 and made of sections 3 set vertically with clearance. Flexible arched elements 4 of tires sawed into halves face with salience in the opposite direction from the slope and are placed between sections 3.

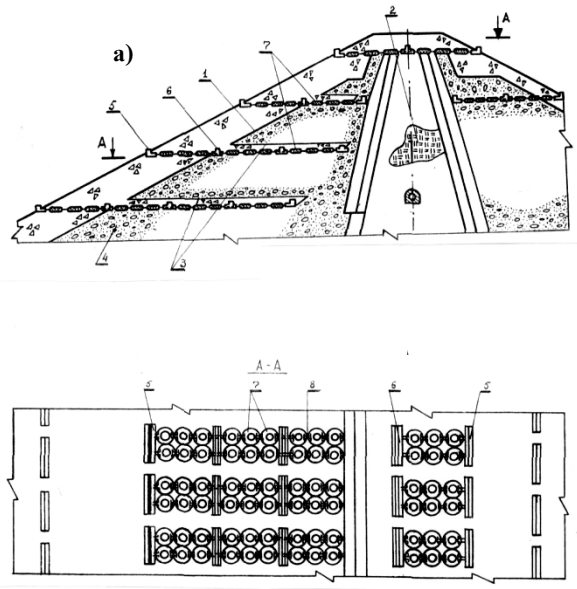


**Fig. 12. The breast-wall with arched elements**

While setting on supports 1 flexible arched elements 4 are partly unbent and sat through the holes bored at their ends on frame-work coming out 2, which are bent in the direction of supports 1. The flexible arched elements of utilized tires-halves work much better than the elements made of metal nets. They are simpler and cheaper.

### **8. The construction of a ground dam with anti-seismic belts**

In the known constructions of ground dams with anti-seismic belts laid in support prisms and made of special reinforced concrete beams and plates joined to each other with flexible frame joints. The authors worked out a ground dams Fig. 13 consisting of support prisms 1 made of sand and gravel mixture, core 2 made of clay and anti-seismic belts 3 set in the support prisms horizontally as large cells filled with drainage material. Anti-seismic belts 3 consist of cross reinforced concrete beams 5 placed at the slopes of the dam and those 6 placed in the body of the dam.



**Fig. 13. The ground dam with anti-seismic belts.**  
**a) cross section of the dam b) section A-A**

The elements of the edge cells of anti-seismic belt are made of utilized tires of large automobiles joined to each other with frame work joint as pipe elements 8 with anchors. Anti-seismic belts 3 are laid into support prisms of the ground dam consecutively starting from below. The distance between the belts may reach 10-20 metres and the number of them may be various depending on the demand of designing.

When seismic forces influence the dam belts 3 accept extra stretching forces owing to cohesion with the ground of the dam. The deformation of the ground is restricted and regulated by various elements of belt 3.

Extra pore pressure is eliminated by the drainage in the belts, which work as the whole system by the help of pipe joints. Besides, tires 7 have dempfer properties and take part in reduction seismic tension.

## 9. Conclusion

The investigations carried out and technical solutions worked out let us affirm that using utilized metal-cord tires in geotechnics let partly solve not only a separate engineer-ecological problem, but also achieve technical and economical effects.

Owing to original geometrical, mechanical and physical-chemical properties of utilized metal-cord tires they can achieve higher steadiness, seismic durability, hydroisolation and corrosion protection of constructions.

## REDUCING SHRINKAGE AUTOGENOUS SELF-COMPACTING CONCRETE WITH A ZEOLITE-CONTAINING MODIFIER

A.A. Guvalov

*Azerbaijan University of Architecture and Construction, Baku, Azerbaijan Republic,  
([abbas.guvalov @ akkord.az](mailto:abbas.guvalov@akkord.az))*

**Keywords:** *modifier, high-strength concrete, autogenous shrinkage, additives.*

In the production of high-strength concrete, fine complex modifiers have found wide application. Fine mineral supplements as micro silica (MS), in conjunction with the superplasticizers have revolutionized the technology of high-strength concretes marks 1000-1200. But, despite all the positive characteristics of the MC, the cost may exceed the cost of the cement in a few times. Today, therefore, important search-tonnage mineral supplements, which in combination with superplasticizers can improve the physical and mechanical properties of concrete [1,2].

In these studies, the group of dispersed cement fillers of natural origin has been expanded, and it has been proposed to use volcanic ashes and zeolite-containing rocks — trails.

These rocks contain volcanic glass, which are aluminosilicates, which interact with the hydrolysis products during cement hardening. The rocks were ground to a specific surface  $S_{sp} = 600 \text{ m}^2/\text{kg}$ . For comparison, MS Chelyabinsk Metallurgical Plant with a specific surface area of  $3500 \text{ m}^2/\text{kg}$ , manufactured in accordance with TC 14-139-121-89 was used.

High-strength concrete was obtained by modifying its complex organic-mineral additive (OMA), consisting of a superplasticizer (naphthalene-formaldehyde type SP-1 and polyacrylsulfonesulfonate type CAC-2) and finely ground mineral component (GMC) were used as superplasticizers.

The content of GMC was taken 12,5% of the consumption of cement. The share of superplasticizer SP-1 and CAC-2 in the GMC complex, respectively, was 1 and 2% of the cement consumption [3]. When using a superplasticizer in order to increase the early daily strength of concrete with additional mixing water, a hardening accelerator  $\text{Na}_2\text{SO}_4$  was injected in an amount of 1%.

Table 1

**Kinetics of concrete strength on dispersed carriers**

N	Type and dosage of organo-mineral modifier of concrete			Strength, MPa, aged			
	filler as a substitute for 10% of cement	Na <sub>2</sub> SO <sub>4</sub>	W/T	Sump, sm	1 day	3 day	28 day
1	No filler	-	0,37	0	28	42	55
2	Volcanic ash	-	0,26	1	40	67	86
3	Trass	-	0,27	0	38	60	79
4	Micro silica	-	0,27	1	51	69	88
5	Volcanic ash	1	0,29	2	50	66	79
6	Trass	1	0,31	1	46	64	78
7	Volcanic ash	-	0,29	0	51	68	76
*							
8	Trass	-	0,31	20	44	65	73
*							

Note \* compositions when using CAC-3 with microfillers

The consumption of materials per 1 m<sup>3</sup> of concrete mix for the control composition was adopted as follows: cement - 600 kg, sand -560 kg, screenings 230, rubble - 850 kg, water 200; for compositions with OMA: cement - 540 kg, OMA - 60 kg, sand - 560 kg, screenings 230, crushed stone - 850 kg, water 130. In the studies, mobile concrete mixtures with a draft of a standard cone of about 20 cm were used. Samples were stored in normal humidity conditions at a temperature of 20°C. The performed studies confirm the high efficiency of organic-mineral modifiers for the production of high-strength concrete Table 1.

The introduction of superplasticizer in combination with dispersed fillers increases both the early daily strength of high-strength concrete and the standard at the age of 28 days. In mobile mixtures, this excess on the first day is volcanic ash - 42%,

trass - 36% and MK-46%. It is important to note that concretes obtained with the use of OMA have 1,4–1,6 times higher grade strength compared to control concretes without OMA. With the complex introduction of OMA with  $\text{Na}_2\text{SO}_4$ , daily strength is increased by 82%. The introduction of the CAC-2 superplasticizer in combination with dispersed fillers increases both the early daily strength of high-strength concrete and the standard strength at the age of 28 days.

The analysis of experimental data shows that the introduction of OMA contributes to a decrease in water absorption of concrete by an average of 20-30% relative to the control composition without additives. The water absorption of the concrete of the control composition without additives is 4,82%, with the addition of volcanic ash and trass 4,63% and 3,65%, respectively.

Table 2

### Kinetics of water absorption and indicators of porosity of concrete

Type of dispersed filler	Water absorption, %					Porosity values	
	15 minut	30 minut	60 minut	24 hours	14 day	uniformity of pore sizes, $\alpha$	average pore size, $\lambda$
No filler	2,47	3,17	3,85	4,63	4,82	0,39	4,49
Volcanic ash	1,72	2,41	2,77	4,41	4,63	0,49	1,0
Trass	1,38	1,87	2,19	3,45	3,65	0,51	1,0
Micro silica	1,27	1,44	1,71	3,12	3,24	0,3	0,48

Minimal water absorption results ( $W = 3,24$ ) were recorded for concrete modified with silica fume. High-strength self-compacting concrete has a very low water-cement ratio of mixtures (usually less than 0,3), increased cement consumption, the presence of pozzolanic additives and superplasticizers [4,5].

The kinetics of water absorption and the characteristics of the porosity of high-strength concrete with OMA were studied Table 2.

These concretes contain an insufficient amount of mixing water in order to ensure the filling of large capillaries necessary to maintain the hydration and pozzolanic reactions. In the process of cement hydration in the absence of access of external moisture (the active period of hardening of concrete), menisci occur in thin capillaries, dehydration of which creates large internal stresses — autogenous shrinkage develops. In high-strength concrete, autogenous shrinkage in absolute value approaches the moisture shrinkage of ordinary concrete and can lead to more significant cracking, as it

develops much faster and occurs in concrete when the cement stone has still low strength and modulus of elasticity.

Cracking, in turn, leads to a decrease in the strength and durability of concrete, loss of prestressing of reinforcement, deterioration of the appearance of structures. To prevent the development of autogenous shrinkage as well as shrinkage when drying high-strength concrete with a low W/C value, it is realized by partially replacing coarse aggregate with an equivalent volume of pre-saturated porous aggregate or polymer additives with high water-absorbing capacity (Superabsorbent polymers SAP), which creates water tanks in concrete [6].

For the study of autogenic shrinkage in the studies, self-compacting concrete mixtures with the use of OMA were used Table 3,4.

Compositions 1 and 2 were obtained using microsilica, and 3 and 4 were obtained by replacing part (50%) of microsilica in composition 1 with equivalent the amount of fine ground (part 3) and volcanic ash (part 4). The prepared concrete mixtures of the compositions were placed in a mold for measuring autogenous shrinkage.

Autogenous shrinkage deformations were measured for 28 days, then the samples were unformed, steel frames were glued onto their ends, and further measurements were made of concrete shrinkage deformations caused by evaporation of moisture from them (moisture shrinkage). In this case, the samples were stored in a desiccator over calcium chloride powder.

It was established that autogenic shrinkage of concrete of compositions 1, 2 characterized by the values of the water-cement ratio, respectively, 0,29 and 0,32, begins to appear quite intensively after 10-11 hours from the moment of molding (Tabl 3). It develops most intensively in concrete with the lowest value of  $W/C = 0,29$ , and by 28 hours of hardening it reaches the value  $\varepsilon = 140 \times 10^{-6}$ .

This is due to the high consumption of Portland cement, the presence of highly dispersed microsilica and low content of mixing water, which is intensively bound by cement in the process of hydration, dehydrating thin capillaries.

As the value of W/C increases, the deformations of autogenous shrinkage decrease - with  $W/C = 0,32$  by 15%. As noted above, it is possible to reduce the speed and absolute amount of shrinkage by using fillers, which allows to keep water in the interplanar capillaries. At the same time, the decrease in autogenous shrinkage is 30%.

Table 3

**Change of autogenous deformations in time**

The compositions	Water / cement ratio	Slump flow, mm	Autogenous shrinkage ( $\epsilon \times 10^{-6}$ ),						
			4hours	8hours	12hours	16hours	20hours	24hours	28hours
1	0,29	650	20	30	70	110	130	135	140
2	0,32	680	10	20	50	85	110	115	120
3	0,33	650	5	7	10	55	80	90	95

The results on the effect of OMA on the properties of self-compacting concrete are shown in Table 4.

Table 4

**Properties of self-compacting high-strength concrete**

The compositions	Water / cement ratio	Slump flow, mm	The average density of the concrete mix, kg / m <sup>3</sup>	Total shrinkage, ( $\epsilon \times 10^{-6}$ )
1	0,29	650	2428	525
2	0,32	680	2420	498
3	0,33	650	2428	435
4	0,31	650	2428	569

It was established that the total value of deformations of concrete of composition No. 1 at the age of 90 days of hardening reaches the value

$$\epsilon = 525 \times 10^{-6},$$

while the autogenous shrinkage is

$$\epsilon = 320 \times 10^{-6} - 61\%.$$

When replacing part of microsilica by the route, there is a sharp decrease in the value of autogenous shrinkage, which is

$$\epsilon = 105 \times 10^{-6}.$$

At the same time, in the process of further drying, deformations caused by moisture shrinkage develop quite intensively.

The total shrinkage deformations of composition No. 3 reach

$$\epsilon = 435 \times 10^{-6},$$



however, the proportion of deformations from autogenous shrinkage is only 24,1%.

Partial replacement of microsilica with volcanic ash (composition No. 4) also has a positive effect on the reduction of autogenous shrinkage deformations. It has been established that the partial replacement of microsilica with an equivalent consumption of finely ground filler, in particular a zeolite, provides a reduction in the deformations of autogenous shrinkage, without reducing the strength characteristics of concrete. This technology can provide low-defect, reliable and durable building structures made of concrete and reinforced concrete.

### References

1. Гувалов А.А. Влияние органоминеральных модификаторов на прочность бетона // VI Международная конференция "Прочность и разрушение материалов и конструкций". Оренбург, 2010. С. 221-225
2. Гувалов А.А., Кузнецова Т.В. Органоминеральные добавки на основе вулканического пепла Джейранчельского месторождения// Информационный научно-технический журнал «Технология бетонов», 2012, № 11-12, С. 65-67
3. Guvalov A.A. Impact of poliarilsulphonosulphonic Superplasticizer on hidration and hardening of cements SCIENCE WITHOUT BORDTERS/ Transactions of the International Academy of Science H&E. Volume 3 2007\2008. Innsburk-2009. S. 605-610.
4. Гувалов А.А. Самоуплотняющиеся высокопрочные бетоны в технологии монолитного домостроения. Сборник научных трудов института строительства и архитектуры МГСУ, по материалам Международной научно-технической конференции «Промышленное и гражданское строительство в современных условиях. М.: МГСУ, 2011, С.150-152
5. Mounanga Pierre, Bouasker Marwen, Pertue Arnaud, Perronnet Annick, Khelidj Abdelhafid. Early-age autogenous and micro/macro investigations //Mater. And Struct., 2011, v. 44, No 4, p. 749-772
6. Nnadi F., Brave C. Environmentally friendly superabsorbent polymers for water conservation in agricultural lands. J. SoilSci. Environ. Manag. 2011, 2, 206–211.

## **OIL INDUSTRY AND KHEMICAL**

### **ABOUT FINDING THE EFFECT OF STOPPING FILTRATION IN MONTMORILLONIT CLAY**

**<sup>1</sup>Gabibov F.G., <sup>2</sup>Kulchitski L.I., <sup>3</sup>Gabibova L.F.**

*<sup>1,2,3</sup>Azerbaijan Research Institute of Building and Architecture, Azerbaijan,  
E-mail: farchad @ yandex.ru*

#### **Abstract**

When studying the permeability of Ca – montmorillonit clay soil taking into account capillar osmotic flowing (under strict termostating the room where experiments are carried out) they found that after compressing the soil by loads of more than 1.6 MPa the mentioned clay gets the property of ideal semiperme membrane and filtration caused by the gradient of water pressure stops. The magnitude of the pressure reached 22.000 during our experiments. The microreological analyse with using the model of clay soil mentioned above showed that really after compressing Ca – montmorrillonit clay by the loads  $P_n=1,6-2,0$  MPa the sizes of macropores become close to the sizes of micropores. Because of that the filtrational processes stop in the clay. The filtration of water and water solutions of electrolyte in clay soil differs by its great complication and has not been studied well enough nowadays. Thin dispersed clay soil with considerable specific surface is characterized by intermolecular forces and surface processes with which the extremey low filtration property of clay soil is linked. In engineering practice the mentioned useful property is used while building anti-filtration screens and cores of hydrotechnical constructions. The problem of building reliable clay screens for the stores of poisoned wastes has become very actual recently.

Nowadays they proved [1, 2] that while filtrating through thin dispersed systems water behaves like Newton's liquid. Considerable contribution in studying laws of filtration, diffusion and osmos of clay soil were made by K. Tertsagi, S.V. Nerpin, N.F. Bondarenko, I.A. Brillling, B.F. Reltov, G.M. Berezkina, V.M. Pavilonski, I.I. Kultchitski, V.M. Goldberg and others. The rise of average viscosity of water in clay systems may be 50 per cents. They defined that the thickness of stratums of water with

changed structure close to the surface of quarts in capillaries is equal to several nanometers [2].

Clay soil has the same property [1, 3]. Here boundary stratum of water show non-Newton's behaviour (within the limits of possible mistakes of measure) studying the velocity of filtration of water ( $V_f$ ) in thin pores of glass membranes with the average radius of pores of 1-5 nm showed [2], that within the limits of accuracy of experiments the velocity of filtration is described by Darsi's law:

$$V_f = K_f I, \quad (1)$$

here

$K_f$  – the coefficient of filtration;  $I$  – gradient of head.

Sometimes some deviations from the law may be watched and they enter the initial gradient  $I_0$ . Then

$$V_f = K (I - I_0) \quad (2)$$

and when  $I \leq I_0$  the liquid does not flow. There is no single idea of having the initial gradient of filtration in clay soils and this problem is not settled yet.

In some works (for example, N.F. Bondarenko [4]) they mention the being of the initial gradient, and in other ones (for example, V.M. Pavlonski [5]) they declare the lack of the initial gradient.

Different authors give different explanations of the nature of the initial gradient of filtration. In their review works of western investigators I.R. Mitchell and J.S. Yamger (1967) pointed out the following explanations:

1) non-Newton's behaviour of water, quazicrystalline structure; 2) electrokinetics osmos; 3) migration of colloidal fractions in the stream, corking of pores; 4) the growth of bacteria; 5) interaction of receding and rising meniscus, littering the capillary.

Y.M. Sergeev and others [6] explain the existence of the initial gradient in clay soil by filling narrow pores between fractions with pellicled bound water closing free water in larger pores, and its further moving during the increase of gradient of pressure.

Some time ago the character of the initial gradient of filtration in clay soil was linked to the fact that water has limited displacement both inside and in the border layers accordingly  $r_0=10^{-8}$  N/sm<sup>2</sup> and  $r_0=10^{-7}$  N/sm<sup>2</sup>.

But, however, under a stricter consideration of the problem the effect of the initial gradient watched during filtration is connected with the influence of capillary osmos [1,7,8]. Because of the lack of that the filtration in pored bodies in which the radius of

pores reaches 1 Nm obeys Darsi's law and the relation  $V_f(I)$  found from experiments is linear and gets through the origin of coordinate.

Declining from linearity may take place because of the swelling of clay soil which should be considered while finding the relation  $V_f(I)$  from experiments.

It is known that when the solutions of electrolyte flow through thin pored bodies and clay soil under the influence of gradient of pressure filtration and capillar and osmotic streams usually act at the same time. The velocity of filtration may change when in the porous body there appears the opposite or the same directioned capillar and osmotic stream. In the first case the opposite stream breaks filtration which leads to declination from Darisi's law and the emergence of the effect of the initial gradient. It is supposed that the filtration of water solutions in such clay soil may considerably be changed because of the change of the balance of surface forces and the structure of the boundary layers of water and diffusion adsorbic layers of ions [2].

In order to take into consideration the phenomena of carrying water and water solutions through clay soil they offered various methods according to which they separately found summary velocity of watercarrying through clay soil and osmotic carrying under the influence of given values of gradients of pressure, concentration and temperature with further entering the corresponding amendments [1]. Thus, these methods are very hard to use, demand special unusual equipment and do not let use the dynamics of the development of filtrational osmotic processes in clay soil.

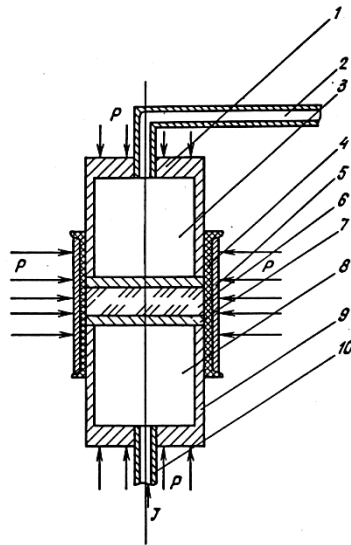
We have worked out the method of finding the velocity in clay soil corresponding to the gradient of pressure with the help of standard device YUIK-1 m little improved [9]. Moreover they model not only geostatic and layer pressure which is foreseen by means of the construction of the device, but also the difference between the concentrations of electrolytes on metallic both the sides of the sample tested.

Because of that metallic plungers transferring buttend pressure of the oily press to the sample and having the axial canal in the centre to bring and take away the tested liquid are substituted (fig. 1) by plungers-cameras 1 and 9 with perforated buttend 7 made of plexiglass. They pour the tested solutions of various concentrations to make the gradient of concentration at the same time at the entrance to sample 6 the certain hydrostatic pressure is made to conduct filtrational tests. This way they measure summary velocity of water running through the sample of the soil by means of gradients of water pressure and concentration of electrolytes.

The whole method of finding the coefficient of filtration in clay soil meaning osmotic streams is the following. The sample of soil in the shape of a cylinder 6 with height 1-5 sm and diameter 35 sm is placed in a rubber cuff 4 being in perforated fushing 5. With the help of the oil press they do the all over compression of the sample which is equal or less than its natural compression. The butennnd compression is conducted by the hollow plungers. 1 and 9 they bring the solutions of the electro lyte with required

concentration into the cavities 3 and 8. At the same time the working liquid having increased or reduced (comparing with the working water at the entrance) concentration of salets is given to the outlet of the sample (camera 3) which causes capilar osmotic streams flowing through the sample of soil. Simultaneously at the entrance across the canal of bringing branch pipe 10 they make the certain hydrostatic pressure in cavity 8 of plunger 9 to conduct filtrational tests.

When the concentration of electrolyte in cavity 3 of plunger becomes more than the one in cavity 8 of plunger 9 the direction of ostnotic stream through the sample is the same as that of filtriation stream. When the concentration of electrolyte in cavity 8 of plunger 9 is more than that in cavity 3 of plunger 1 the direction of osmotic stream is the opposite to filtration one. The velocity of the flowing of the water in the sample of soil  $V_{sum}$  is found according to volume per second of the electrolyte in graduated capillary 2 joined to branch pipe at the outlet of plunger 9 during the certain intervals. The velocity and direction of osmotic stream is found as following.



**Fig.1. The sheme of modernized knot with the sample of tested soil in filtrational device YUPK-1 m for simultaneous measure of velocities of filtrational and capillary osmotic streams in clay soil.**

They make the diagram  $V_{sum}(I)$  as it is shown on fig.2. That diagram shown as a straight line 1 or 2 is extrapolated as far as crossing the ordinate axis. Then they measure the segment of the straight line cut in the axis of velocity of diagram  $V_{sum}(I)$  when  $I=0$ . The measured magnitude will characterize the velocity of osmotic stream  $V_{osm}$ . When

the directions of filtration and osmotic streams (straight line 2) are opposite to each other, the point of the crossing of the straight line  $V_{sum}(I)$  will be in the negative branch of the axis of velocity.

The fragment cut off by the straight line  $V_{sum}(I)$  in the axis  $I$  as it is seen in fig.2, characterizes the magnitude of the “initial gradient” of filtration. Under the considered gradient of water pressure  $I_0$  there is an equality

$$V_f = -V_{osm} \quad (3)$$

The quantity  $I_0\ell$  where  $\ell$  is the thickness of the membrane is equal to the osmotic pressure of ideal semipermeable membrane

$$\Delta P_0 = I_0 L = RT\Delta C, \quad (4)$$

here  $R$  – gas constant,  $T$  – absolute temperature,  $\Delta C$  – the difference of concentrations.

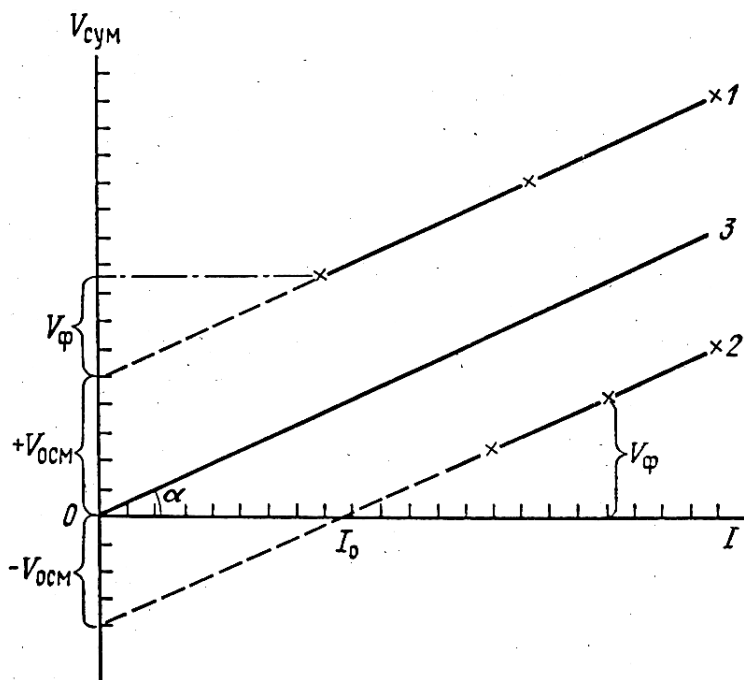
The real velocity of filtration  $V_f$  is characterized by straight line 3, and the coefficient of filtration  $K_f$  is equal to tangence of the angle  $\alpha$  of the straight line. It is calculated considering the amendments to the velocity and direction of the osmotic stream in clay soil by means of the formula

$$K_f = \frac{V_{sum} \pm V_{osm}}{I} \quad (5)$$

here the sign “+” is taken in the case if the direction of filtrational and osmotic streams are the same; the sign “-”, correspondingly, is taken when they are the opposite.

Our investigations show that not considering the velocity of osmotic streams in salted clay soil while calculating the coefficient of filtration brings to reducing or increasing the results approximately twice as much. Moreover, they noticed that the more the density of clay soil is (the less the pores are) the more the intensity of osmotic processes grows [10].

When studying the permeability of Ca – montmorillonit clay soil fig.3 taking into account capillar osmotic flowing (under strict thermostating the room where experiments are carried out) they found that after compressing the soil by loads of more than 1.6 MPa the mentioned clay gets the property of ideal semipermeable membrane and filtration caused by the gradient of water pressure stops. The magnitude of the pressure reached 22.000 during our experiments.



**Fig.2. Graphic way of defining the amendment to the velocity and direction of osmotic stream in clay while calculating the coefficient of filtration: 1 – the same directions of both filtrational and osmotic streams 2 – the opposite directions of filtrational and osmotic stream; 3 – dependence  $V_f(I)$ .**

The analyse of a number of investigations of changing the porosity of various clay soils done by V.M. Golderg and N.P.Skvortsov [11], showed that the magnitudes of porosity may be quite big. Those magnitudes of porosity are corresponding to the porosity of waterholding sandy ground and even considerably more than that.

The repeated experiments let us declare that in spite of quite big magnitude of porosity of Ca – montmorillonit after compressing by the loads of 1,6 MPa, for the first time we found the phenomenon of stopping filtration in montmorillonit clay unknown before.

The experiments showed that the anormal phenomenon mentioned above is not watched in caolinit fig.4 or illit fig.5 soils. If basing on the physical and chemical model of clay soil worked out by the authors earlier [12] fig.6 in which the pores formed in the

contacts of elementary fractions are micropores, flat through macropores pierce through the system and filtration is formed just in macropores.

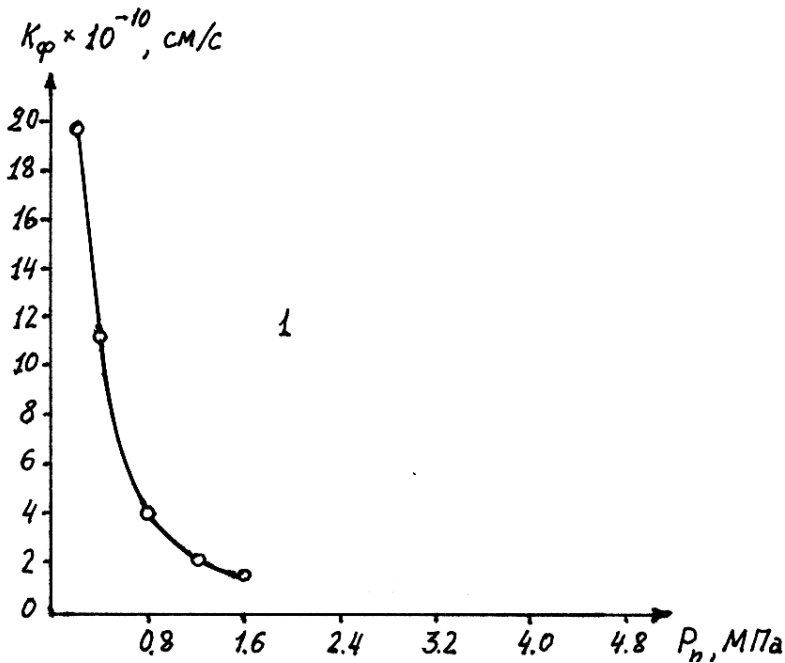


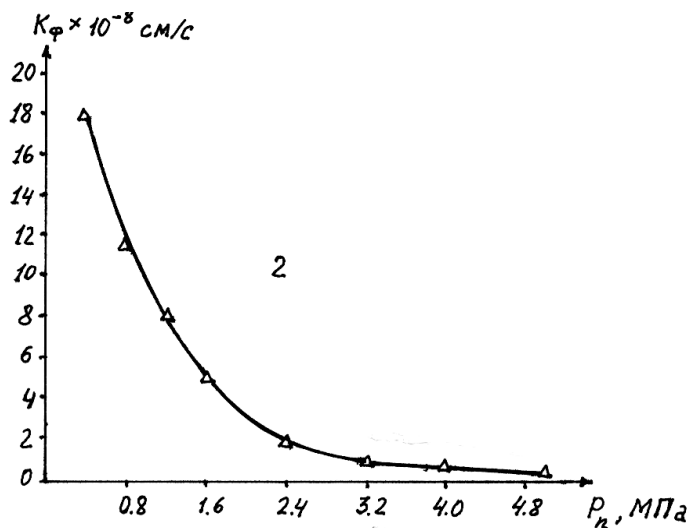
Fig.3. Dependence of the coefficient of Ca – montmorillonit on the pressure of beforehand compressing.

Micropores cannot participate in filtration as the liquid being there is tied by the active surface of clay fractions, it participates only in diffusional and osmotic processes. The absolute microporosity of Ca-montmorillonit is considerably more than that of Ca – illit and kaolinit mainly because of internal aggregate (interlayer) microporosity. The increase of microporosity being compressed because of covering the extremal basis of microagregates is the common for all aggregated clays. The calculations of the model show that completing the intensive reduction of macroporosity of Ca – montmorillonit is corresponding to reaching the maximum of microporosity of clay being compressed by loads of  $P_n \approx 1,6$  MPa.

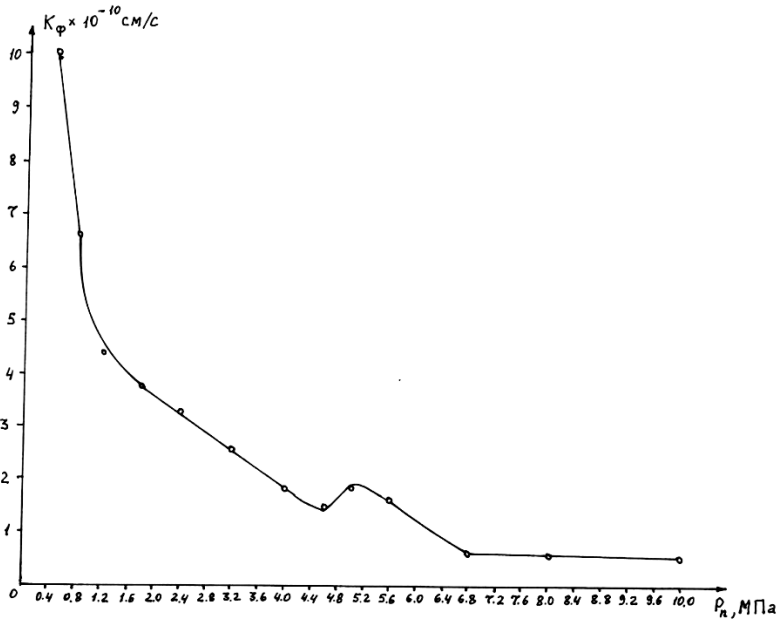
In fig.7 they represent the dependence of the size of macropores of various clay on compressing load. It is shown that when the load is  $P_n \approx 1,6$  MPa the size of macropores of Ca – montmorillonit reaches 100 Å, Ca – illit and Na – kaolinit this



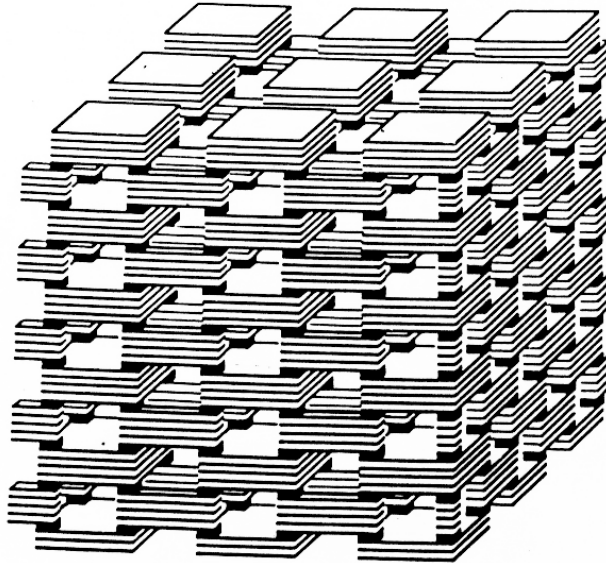
parameter is 2,5÷3 times as much even when the load is  $P_p=4,0$  MPa. The microreological analyse with using the model of clay soil mentioned above showed that really after compressing Ca – montmorrillonit clay by the loads  $P_n=1,6-2,0$  MPa the sizes of macropores become close to the sizes of micropores. Because of that the filtrational processes stop in the clay. It gains the properties of semi-permeable body. In fig.8 they represent the scheme of the movement of microfactions (or microaggregates) relatively to each other after compressing them in horizontal flatness. In this figure it is obviously seen when the fraction moved on to each other the contact surface (micropores) increases and through macropores become less.



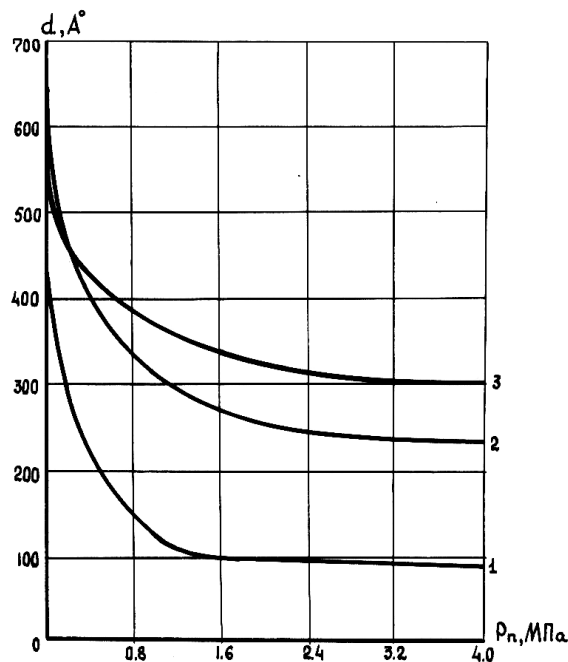
**Fig.4. Dependence of the coefficient of filtration of Na – kaolinit on the pressure of beforehand compressing.**



**Fig.5. Dependence of the coefficient of filtration of Ca – illit on the pressure of before hand compressing.**

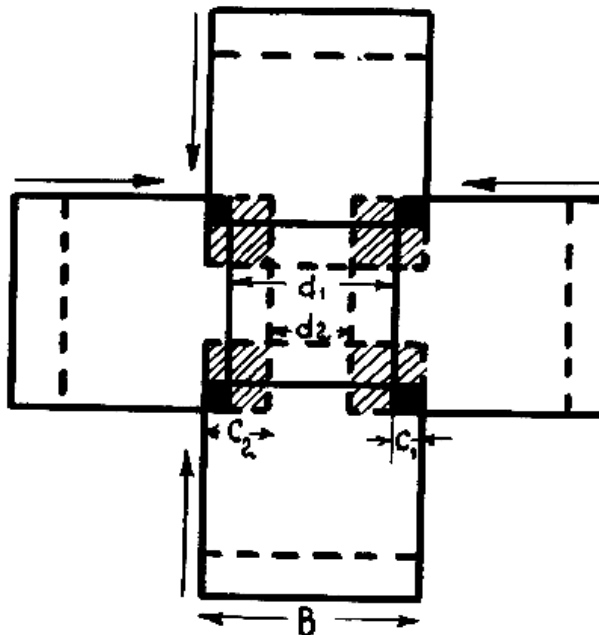


**Fig.6. The model of two-phased clay soil of coagulative structure.**



**Fig.7. Dependence of the size of macropores in two-phased monomineral clay on the compressing load:  
1 – Ca – montmorillonit; 2 – Ca – illit; 3 - Na – kaolinit.**

Montmorillonit fractions have the least coefficient of surface friction which let them come maximum close to neighbour fractions in the tangential (horizontal) direction after compressing and the macropores reach the size of micropores linking the water being there by the surface forces. Therefore, the water being in the macropores lessened to the size of the micropores cannot take part in filtration. The effect mentioned above is not watched in illit or caolinit clays because of comparingly high coefficient of surface friction between the microfractions of the clay minerals mentioned.



**Fig.8. The scheme for explaining the geometry of changes of micro-and macropores in horizontal surface of the model while compressing two-phased clay: B – the width of microfractions or microaggregates;  
 $d_1$  and  $d_2$  – changing diameters (sizes) of macropores;  
 $C_1, C_2$  – changing sizes of contact surfaces of microfractions (micropores).**

### References

1. Brillig I.A. Filtration in clay soils. Observational information, series "Hydrogeology and engineering geology", M., VIEMS, 1984, 60 p.
2. Deryagin B.V., Churayev N.V., Muller V.M. Surface forces. M., "Nauka", 1987, 398 p.
3. Kultchitski L.I., Usyarov O.Q. Physical and chemical basis of forming properties of clay soil. M., "Nedra", 1981, 180 p.
4. Bondarenko N.F. Physics of movement of underground waters. Leningrad, "Filydrometeoizdat", 1973, 215 p.
5. Pavilonski V.M. About the problem of initial gradient in clay soil. Works of "VODGEO", issue 19, M, 1968, p. 26-31.
6. Sergeev Y.M. and others. Ground studying M., the Publishing House of Moscow University, 1971, 596 p.
7. Deryagin B.V., Zorin Z.M., Sobolev V.D., Churayev N.V. The properties of thin layers of water close to solid surfaces". In the book: "Tied water in

- dispersed systems” Issue 5, M., Publishing house of Moscow University, 1980, p. 4-13.
8. Gabibov F.G., Kulchitski L.I. Studying the nature of the initial gradient of filtration in clay soil”. The works of the 1-st Central Asian Geotechnical symposium, volume 1, Astana, 2000, p. 367-368.
  9. Kalipko M.K. The method of studying collectoric properties of kerns. M., “Gostoptechizdat, 1973, 224 p.
  10. Kulchitski L.I., Gabibov F.G., Tkachenko U.G. Finding permeability of clay “Razvedka okhrana nedr”, N10, 1986, p. 54-58.
  11. Goldberg V.M., Skvortsov N.P. Permeability and filtration in clay. M., “Nedra”, 1986, 160 p.
  12. Kulchitski L.I., Usyarov O.Q., Gabibov F.G. Physical and chemical model of water filled clay and its usage while studying volumetrical deformations of clay soil. Baku, AzR I of B and A, 2000, 41 p.

International Council For Scientific Development  
INTERNATIONAL ACADEMY OF SCIENCE  
H&E



**SCIENCE WITHOUT BORDERS.**  
**Transactions of the International Academy of Science H&E.**  
**Vol. 4, Innsbruck, SWB, 2017/2019, 701 p.**

---

**International Publishing House “Science Without Borders” (SWB)**

**Meinhardstrasse 10, A-6020 Innsbruck, Austria,**

**e-mails:** [walter.kofler@ias-he.com](mailto:walter.kofler@ias-he.com)

[prof.khalilov@ias-as.org](mailto:prof.khalilov@ias-as.org)

[www.ias-icsd.org](http://www.ias-icsd.org)

[www.ias-as.org](http://www.ias-as.org)

*Date of an order: 01.04.2019*

*Order: 08/019*

*Size: 70×100/16*

*Offset printing*

**ISSN 2070-0334**  
**ISBN - 978-9952-451-04-7**





**ISSN 2070-0334**

**ISBN - 978-9952-451-04-7**